

**INVESTIGATION OF THE CHALLENGER  
ACCIDENT**

---

**R E P O R T**

**OF THE**

**COMMITTEE ON  
SCIENCE AND TECHNOLOGY  
HOUSE OF REPRESENTATIVES**

**NINETY-NINTH CONGRESS  
SECOND SESSION**



**OCTOBER 29, 1986.—Committed to the Committee of the Whole House on  
the State of the Union and ordered to be printed**

---

**U.S. GOVERNMENT PRINTING OFFICE**

## COMMITTEE ON SCIENCE AND TECHNOLOGY

DON FUQUA, Florida, *Chairman*

ROBERT A. ROE, New Jersey  
GEORGE E. BROWN, Jr., California  
JAMES H. SCHEUER, New York  
MARILYN LLOYD, Tennessee  
TIMOTHY E. WIRTH, Colorado  
DOUG WALGREN, Pennsylvania  
DAN GLICKMAN, Kansas  
ROBERT A. YOUNG, Missouri  
HAROLD L. VOLKMER, Missouri  
BILL NELSON, Florida  
STAN LUNDINE, New York  
RALPH M. HALL, Texas  
DAVE McCURDY, Oklahoma  
NORMAN Y. MINETA, California  
BUDDY MacKAY,\*\* Florida  
TIM VALENTINE, North Carolina  
HARRY M. REID, Nevada  
ROBERT G. TORRICELLI, New Jersey  
RICK BOUCHER, Virginia  
TERRY BRUCE, Illinois  
RICHARD H. STALLINGS, Idaho  
BART GORDON, Tennessee  
JAMES A. TRAFICANT, Jr., Ohio  
JIM CHAPMAN, Texas

MANUEL LUJAN, Jr.,\* New Mexico  
ROBERT S. WALKER, Pennsylvania  
F. JAMES SENSENBRENNER, Jr.,  
Wisconsin  
CLAUDINE SCHNEIDER, Rhode Island  
SHERWOOD L. BOEHLERT, New York  
TOM LEWIS, Florida  
DON RITTER, Pennsylvania  
SID W. MORRISON, Washington  
RON PACKARD, California  
JAN MEYERS, Kansas  
ROBERT C. SMITH, New Hampshire  
PAUL B. HENRY, Michigan  
HARRIS W. FAWELL, Illinois  
WILLIAM W. COBEY, Jr., North Carolina  
JOE BARTON, Texas  
D. FRENCH SLAUGHTER, Jr., Virginia  
DAVID S. MONSON, Utah

HAROLD P. HANSON, *Executive Director*  
ROBERT C. KETCHAM, *General Counsel*  
REGINA A. DAVIS, *Chief Clerk*  
R. THOMAS WEIMER, *Republican Staff Director*

---

### CHALLENGER ACCIDENT REPORT STAFF TASK GROUP

ROBERT C. KETCHAM, *General Counsel*  
RADFORD BYERLY, Jr.  
RONALD E. WILLIAMS  
PATRICIA G. GARFINKEL  
A. SCOTT CROSSFIELD  
CAROLYN C. GREENFELD  
DAVID D. CLEMENT  
SHIRLEY J. WATSON

ROBERT E. PALMER  
GEORGE S. KOPP  
HARRY S. DAWSON, Jr.  
HARRIET J. SMITH  
NELSON L. MILDNER  
CAROLYN J. RADABAUGH  
JAMES PAUL  
GLORIA J. DUNDERMAN

---

\*Ranking Republican Member.

\*\*Serving on Committee on the Budget for 99th Congress.

## LETTER OF SUBMITTAL

---

U.S. HOUSE OF REPRESENTATIVES,  
*Washington, DC, October 29, 1986.*

Hon. THOMAS P. O'NEILL, Jr.,  
*The Speaker of the U.S. House of Representatives, Washington, DC.*

DEAR MR. SPEAKER:

By direction of the Committee on Science and Technology, I hereby submit the Committee's investigative report on the Challenger accident. The report was approved by the Committee on October 7, 1986. The report was carried out under the direction of the Ranking Majority Member, Robert A. Roe, who chaired the hearings and instructed the Committee staff assigned to the investigation.

Sincerely,

DON FUQUA, *Chairman.*

Enclosure.



## LETTER OF TRANSMITTAL

---

U.S. HOUSE OF REPRESENTATIVES,  
COMMITTEE ON SCIENCE AND TECHNOLOGY,  
*Washington, DC, October 29, 1986.*

*To Robert A. Roe, Ranking Majority Member, Committee on Science  
and Technology.*

DEAR MR. CHAIRMAN:

I am forwarding this investigative report on the Challenger Accident prepared at your request.

On your instructions, the staff has carefully reviewed the information made available to the Committee and prepared the necessary findings and recommendations. The task was enormous and has been done in a careful and painstaking manner. I am especially grateful to all the staff which is listed on the inside cover of the report for their professional and thorough application to this important report. We worked in a collegial manner and on a completely bipartisan basis. I particularly want to thank the three group leaders, Ron Williams, Terry Dawson and Harriet Smith who headed up the respective subgroups for the Accident, the Technical, and the Management Issues.

Sincerely,

ROBERT C. KETCHAM, *General Counsel.*



# CONTENTS

	Page
I. INTRODUCTION .....	1
II. CONCLUSIONS .....	3
III. COMPILATION OF ISSUES, FINDINGS, AND RECOMMENDATIONS .....	9
IV. BACKGROUND .....	35
V. THE ACCIDENT .....	39
A. Introduction .....	39
B. Solid Rocket Motors .....	50
1. History .....	50
2. Summary of Casing Joint Design .....	60
3. Testing and Certification .....	64
4. Manufacturing .....	64
5. Stacking Operations .....	65
6. Summary of Launch Operations .....	68
7. Retrieval, Transportation, and Refurbishment .....	73
C. External Tank .....	74
D. Crew Survival .....	76
E. Sabotage .....	79
F. Additional Avenues of Investigation .....	79
VI. DISCUSSION OF CRITICAL ISSUES .....	85
A. Technical Issues .....	85
1. Hardware Development and Production .....	85
a. Problems in Hardware Certification .....	85
b. Recurrent Hardware Problems .....	92
c. Other Engineering Concerns .....	99
d. Desirable Tests Not Yet Approved .....	101
e. Production/Refurbishment Issues .....	105
f. Review of NASA's Redesign/Recertification Plan .....	109
2. Operations .....	114
a. Shuttle Processing Issues .....	114
b. Pressures on Shuttle Operations .....	119
c. Impact of Pressures on Shuttle Operations .....	122
d. Other Safety Issues .....	132
B. Management Issues .....	138
1. Technical Management .....	138
a. Risk Management Issues .....	138
b. Launch Decision Process .....	144
c. Technical Expertise of Personnel .....	154
d. Change Control Process .....	161
2. Organization and Policy Management .....	165
a. Management Structure .....	165
b. Communication .....	170
c. Safety, Reliability, and Quality Assurance .....	174
d. Contractor Incentives .....	179
VII. CASING JOINT DESIGN .....	183
VIII. LAUNCH OPERATIONS .....	207
IX. DEFINITION OF TERMS AND ACRONYMS .....	253
X. APPENDICES .....	255
V-A .....	255
V-B .....	260
V-C .....	273
V-D .....	275
V-E .....	277
V-F .....	283

## VIII

	Page
V-G.....	285
V-H.....	286
V-I.....	288
V-J.....	290
VI-A.....	292
VI-B.....	319
VI-C.....	321
VI-D.....	327
VII-A.....	369
VII-B.....	376
VII-C.....	278
VIII-A.....	280
VIII-B.....	384
VIII-C.....	387
VIII-D.....	393
VIII-E.....	395
VIII-F.....	406
VIII-G.....	417
VIII-H.....	425
VIII-I.....	428
VIII-J.....	434
VIII-K.....	438
VIII-L.....	442



# Union Calendar No. 600

99TH CONGRESS }  
2d Session }

HOUSE OF REPRESENTATIVES

{ REPORT  
{ 99-1016

---

## INVESTIGATION OF THE CHALLENGER ACCIDENT

---

OCTOBER 29, 1986.—Committed to the Committee of the Whole House on the State of the Union and ordered to be printed

---

Mr. FUQUA, from the Committee on Science and Technology,  
submitted the following

### R E P O R T

#### I. INTRODUCTION

On January 28, at 11:39 a.m., the Space Shuttle Challenger and its crew suffered a tragic accident during launch. That same day the House of Representatives adopted H. Res. 361 which expressed the profound sorrow of the House for the tragedy and offered condolences to the families of the Challenger crew members.

During consideration of the resolution Chairman Fuqua informed the full House of Representatives that, in conformance with its oversight responsibilities, the Committee on Science and Technology would conduct a comprehensive investigation into the cause of this accident.

This report is the result of the Committee's inquiry. It contains the best efforts of the Committee to review the work of the Presidential Commission on the Space Shuttle Challenger Accident (hereafter referred to as the Rogers Commission) and the work of the National Aeronautics and Space Administration (NASA) in investigating the causes of the accident, and reviewing the recommendations to resume safe flight.

In addition to reviewing the five volumes of the Rogers Commission Report, the Committee also had direct on-line access to the entire Rogers Commission data base, which included full-text and document retrieval capability.<sup>1</sup>

The findings and recommendations contained in this report are the product of the Committee's own extensive hearing record,

---

<sup>1</sup> *Report of the Presidential Commission on the Space Shuttle Challenger Accident*, Volumes I-V, Washington, D.C., June 6, 1986. (Hereafter referred to as Rogers Commission Report.)

which includes materials submitted for the record, staff investigations, interviews, and trips.

It should be understood that the role of this Committee is different from that of the four-month Rogers Commission. The Committee, which authorized the funds and reviewed the lengthy development process which led to the successful Shuttle program, has a responsibility to insure that the tragic accident, and those events that led up to it, are understood and assimilated into all levels and activities of NASA so that safe manned space flight can be resumed.

In carrying out its annual authorizing responsibilities, the Committee endorses the programs and activities of NASA, and functions as a key player in the legislative activities of our federal system. As part of the fulfillment of this role, the Committee has reviewed the report of the Rogers Commission, called upon numerous witnesses, and utilized many members of its staff to prepare and review the material that has produced this report.

The Committee has been most fortunate in its work due to the diligent and thorough investigation undertaken by the Rogers Commission and the NASA investigation panels that supported the Commission. The Commission's exhaustive efforts to achieve completeness as it came to grips with a very complex technical and management system are very commendable, and will serve as a model for future Presidential Commissions.

The Committee wishes to express its appreciation for the assistance of the House Administration Committee, the Rogers Commission staff, and the Justice Department's Office of Litigation Support, Civil Division. Each of these groups was very cooperative and helpful in providing the access to, and equipment for, the Challenger accident data base needed by the Committee to do its work. In addition, the Committee very much appreciates the assistance of NASA personnel who responded to numerous requests for briefings and documents during the course of the investigation.

## II. CONCLUSIONS

In execution of its oversight responsibilities, the Committee on Science and Technology has conducted a thorough investigation of the Challenger accident. Although the Committee's concern and evaluation in this report are related specifically to the safe and effective functioning of NASA's Space Shuttle program, it should be understood that our larger objective and greater responsibility are to insure that NASA, as the Nation's civilian space agency, maintains organizational and programmatic excellence across the board.

What we as a Committee, NASA as an agency, and the Nation as a whole, also must realize is that the lessons learned by the Challenger accident are universally applicable, not just for NASA but for governments, and for society. We hope that this report will serve this much larger purpose.

The Committee's investigation included: ten formal hearings involving 60 witnesses; an extensive review of the report of the Rogers Commission along with its voluminous supporting appendices and related reports by the investigation panels at NASA, as well as numerous briefings and interviews with NASA officials, contractor personnel, outside experts, and other interested parties.

From the outset, the focus of the Committee's investigation has been on understanding each of the following:

What was the cause, or causes, of the Challenger accident?

Are there other inherent hardware or management-related deficiencies that could cause additional accidents in the future?

What must be done to correct all of these problems so that the Space Shuttle can be safely returned to flight status?

The Committee found that NASA's drive to achieve a launch schedule of 24 flights per year created pressure throughout the agency that directly contributed to unsafe launch operations. The Committee believes that the pressure to push for an unrealistic number of flights continues to exist in some sectors of NASA and jeopardizes the promotion of a "safety first" attitude throughout the Shuttle program.

The Committee, the Congress, and the Administration have played a contributing role in creating this pressure. Congressional and Administration policy and posture indicated that a reliable flight schedule with internationally competitive flight costs was a near-term objective.

Pressures within NASA to attempt to evolve from an R&D agency into a quasicompetitive business operation caused a realignment of priorities in the direction of productivity at the cost of safety.

NASA management and the Congress must remember the lessons learned from the Challenger accident and never again set unreasonable goals which stress the system beyond its safe functioning.

The Committee commends the work of the Rogers Commission and its supporting panels at NASA. Their investigation and the reports that document their efforts are very broad in scope and exceptionally detailed considering the time that was available to accomplish their task.

As a rule, the Committee agrees with the findings reached by the Rogers Commission. However, there are areas where the Committee either disagrees with a Rogers Commission finding or with the relative importance that the Rogers Commission attached to that finding.

Like the Rogers Commission, the Committee concluded that the Challenger accident was caused by a failure in the aft field joint on the right-hand Solid Rocket Motor. Additionally, we agree with the Rogers Commission that this tragic accident was not caused by the Orbiter, the Space Shuttle Main Engines, the External Tank, the onboard payloads, the ground support equipment, or the other elements of the Solid Rocket Boosters. We also agree that the failure of the joint was due to a faulty design, and that neither NASA nor Thiokol fully understood the operation of the joint prior to the accident. Further, the joint test and certification programs were inadequate, and neither NASA nor Thiokol responded adequately to available warning signs that the joint design was defective.

In concurrence with the Rogers Commission, the Committee confirms that the safety, reliability, and quality assurance programs within NASA were grossly inadequate, but in addition recommends that NASA review its risk management activities to define a complete risk management program. The Committee also agrees that a thorough review must be conducted on all Criticality 1 and 1R items and hazard analyses; a study should be conducted on how to provide Space Shuttle crews with a means of escape during controlled gliding flight; and NASA's Shuttle management structure, safety organization, communications procedures, and maintenance policies should be carefully scrutinized and improved.

In other areas, the Committee reached somewhat different conclusions than the Rogers Commission:

The Rogers Commission concluded that NASA's decision-making process was flawed. The Committee does agree that the Marshall Space Flight Center should have passed along to higher management levels the temperature concerns that Thiokol engineers raised the night before the launch of Mission 51-L. However, the Committee feels that the underlying problem which led to the Challenger accident was not poor communication or inadequate procedures as implied by the Rogers Commission conclusion.<sup>1</sup> Rather, the fundamental problem was poor technical decision-making over a period of several years by top NASA

---

<sup>1</sup> For the purpose of this report, a procedure is a formal set of instructions designed to guide and assist in the performance of a technical or management function.

and contractor personnel, who failed to act decisively to solve the increasingly serious anomalies in the Solid Rocket Booster joints.

Information on the flaws in the joint design and on the problems encountered in missions prior to 51-L was widely available and had been presented to all levels of Shuttle management. Despite the presence of significant amounts of information and the occurrence of at least one detailed briefing at Headquarters on the difficulties with the O-rings, the NASA and Thiokol technical managers failed to understand or fully accept the seriousness of the problem. There was no sense of urgency on their part to correct the design flaws in the SRB. No one suggested grounding the fleet, nor did NASA embark on a concerted effort to remedy the deficiencies in O-ring performance. Rather, NASA chose to continue to fly with a flawed design and to follow a measured, 27-month, corrective program.

The Committee has more concerns than those expressed by the Rogers Commission about the relative safety of the Space Shuttle Main Engine. We are impressed by the sophistication and performance of the Main Engine, but are concerned that it may have inadequate safety margins to ensure continued safe operation. The Committee is also concerned by the presence of persistent operating problems with the engine (e.g., cracked turbine blades and defective hydraulic actuators and temperature sensors), and believes that NASA should give serious consideration to not allowing the Main Engine to be operated (except in emergency situations) at a thrust level greater than the standard 104 percent. On the other hand, should NASA determine that a higher engine thrust setting is needed for programmatic reasons, the Committee believes that the space agency should take whatever actions are required to ensure that adequate operating margins are present to maintain safety.

The Committee has gone beyond the Rogers Commission in recommending a new system specification to overcome the inadequacies of the landing gear, tire, wheel, brake and nose wheel steering systems. The Committee also concluded that orbiter landings appear to be high risk even under ideal conditions, which seldom occur.

The Rogers Commission stated that "there appears to be a departure from the philosophy of the 1960s and 1970s relating to the use of astronauts in management positions."<sup>2</sup> In contrast, after taking testimony from several former and current astronauts, the Committee could find no evidence that astronauts are denied the opportunity to enter management if they so choose. On the other hand, prior to the STS 51-L accident, astronauts were not encouraged to enter management.

---

<sup>2</sup> Rogers Commission Report, Volume I, p. 199.

In still other areas, the Committee has raised concerns that do not appear to have been addressed sufficiently by the Rogers Commission. We are concerned that:

There are numerous other recurrent hardware problems that are either not fully understood by NASA or have not been corrected.

The existing internal communication system is disseminating too much information, often with little or no discrimination in its importance. Accordingly, recipients have difficulty "separating the wheat from the chaff."

Existing contract incentives used by NASA do not adequately address or promote safety and quality concerns—most emphasis is placed on meeting cost and schedule requirements.

NASA does not yet understand how or why the deficiencies in Solid Rocket Motor testing and certification went undetected in spite of the very comprehensive processes and procedures used by the agency to conduct and oversee these activities. The Committee is concerned that without such an understanding, NASA will not be able to protect against a similar breakdown in its system of checks and balances in the future.

The Committee has concerns regarding the safety of the Filament Wound Case Solid Rocket Booster now under development by NASA, and recommends that the agency consider moving the heaviest Space Shuttle payloads to expendable launch vehicles so that there will be no need to use Filament Wound Case Boosters.

The Committee is not assured that NASA has adequate technical and scientific expertise to conduct the Space Shuttle program properly. NASA has suffered staffing reductions in key areas over several years. Moreover, it loses a significant number of technical/scientific personnel due to an imbalance between the government salary schedule and that of the private sector. The salary structure also inhibits NASA's ability to recruit top technical talent to replace its losses. The record is not sufficient to warrant a formal finding on this matter. However, the Committee intends to conduct an in-depth review of NASA technical ability in the next Congress.

On July 14, 1986, NASA submitted to the President a report on what actions the space agency plans to take in response to the recommendations of the Rogers Commission.<sup>3</sup> The Committee believes that the plans contained in this report are a step in the right direction. When fully implemented, these plans should substantially improve the safety of Space Shuttle flight operations. The Committee also endorses NASA's decision to move the proposed date for the next Space Shuttle launch beyond June 1987. This is a realistic and responsible decision that has removed some unnecessary pressure

---

<sup>3</sup> NASA, "Report to the President: Actions to Implement the Recommendations of the Presidential Commission on the Space Shuttle Challenger Accident," July 14, 1986. (Hereafter referred to as NASA Response to Rogers Commission.)

from the government and contractor personnel who must ensure that all hardware will be in readiness to reinstitute safe flight operations.

Throughout the remainder of this report, the Committee addresses dozens of specific issues that relate to the Challenger accident. The Committee makes many recommendations for actions to be taken on the part of NASA to correct the problems that we have identified. The Committee directs NASA to report back to us by February 15, 1987, on how it is responding to each recommendation contained in this report.

In closing, the Committee would like to state that it continues to believe in and remains committed to a vigorous civilian space program. The Committee also continues to believe that the Space Shuttle is a critically important element of that program. The Committee's purpose, as NASA's primary overseer in the House, must be to monitor, understand, and help correct where necessary the patterns in NASA which lead to weakened and ineffective operation.

We are at a watershed in NASA's history and the Nation's space program. NASA's 28-year existence represents its infancy. We must use the knowledge and experience from this time to insure a strong future for NASA and the U.S. space program throughout the 21st century.

This Committee has long been proud of the many awe-inspiring achievements of NASA and understands the importance of NASA's programs to the future well-being of this country. We as a Committee have perhaps exhibited the human inclination to accept the successful completion of a flight or event as an indication of the overall strength of all aspects of its planning and execution. Perhaps it is arrogant to dissect and interrogate relentlessly projects and programs that bring home repeated A's for achievement and accomplishment. However, all of us—NASA, the Committee, the Congress and the Nation—have learned from the Challenger tragedy that it is wisdom to do so, and it is a reflection of respect for the human fallibility that we all possess.

We have no doubt that through the hard work and dedication of the men and women at NASA and its supporting contractors, the Space Shuttle will be safely returned to flight status—and will once again continue to impress people around the world with its many important accomplishments.

As has been said many times since the January 28th tragedy, space flight is a high risk undertaking. The Committee accepts this fact and applauds those men and women who, in spite of this risk, have chosen manned space flight as a career. Though we grieve at the loss of the Challenger crew, we do not believe that their sacrifice was in vain. They would not want us to stop reaching into the unknown. Instead, they would want us to learn from our mistakes, correct any problems that have been identified, and then once again reach out to expand the boundaries of our experience in living and working in outer space.





### III. COMPILATION OF ISSUES, FINDINGS, AND RECOMMENDATIONS

This compilation is taken from the body of the report. In order to facilitate the reader's ability to refer to specific sections within the report, the outline in the following compilation corresponds to the Table of Contents and the body of this report:

#### V. THE ACCIDENT

##### A. INTRODUCTION

##### *Discussion Only*

##### B. SOLID ROCKET MOTORS

###### 1. History

###### *Issue*

Was there sufficient time to correct the problems with the Solid Rocket Motor?

###### *Findings*

1. Problems with the joints which connect the Solid Rocket Motor casings were recognized for many years. While attempts were made to correct these problems, the measures taken were insufficient to provide a reliable joint.

2. The joint seal problem was recognized by engineers in both NASA and Morton Thiokol in sufficient time to have been corrected by redesigning and manufacturing new joints before the accident on January 28, 1986. Meeting flight schedules and cutting cost were given a higher priority than flight safety.

###### 2. Summary of Casing Joint Design

###### *Issue*

Why did the aft field joint between the steel containers that hold the Solid Rocket Motor propellant fail to contain the burning gases of the propellant during lift-off and flight operations?

###### *Findings*

1. The design of the field joint was unsatisfactory and could not reliably contain the burning propellant gases under the range of operating conditions to be expected during the lift-off and flight phases.

2. The O-ring materials and putty used in the design of the joint were unsatisfactory as used on the Shuttle, particularly during the winter months. Furthermore, neither NASA nor its contractor, Morton Thiokol, can adequately control the quality or consistency of these kinds of materials, which are made from recipes known

only by the manufacturer and which can be changed without certification and approval.

### *Recommendations*

1. NASA should write and issue a new and more accurate performance specification which would cover the full range of thermal and structural requirements for the Solid Rocket Motors, with an adequate factor of safety for unusually low temperatures.

2. The Committee concurs with the Rogers Commission Report Recommendations on new joint design, but believes it is more appropriate to be more explicit in identifying the weaknesses in the joint design that need correction.

3. The field joints of the Solid Rocket Motors should be redesigned to account for the following features while providing a significant factor of safety:

- a. Movement in the joint,
- b. Proper spacing between tang and clevis,
- c. Seals made to withstand high and low temperatures under all dynamic thermal and structural loadings,
- d. Adequate sealing without the use of putty,
- e. Protection against insulation debonding and propellant cracking.

3. Testing and Certification

### *Discussion Only*

4. Manufacturing

### *Discussion Only*

5. Stacking Operations

### *Issue*

Was there any damage to the casing joints or contamination that occurred during the stacking operations when the Shuttle was assembled in the Vehicle Assembly Building (VAB) that could have contributed to the failure?

### *Finding*

There was no evidence of joint contamination, fracture or other damage from foreign objects or due to casing ovality that contributed to the joint failure. Although certain problems occurred during stacking and the procedures were violated once, there was no evidence that these events contributed to the Flight 51-L accident.

6. Summary of Launch Operations

### *Issue 1*

How was the decision to launch STS 51-L arrived at and why was it wrong?

### *Findings*

1. The Flight Readiness Review for STS 51-L was conducted in accordance with established procedure.

2. The decision to launch STS 51-L was based on a faulty engineering analysis of the SRM field joint seal behavior.

3. Compounding this erroneous analysis were serious ongoing weaknesses in the Shuttle Safety, Reliability and Quality Assurance Program which had failed to exercise control over the problem tracking systems, had not critiqued the engineering analysis advanced as an explanation of the SRM seal problem, and did not provide the independent perspective required by senior NASA managers at Flight Readiness Reviews.

4. The initial response of Marshall managers to the attempts of Thiokol engineers to raise the issue of temperature effects on the SRM seals caused Thiokol management to discount proper technical concerns and engineering judgment in their recommendation to launch.

5. The Director of Marshall's Shuttle Projects Office may have violated NASA's Flight Readiness Review policy directive by failing to report the results of the January 27th teleconference to the Associate Administrator for Space Flight.

6. The decision of the STS Program Manager to launch despite the uncertainty represented by ice on the Fixed Service Structure was not a prudent effort to mitigate avoidable risks to the Shuttle.

7. The Launch Director failed to place safety paramount in evaluating the launch readiness of STS 51-L.

8. No launch should have been permitted until ice was cleared from the platform leading to the pad escape system.

9. Ice Team personnel and Rockwell contractors properly conveyed their inability to predict the post-ignition behavior of ice.

10. Post-flight analysis indicates that ice did not exhibit the behavior predicted by analysis, and that ice traversed a distance sufficient to strike the Shuttle during liftoff.

11. Failure to enforce a clear requirement for definite readiness statements contributed to failures in communication between NASA and its contractors during launch preparations.

### *Issue 2*

Should firing room personnel be allowed to waive launch commit criteria or equipment redlines during a launch countdown without a well-developed technical reason for doing so?

### *Finding*

NASA's management waived its own launch commit criteria on January 28, 1986, without a valid technical reason for doing so.

### 7. Retrieval, Transportation and Refurbishment

### *Issue*

Were the motor casings used on STS 51-L damaged as a result of the retrieval, transportation and refurbishment operations following previous launches?

### *Finding*

There was no evidence of damage to the casings or joint due to prior use or preparation for reuse.

## C. EXTERNAL TANK

*Issue*

The External Tank was obviously involved in the accident. Was that involvement a cause or an effect?

*Findings*

1. The Committee adopts the "Finding" of the Rogers Commission that: "A review of the External Tank's construction records, acceptance testing, pre-launch and flight data and recovered hardware, does not support anything relating to the External Tank which caused or contributed to the cause of the accident."

2. The External Tank ruptured under the forces of a failed Solid Rocket Booster motor. These forces were far outside of any possible design considerations that could have been applied to the External Tank.

## D. CREW SURVIVAL

*Issue*

Was the accident of STS 51-L on January 28, 1986, survivable?

*Finding*

In the case of the tragic loss of the Space Shuttle Challenger and her crew on January 28, 1986, the Committee is convinced that the accident was not survivable.

## E. SABOTAGE

*Issue*

Could the accident have been caused by sabotage, terrorism, or foreign covert action?

*Finding*

The Committee is convinced that there is no evidence to support sabotage, terrorism or foreign covert action in the loss of the Challenger.

## F. ADDITIONAL AVENUES OF INVESTIGATION

*Issue*

Could the accident have been caused by some failure other than failure of the joint between the casings?

*Finding*

As of September 15, 1986, the Committee has not found any credible evidence to support any cause of the Challenger accident, other than the failure of the aft casings joint in the right-hand Solid Rocket Booster. Nor has there been any substantial evidence of a secondary or parallel failure on Flight 51-L.

## VI. DISCUSSION OF CRITICAL ISSUES

## A. TECHNICAL ISSUES

## 1. Hardware Development and Production

*a. Problems in Hardware Certification**Issue 1*

Have all elements of Space Shuttle flight hardware been adequately certified?

*Findings*

1. The overall design and certification processes prescribed by NASA for each major element of Space Shuttle flight hardware are very comprehensive.

2. Prior to the STS 51-L accident, in spite of the comprehensive nature of NASA's prescribed design and certification processes, insufficient testing had been conducted to permit an adequate understanding by either Morton-Thiokol or NASA regarding the actual functioning of the Solid Rocket Motor joint. Also, the Solid Rocket Motor had not been adequately certified to meet the natural and induced environmental conditions that are stated in NASA's design standards. The issue of whether or not standards were adequate is discussed in Section VII.

3. The deficiencies in Solid Rocket Motor testing and certification persisted in spite of many reviews of the program by panels of experts: (1) within the manufacturer; (2) within NASA; and (3) from independent, outside groups.

4. These deficiencies in testing and certification of one major element of the Space Shuttle system raise the possibility that other elements of flight hardware (or other sub-elements of the Solid Rocket Motor) could have similar deficiencies.

5. If NASA is unable to explain why the deficiencies in Solid Rocket Motor testing and certification went undetected by the existing comprehensive set of processes and procedures, the agency will not be able to protect against a similar breakdown in its system of checks and balances in the future.

*Recommendations*

1. NASA should devote more attention to determining why the deficiencies in Solid Rocket Motor testing and certification went undetected, so that appropriate action can be taken to uncover latent problems in existing hardware and to prevent similar problems in future development programs.

2. NASA and its contractors should thoroughly reassess the adequacy of all the testing and certification that has been conducted to date on each element of Space Shuttle flight hardware. Where deficiencies are found, they must be corrected.

*Issue 2*

Does the Space Shuttle Main Engine have adequate operating margins, and is the "fleet leader" concept adequate to ensure safe operation?

### *Findings*

1. The Space Shuttle Main Engine is an impressive, technological achievement. However, it also is one of the higher risk elements of the Space Shuttle system. Anomalous component performance or premature engine shutdown could prove catastrophic to the Space Shuttle and its crew.

2. Some NASA officials familiar with the Space Shuttle Main Engine believe that it should be operated at a throttle setting of 109 percent only in an emergency; others believe the engine could be safely operated at 109 percent on a routine basis.

3. It is widely accepted that the Space Shuttle Main Engine would be safer if its operating margins (for temperature, pressure, operating time, etc.) were increased.

4. The Committee agrees with the sense of Dr. Feynman's concerns with respect to NASA's current "fleet leader" concept for certifying Space Shuttle Main Engine components, such as high pressure turbopumps, for flight.

5. On a case by case basis, NASA regularly violates its own certification requirements by permitting individual engine components to be used for flight even though they have accumulated an operating time in excess of 50 percent of the two fleet leaders (i.e., in violation of the "2X" rule).

### *Recommendations*

1. NASA should continue its active development program for the Space Shuttle Main Engine. The program should be focused more on increasing operating margins.

2. Because of the safety concerns raised by some knowledgeable officials, NASA should give serious consideration to restricting use of the 109 percent engine throttle setting to emergency situations only. If NASA decides that it needs to use the 109 percent throttle setting for other than emergency situations, the space agency should take whatever actions are required to ensure that adequate margins are present to maintain safety.

3. NASA should closely scrutinize each of the concerns raised by Dr. Feynman regarding the agency's "fleet leader" concept for certifying Space Shuttle Main Engine components. The agency should also closely reassess its practice of selectively violating its "2X" rule for some Main Engine flight hardware elements.

#### *b. Recurrent Hardware Problems*

##### *Issue*

What resolutions of inadequacies revealed in the landing gear, tires, wheels, brakes, and nose wheel steering of the landing and deceleration system are required?

##### *Findings*

1. The Orbiter landing gear, tires, wheels, brakes, and nose wheel steering, as a system, is experimental, designed to criteria outside any other experience, and uses unique combinations of materials. The original design performance specifications for speed and landing weights are routinely exceeded. The original design

did not consider asymmetrical braking for cross wind steering as the normal case, although it has become standard practice. Stresses which were not taken into account in the design have surfaced in as yet a very small real world sample.

2. As a consequence, Orbiter landings appear high risk even under ideal conditions, which seldom occur. Exceptional procedural and skill demands are placed upon the pilots to nurse the brakes and tires through every landing. Landing rules have had increasing constraints imposed that hamper operational flexibility and usefulness of the Orbiter.

3. Brake and tire damage have been evident since early on in the program. The Rogers Commission seems very correct in finding the current landing gear system unacceptable. Resolution of landing gear system problems can no longer be put off.

### *Recommendations*

The Committee recommends that NASA:

1. Assemble all of the fragmented studies, analyses, and conclusions on landing gear problems and integrate them into one engineering description of the system as it is now intended to be used. This should include consideration of the basic strength of the struts themselves and their attachments.

2. Write a new system specification and match the proposed design improvements to an acceptable reliability and certification specification.

3. Design a test and certification program adequate to meet criteria to fly and to continue well into future operations until understanding and confidence in the landing gear system is attained.

4. In anticipation of requirements for a new brake specification, accelerate a program to provide:

Increased brake mass and/or heat sink,

Substantial increase in energy absorption,

Evaluation which weighs the experimental nature of the proposed 65 million foot pound carbon brake and its impact on the system against the penalty of weight of known materials (e.g. steel) for operational confidence.

5. Write updated subsystem specifications to upgrade the landing gear system to acceptable levels of performance to respond to the Rogers Commission's recommendations.

### *Issue 2*

What actions should be taken relative to other recurrent problems with flight hardware?

### *Finding*

There have been many instances of in-flight anomalies and failures of other elements of Space Shuttle hardware, some involving mission critical pieces of equipment. Some of these past problems have been corrected while others have not.

### *Recommendation*

NASA should ensure that before reinstating Space Shuttle flight operations, it fully understands and has corrected all in-

stances of serious in-flight anomalous behavior or failures involving mission critical pieces of flight hardware.

*c. Other Engineering Concerns*

*Issue*

What action should be taken relative to other engineering concerns regarding critical elements of Space Shuttle flight hardware?

*Finding*

In recent years, serious engineering concerns have been raised regarding the safety of some elements of Space Shuttle flight hardware, such as the 17 inch flapper valve and the heat exchanger feeding the liquid oxygen tank.

*Recommendations*

1. NASA should ensure that, as a part of its current review of Space Shuttle safety, it identifies, thoroughly evaluates, and then takes appropriate action on all serious engineering concerns raised regarding mission critical elements of Space Shuttle flight hardware.

2. NASA should give special attention to both the cost and risks of using Filament Wound Case Solid Rocket Boosters for very heavy Space Shuttle payloads versus the cost and programmatic impacts of simply transferring those payloads to expendable launch vehicles.

*d. Desirable Tests Not Yet Approved*

*Issue 1*

Is the current ground test program for the SSME adequate to provide a complete understanding of the engine's operating characteristics and safety margins?

*Findings*

1. The Committee supports the Findings and Conclusions of the Development and Production Team concerning the SSME, particularly the concern that "Hardware availability and the potential of damage to hardware and facilities resulting from tests malfunctions have constrained . . . [full margin] . . . testing during the ground test program."

2. The Committee shares Dr. Feynman's concern that there has been a slow shift toward decreasing safety in the SSME program.

3. There is not a sufficient understanding of SSME blade cracks and fractures.

*Recommendations*

1. The Committee concurs with the Development and Production Team conclusion that overtesting, limits testing, and malfunction-testing in the SSME program should be re-emphasized to demonstrate full engine capability.

2. NASA should prepare and submit to the Committee a cost-benefit analysis of testing a SSME to destruction including: (a) uti-



lizing additional SSME test stands; (b) utilizing additional hardware for the ground test program; and (c) the value of such a test.

3. A vigorous study of fracture behavior should be conducted to minimize the hazard of cracked SSME blades and to increase the reliability and safety margin of blades. New blades and/or new policies for duration of blade use should be incorporated prior to the next Shuttle launch.

#### *Issue 2*

Is the leak/combustion threat of the External Tank's hydrogen pressure valve a hazard warranting testing?

#### *Findings*

1. The Committee supports the Rogers Commission concern regarding the hazard posed by the liquid hydrogen vent and relief valve.

2. The Committee supports the intent of the ET prime contractor, Martin Marietta, to pursue outdoor wind tunnel testing to eliminate the liquid hydrogen vent/relief valve hazard.

#### *Recommendation*

NASA, in conjunction with the appropriate contractor, should consider designing and conducting an ET liquid hydrogen leak/burn test to determine if corrective actions should be taken prior to the next Shuttle flight.

#### *Issue 3*

Does the present Range Safety System (RSS) on the External Tank present an unreasonable risk?

#### *Finding*

There is substantial controversy over the relative benefits and risks of the present RSS on the External Tank.

#### *Recommendation*

The Committee believes the Administrator should prepare and submit to the Committee a comprehensive review of RSS requirements.

#### *e. Production/Refurbishment Issues*

#### *Issue 1*

Should 100 percent X-ray inspection of the propellant and insulation for the Solid Rocket Motors (SRM) be resumed?

#### *Findings*

1. Previous X-ray inspection led to only one SRM being rejected for Shuttle use.

2. There is no non-destructive inspection method which can guarantee a defect-free SRM. X-ray inspection cannot detect "kissing" voids in which the SRM insulation is touching the SRM steel casing but is not bonded to it. Debonded insulation at the end of an SRM segment could provide burning propellant gases with a path to the SRM steel casing and could result in loss of vehicle and

crew. X-ray inspection can detect propellant cracks and large voids which if undetected could also result in a catastrophic situation.

3. Although there is no guarantee that X-ray inspection has been a particularly effective method of detecting propellant and insulation SRM flaws, it remains one of the best available methods to monitor the SRM manufacturing process.

#### *Recommendations*

1. NASA should consider reinstating full X-ray inspection of the propellant and insulation for all motors used on succeeding flights until new, more accurate inspection methods can be developed and implemented and there is unquestionable confidence in the SRM production process.

2. NASA, in conjunction with the appropriate contractors, should investigate the development of new, more accurate inspection techniques which can detect "kissing" voids and other potential defects that cannot be detected by X-ray inspection.

#### *Issue 2*

Are all production and other activities involving Criticality 1 and 1R hardware at prime and secondary contractor facilities labeled as "critical" processes?

#### *Findings*

1. Critical processes are formally identified and controlled by NASA. All processes are classified and controlled by the contractor's Process Change Control Board.

2. The O-ring used in the case joint is critical to the sealing integrity of the joint, yet it is not designated as a "critical" process by either the Parker Seal Co. or Hydrapack, the manufacturer and supplier respectively. This raises the possibility that other Criticality 1 and 1R hardware components are also not appropriately designated by their manufacturer as "critical" processes.

#### *Recommendations*

1. NASA should require the manufacture of critical items, such as the O-rings, to be designated "critical" processes. Contractors should formally notify their employees involved in critical manufacturing processes of the serious nature of particular production processes.

2. NASA should conduct a thorough review to ensure that all manufacturing processes involving Criticality 1 and 1R hardware components of prime and secondary contractors are appropriately designated "critical" processes.

#### *Issue 3*

Do O-ring repairs compromise safety?

#### *Finding*

The Committee supports the Development and Production Team Finding and Conclusion that the "limit of five repair joints per O-ring is an arbitrary number" and that "repair of inclusions and voids in the rubber . . . appears to be an area of potential problem."

### *Recommendation*

NASA should review its O-ring repair policy and contractor repair practices in terms of their effects on O-ring performance and safety. Such review should be completed prior to the resumption of Shuttle flights if, as anticipated, the new SRB joint design uses O-rings.

### *Issue 4*

What impact does growth of SRM case size have upon booster and Shuttle performance and safety?

### *Finding*

The Committee concurs with the Development and Production Team Finding that "Remeasurement of two used SRM case segments indicated both tang and clevis sealing surfaces have increased in diameter beyond the anticipated design limits."

### *Recommendation*

NASA and the appropriate contractor should resolve through analysis and testing prior to the next Shuttle flight the cause of SRM case size growth and its impact upon booster and Shuttle performance, reliability of refurbished SRM case segments, and safety.

### *f. Review of NASA's Redesign/Recertification Plan*

#### *Issue*

Is NASA's SRM redesign and hardware recertification plan a viable and realistic one which will result in a safer, more reliable Space Transportation System?

#### *Findings*

1. NASA's SRM redesign plan is a step in the right direction. Moving the proposed launch date beyond June 1987 is a responsible and realistic decision. The membership of the SRM Redesign Team is representative of qualified individuals in and outside of NASA. With the expert assistance of the specially appointed National Research Council (NRC) Independent Oversight Group, the new SRM design should be a significantly safer and more reliable Shuttle element.

2. NASA's current hardware recertification plan is also a step in the right direction. The use of independent review contractors distinguishes this recertification plan from earlier reviews. However, given the failure of previous reviews to discover the deficient SRB joint certification, the Committee is concerned there is still the possibility that the recertification effort may not reveal other certification deficiencies, if indeed they exist. The plan also raises concern about the qualifications of independent reviewers to evaluate certain elements given the uniqueness of particular Shuttle components.

3. The joint was never fully tested as a separate element of the SRM. The various forces that act on the joint during stacking, launch, and flight are difficult, if not impossible, to duplicate in a

test of the joint under all conditions that could be experienced during launch and flight.

4. It is unclear what function the new Safety Office will perform in the redesign of the SRB field joint and other critical elements of the Shuttle, as well as NASA's recertification plan.

### *Recommendations*

1. The Committee recognizes the national need to return the Shuttle to flight status as soon as reasonably possible. As noted in NASA's July 14, 1986, report to the President, safety will determine the launch schedule. However, NASA should consider the proposed launch date of early 1988 as a flexible one which should be slipped further if necessary. The Shuttle should not be launched again until NASA can assure that safety criteria have been met.

2. In establishing a test program to certify the new Solid Rocket Motor design, NASA should consider the feasibility of including in combination and in the proper sequence all of the thermal and structural loads expected to be experienced by the Solid Rocket Motor during ignition, lift-off, and flight.

3. The independent review contractors participating in the hardware recertification plan should utilize sufficient specific technical expertise to insure adequate recertification of all elements of the STS.

4. The Committee requests that the new Office of Safety, Reliability and Quality Assurance conduct an independent assessment of the SRB field joint redesign efforts. In addition, the new office should also be integrally involved in reviewing all other critical component redesign efforts and NASA's recertification plan.

## 2. Operations

### *a. Shuttle Processing Issues*

#### *Issue*

In 1983, NASA consolidated fifteen separate contracts and awarded a single Shuttle Processing Contract (SPC) encompassing all ground processing related to launch and landing of the Space Shuttle. There are two issues associated with this contract: (1) How should be the concept of a unified SPC; and (2) How well has the SPC contractor actually performed? A related issue is the quality of essential logistical support, especially spare parts, provided to the contractor by NASA.

#### *Findings*

1. Performance under the SPC has improved since the inception of the contract. However, up to the time of the Challenger accident, contractor performance continued to be plagued by excessive overtime, persistent failures to follow prescribed work procedures, and inadequate logistical support from NASA.

2. High overtime rates have hampered SPC performance. Overtime rates had increased significantly during the six months prior to the Challenger launch, to the point that critical personnel were working weeks of consecutive workdays and multiple strings of 11 and 12-hour days. Fatigue resulting from work patterns of this sort can constitute a threat to safety. In fact, worker fatigue was a con-

tributing factor in a mission-threatening incident on Flight 61-C, the mission immediately prior to the January 28 Challenger launch.

3. There are numerous documented cases where contractor employees failed to comply with guidelines for carrying out assigned duties, including specific "Operations and Maintenance Instructions" (OMIs). Such failures contributed to both of the major mishaps in 1985 involving Shuttle processing—namely, the November 8, 1985, "handling ring" episode which led to significant damage to a Solid Rocket Motor segment slated for use on STS 51-L, and the March 8, 1985, "payload bay access platform" episode which led to significant damage to bay payload bay door. Failure to follow an OMI also led to improper (and mission-threatening) handling of the hydrogen disconnect valve during the 51-L launch operations. All of these incidents show a lack of discipline, both with respect to following prescribed procedures and with respect to reporting violations of these procedures.

4. At the time of the Challenger accident, the lack of spare parts caused a degree of cannibalization (i.e., the removal of a part from one Orbiter to satisfy a need for a spare part on another Orbiter), which was the highest in the history of the Shuttle program and which was a threat to flight schedule and flight safety. Excessive cannibalization leads to multiple installations, retesting, added documentation, delayed access to parts, and increased damage potential. As a result, cannibalization contributes directly to excessive overtime.

5. There is no clear evidence whether or not greater involvement of the development contractors would improve Shuttle operations.

### *Recommendations*

1. Because of the serious quality and safety concerns surrounding the contract, NASA should conduct a careful review of Shuttle processing, the SPC contract, and the relationship of flight hardware contractors and report its findings, recommendations, and proposed contract modifications to the Committee. NASA's reexamination should include a comparison of efficiency and safety under the SPC versus efficiency and safety during pre-1983 Shuttle processing operations, which heavily involved the development contractors.

2. NASA should examine the issues of spares availability and cannibalization and provide the Congress with a management and budgetary plan for correcting previous logistical problems.

3. NASA should stop routine cannibalization and develop guidelines (including appropriate control and review procedures and roles for the SR&QA office) governing permissible cannibalization.

4. The Committee recommends that NASA provide its re-invigorated safety office with the authority to enforce scheduling that leads to safe overtime rates.

### *b. Pressures on Shuttle Operations*

#### *Issue*

Was NASA under pressure to fly more flights? How did this pressure originate? Will it recur?

### *Findings*

1. The Congress and the Executive Branch jointly developed the policy that the Space Shuttle should, in a reliable fashion and at an internationally competitive cost, provide for most of the Free World's space launch needs. By and large, both Branches failed to appreciate the impact that this policy was having on the operational safety of the system.

2. NASA was under internal and external pressure to build its Shuttle flight rate to 24 per year, primarily to reduce costs per flight, but also to demonstrate and achieve routine access to space. NASA has never achieved its planned flight rate.

### *Recommendations*

1. NASA must not attempt to achieve a flight rate beyond that which (1) can be supported by the budget and staff resources available; and (2) is consistent with the technical maturity of the Shuttle and the flexibility desired and needed in scheduling payloads. Management should ensure efficient use of resources but should not impose a flight rate on the system.

2. Once operation of the Space Shuttle resumes, the Committee should maintain a close and continuous oversight of Shuttle flight rate, planning, and operations. The Committee should ensure both that flight rate flows logically from the resources provided and that flight safety is not compromised beyond acceptable limits.

#### *c. Impact of Pressures on Shuttle Operations*

### *Issue*

Did operating pressures adversely affect the safety of the Shuttle program?

### *Findings*

1. The pressure on NASA to achieve planned flight rates was so pervasive that it undoubtedly adversely affected attitudes regarding safety.

2. The pressure to achieve planned flight rates was compressing mission preparation as earlier missions were delayed due to unforeseen problems. Had the accident not occurred there would soon have been a collision between planned launch dates and mission preparation needs which could not have been met by overtime, cannibalization, or other undesirable practices. Operating pressures were causing an increase in unsafe practices.

3. The schedule of payloads planned to fly on the Shuttle (the manifest) was frequently changed. Each change rippled through the NASA Shuttle organization and through the manifest and, especially if made shortly before launch, would increase the demands on personnel and resources in order to achieve the planned flight rate.

4. The Space Shuttle has not yet reached a level of maturity which could be called operational as that term is used in either the airline industry or the military. Each Shuttle flight is fundamentally unique, and requires unique preparations. Therefore, small changes in a mission can cause significant perturbations of mission planning and crew training.

### *Recommendations*

1. The new Associate Administrator for Safety, Reliability and Quality Assurance must assure that any pressures to increase the Shuttle flight rate do not adversely influence mission preparation. The Associate Administrator must have the authority not only to stop a particular flight, e.g., at a Flight Readiness Review, but to stop the whole mission planning process if necessary.

2. Where appropriate, NASA should take steps to make the mission planning process standard and routine to reduce the time and resources needed to plan a mission. Before requesting more resources for the existing mission planning process (manpower, facilities, equipment), NASA should identify ways to improve the process.

#### *d. Other Safety Issues*

##### *Issue 1*

What is the criticality of landing safety associated with programmed and abort landing sites and their local characteristics?

##### *Findings*

1. The Committee finds that many of the normal and abort landing safety problems will be alleviated when the Rogers Commission's and the Committee's (Section VI. A. 1. b., this report) recommendations to upgrade the landing gear system are implemented. When the landing gear system is understood, straightforward calculations and operational rules will determine acceptable runway dimensions and conditions.

2. The Committee found no reason to fault NASA's current procedure on launch constraints based upon operational judgment and conservative rules on local conditions at planned abort and landing sites. However, since an obvious finding is that the Orbiter is a developmental system, it is axiomatic that unanticipated "dicey" circumstances will arise.

3. It was found that for the least landing gear system stress, runway preference is Edwards Air Force Base (EAFB) (concrete), KSC, and Rogers Dry Lake (EAFB "lake bed") in that order. No reason was found to invalidate the KSC runway design. The reasons for the "dry" course surface still prevail over concern about wear on tires designed for one landing. Additional constraints at KSC because of lesser lateral stabilized overrun area may be needed to bring its safety to the level of the EAFB runway.

4. The NASA Landing Safety Team's proposal to provide standard landing aids and arresting barriers at all sites and their emphasis on runway surface characteristics for repetitive tire use takes on a new dimension that is in addition to the Rogers Commission's recommendations.

5. Weather, by far, is the most significant factor governing operational decisions, Orbiter damage, and landing safety. The constraint is simply that acceptable weather must be forecast with confidence within the time frame needed. Ultra-conservative rules prevail because of the predictable unpredictability of Cape weather. New and innovative local weather analysis and forecasting re-

search is a high priority. The African Coast and southwestern United States sites enjoy more stable and predictable weather.

### *Recommendations*

The first priority to achieve an acceptable degree of landing safety and to have a sensible base to work from for improvement is to implement the recommendations of the Rogers Commission and the Committee on the landing gear system improvements to attain an operational capability. Then:

Instrument the system, and schedule all landings at Edwards runway for systematic concurrent testing until the landing gear system is understood.

Write a clean sheet set of rules based on results.

Determine the risk of accident with the B-747 Shuttle Carrier Aircraft (SCA) and its impact upon the Shuttle program.

Extend every reasonable effort to assure a mission planning process to minimize the need for abort site landings.

Reevaluate and determine the degree of risk acceptable at abort site landings and bring abort site capability up to meet that risk level.

Expand astronaut matched team flight landing practice to cover all known exigencies. Propose additional training craft if necessary.

Join in a venture with NOAA to invent new technology and techniques to learn new ways to understand the dynamics of Cape Kennedy weather phenomena to supplant current inadequacy to forecast two hours ahead.

### *Issue 2*

Has adequate provision been made for crew safety in case of in-flight emergencies? That is, has adequate provision been given to launch abort options and crew escape options?

### *Findings*

1. Crew escape options were considered when the Shuttle was originally designed and the basic situation has not changed. Many initially attractive options do not significantly reduce risk to the crew either because they may not reduce exposure to the principal hazards or because they add risks of their own.

2. A crew escape system for use in controlled gliding flight might be feasible and worthwhile.

3. Crew escape during the ascent phase appears infeasible.

4. Launch abort during SRB burn appears impossible but it may be possible to decrease risk to the crew after SRB separation, primarily through mission design.

### *Recommendation*

NASA should continue to respond to the recommendations of the Rogers Commission regarding (i) crew escape during controlled gliding flight and (ii) increasing the possibility of successful emergency runway landings. NASA should reexamine all crew survival options and report to the Committee on its findings.



## B. MANAGEMENT ISSUES

## 1. Technical Management

*a. Risk Management Issues**Issue*

Is there a coordinated and effective risk management program in the NSTS?

*Findings*

1. NASA does not explicitly use a centralized program that coordinates all the factors that encompass an adequate risk management program.

2. As a result of the accident, NASA is reexamining the Failure Modes and Effects Analyses (FMEA) and Hazard Analyses (HA) to reassess risks associated with the designs of Shuttle subsystems.

3. NASA's lack of statistical data on the performance of certain components will limit the usefulness of sound engineering judgment in much the same way as it limits the usefulness of probabilistic risk assessment.

*Recommendations*

1. NASA should develop and provide to the Committee a description of an overall risk management program as it relates to the Space Shuttle. This effort should include a determination of whether or not a more centralized coordination of a risk management program and issuance of direct risk management guidance directives are needed.

2. NASA should review analytical methods utilized in the performance of risk assessment, including statistical analyses, trend analyses and probabilistic risk assessment methodologies to determine their applicability to the NSTS program. Assistance from the National Academy of Sciences, or other appropriate organizations with expertise in these matters, may be required to adequately perform this review.

3. NASA should review its certification testing to ensure that all critical items are adequately tested. Data obtained from these tests should be used when appropriate in conducting a formal risk assessment.

*b. Launch Decision Process**Issue 1*

Is the process for establishing launch constraints and dealing with them effective?

*Findings*

1. There is no clear understanding or agreement among the various levels of NASA management as to what constitutes a launch constraint or the process for imposing and waiving constraints.

2. Launch constraints were often waived after developing a rationale for accepting the problem rather than correcting the problem; moreover, this rationale was not always based on sound engineering or scientific principles.

### *Recommendations*

1. NASA should establish rigorous procedures for identifying and documenting launch constraints. The individual(s) responsible for implementing this procedure should be clearly identified, and well defined and understood criteria for waiving them should be established.

2. NASA should exercise extreme caution in waiving launch constraints before correcting the problem that led to the launch constraint. The rationale should be based on rigorous scientific/engineering analyses or tests and should be understood and accepted by the program manager.

### *Issue 2*

Are the Launch Commit Criteria procedures adequate to ensure the safety of the mission?

### *Findings*

1. The procedure used for developing launch commit criteria is systematic and thorough; however, violations of the criteria do not necessarily mean "no go". Therefore, NASA sometimes has relied on engineering judgments made during the terminal countdown in determining whether to launch.

2. Launch commit criteria were sometimes waived without adequate engineering analysis or understanding of the technical reasons for establishing the criteria.

### *Recommendations*

1. NASA should review the launch commit criteria procedures, especially those for dealing with violations, to lessen the reliance on engineering judgments under stress.

2. When situations arise where "real time" judgments are unavoidable, NASA should adopt a more conservative approach to waiving previously established criteria. In no case should a criterion be waived without a thorough understanding of the rationale for the establishment of the criterion.

### *Issue 3*

Are launch readiness review procedures and communications adequate?

### *Finding*

The Committee finds that the review procedures and communications used to assure flight readiness were systematic, thorough, and comprehensive and provided ample opportunity for surfacing hardware problems prior to flight. Level I FRRs are usually recorded (audio); however, there is often no record made of other key pre-launch meetings.

### *Recommendation*

NASA should make every reasonable effort to record meetings where key decisions might be made; in particular, all formal Flight Readiness Reviews, including the L-1 and the Mission Management Team meeting should be recorded, where feasible by video.

*Issue 4*

Was the failure to inform the Level I or Level II Program Managers of the Teleconference involving NASA and Morton Thiokol on the eve of the launch a factor in the decision to launch?

*Findings*

1. The Committee finds that Marshall management used poor judgment in not informing the NSTS Program Manager or the Level I Manager of the events that took place the night before the launch, specifically the stated concerns of the Thiokol engineers. However, the Committee finds no evidence to support a suggestion that the outcome would have been any different had they been told.

2. The Committee finds the efforts of Thiokol engineers to postpone the launch commendable; however, Thiokol had numerous opportunities throughout the normal flight readiness process following flight 51-C in January 1985 to have the new minimum temperature criteria established.

*Issue 5*

Do the principal contractors have an appropriate role in the launch decision making process?

*Finding*

The principal contractors have an active role throughout the decision making process right up to the launch; however, the lack of a firm requirement for their concurrence at the time of launch does partially relieve them of responsibility for mission success.

*Recommendation*

Principal contractors should be required to make a clear, unambiguous statement concerning launch readiness just prior to launch.

*Issue 6*

Are astronauts adequately represented in the decision making process?

*Finding*

The astronauts believe they currently have the opportunity to make inputs into the process and are reluctant to assume a greater responsibility for the decision to launch.

*c. Technical Expertise of Personnel**Issue*

Does NASA have an adequate level of in-house technical expertise to manage the Shuttle Program properly?

*Findings*

1. During the last decade NASA has had significant decreases in manpower. A disproportionate reduction may have occurred in the safety, reliability and quality assurance staff at NASA headquarters and at the Marshall Space Flight Center. Additionally during the period preceding the Challenger accident, the Office of Space

Flight also suffered a decline in staff. The decreases may have limited the ability of those offices to perform their review functions.

2. The information presented to NASA headquarters on August 19, 1985 was sufficient to require immediate and concentrated efforts to remedy the joint design flaws. The fact that NASA did not take stronger action to solve this problem indicates that its top technical staff did not fully accept or understand the seriousness of the joint problem.

#### *Recommendations*

1. NASA should review the numbers and qualifications of key staff in technical and management positions and should consider additional training and recruitment of individuals to further the quality and safety of NASA's missions.

2. The Committee should maintain on-going oversight of this analysis and conduct an in-depth examination upon the conclusion of NASA's review.

#### *d. Change Control Process*

##### *Issue 1*

Has the pressure to maintain operational flight rates and schedules for the Shuttle compromised the hardware Change Control Process?

##### *Findings*

1. When NASA declared the Space Shuttle to be an operational system, additional pressure to increase flight rates impacted other aspects of the overall program such as the ability to implement, evaluate, test, and certify changes in hardware design.

2. As a result of attempting to operate the Shuttle at increased flight rates, controlling other aspects of the program such as the flight production process and manifest also became a more complex and difficult aspect of program administration.

#### *Recommendations*

1. NASA must reconsider its efforts to categorize the Shuttle as an operational transportation system.

2. The Configuration Management System designed to control such changes must be reexamined by NASA as to its effectiveness in assuring that all hardware changes take place in a safe and reliable fashion.

##### *Issue 2*

Is the change control process sufficiently defined for all elements of the Shuttle system?

##### *Findings*

1. The NSTS engineering and process change guidelines are, for the most part, sufficiently well-defined for the majority of the sub-systems that comprise the Space Shuttle.

2. NASA gives the same level of scrutiny to changes involving a minor component (such as moving velcro strips in the Orbiter) as those involving mission critical elements of flight hardware.

*Recommendation*

NASA should review its change control process to determine the usefulness of differentiating between minor changes and significant changes.

## 2. Organization and Policy Management

*a. Management Structure**Issue 1*

Does the management of the Shuttle Program adequately define the lines of authority and are managers given authority commensurate with their responsibilities?

*Finding*

The management of the Shuttle Program is complex and diversified and it is not always clear who has authority or responsibility. NASA's "lead center" concept has resulted in placing the management of the program at JSC, one of three centers participating in the program; however, because Johnson does not have control of the other centers' resources, the NSTS Program Manager's authority to manage the program is limited and the responsibility is unclear.

*Recommendation*

NASA should restructure the Shuttle Program management to define clear lines of authority and responsibilities. This restructuring should take into account the special role each center must play and be especially sensitive to the need for the cooperation and support of all the participants to achieve a common goal. NASA should give special consideration to moving the Program Manager to NASA Headquarters to avoid the confusion and inter-center rivalry that result from having a large multi-center program managed out of one of the participating centers.

*Issue 2*

Are astronauts adequately represented in management?

*Finding*

The Committee finds no evidence that astronauts are denied the opportunity to enter management if they so choose.

*b. Communication**Issue 1*

Are there adequate opportunities to communicate problems within the Shuttle Program management structure?

*Finding*

There are many regularly scheduled meetings and telecons at all levels of management throughout the Shuttle Program. In addition, "special" meetings and telecons are routine. No evidence was found to support a conclusion that the system inhibited communication or that it was difficult to surface problems.

*Issue 2*

Is too much information being disseminated so that important information is lost?

*Finding*

Large amounts of information are disseminated on a routine basis, often with little or no indication of its importance to all of the recipients.

*Recommendation*

NASA management should review the process of providing information on significant actions so that awareness by concerned managers is assured.

*Issue 3*

Are communications filtered so that important information is prevented from reaching the decision makers?

*Finding*

NASA managers delegated the responsibility for making technical judgments to lower level managers or assistants. Therefore, the information that reached the top decision makers was "filtered" in that it was interpreted by others that were presumed to have more specialized experience or expertise in a given area. There is no evidence that middle level managers suppressed information that they themselves deemed to be significant. In fact, as discussed in the section on technical expertise, the failure was not the problem of technical communications, but rather a failure of technical decision making.

*c. Safety, Reliability and Quality Assurance**Issue 1*

Is NASA's decision to establish a new Office of Safety, Reliability and Quality Assurance appropriate and, if so, what should its role be?

*Finding*

The Committee finds that the Rogers Commission recommendation that NASA should establish an Office of Safety, Reliability and Quality Assurance that reports directly to the Administrator is indeed appropriate. However, it is not clear what the activities of this office will encompass.

*Recommendations*

1. The Associate Administrator for Safety, Reliability and Quality Assurance (SR&QA) should provide to the Committee the agency's draft plan delineating the organization, goals, implementation strategies and resource requirements of the Office of SR&QA.
2. After the Office of SR&QA is fully operational, the Committee will wish to continue oversight over its activities.

*Issue 2*

Has NASA applied sufficient resources to support adequate SR&QA efforts within the NSTS program?

*Findings*

1. The Committee finds that reductions in NASA civil service personnel that have occurred over the past decade have adversely impacted the agency's ability to maintain the appropriate level of oversight and control of the SR&QA activities within the NSTS.

2. NASA has become increasingly dependent upon outside SR&QA support from the Department of Defense (Defense Contract Administration Services (DCAS) and Air Force Plant Representative Office [AFPRO]) and contractors.

3. NASA has reduced or reassigned to other program areas in-house safety, reliability and quality assurance tasks such as testing, analyses and instrumentation and has reduced or shut down in-house facilities for performing SR&QA research and technology development. The degree to which these factors have adversely impacted the safety, reliability and quality assurance activities within the NSTS program has not been adequately assessed.

*Recommendations*

1. NASA should establish and maintain a strong and effective SR&QA program. Continuing support for such a program must come directly from the Administrator.

2. Although it is appropriate to establish strong contractor capabilities in the areas of SR&QA, the internal oversight responsibilities and coordination of SR&QA tasks must be the responsibility of NASA itself. In order to assure that the appropriate interfaces among the various subsystem elements that comprise the NSTS are maintained, a sufficient complement of NASA SR&QA management and support staff must be available to perform the necessary oversight and coordination tasks.

*Issue 3*

Are the responsibilities of safety engineers and design engineers adequately specified within NASA's "risk management" program?

*Finding*

The roles of safety, design as well as reliability engineers are not adequately and uniformly defined throughout the NSTS program. In some cases, the Committee learned that safety engineers were not participating in major decisions related to flights of the Shuttle.

*Recommendation*

It should be the responsibility of the new Associate Administrator for SR&QA to fully specify the roles of safety and reliability engineering as well as quality assurance personnel within the NSTS program, so that all critical aspects of the program and decisions related to the adequacy of hardware and subsystem performance are fully reviewed by these disciplines.

*Issue 4*

Does the SR&QA program require improved coordination between centers, contractors and NASA Headquarters?

*Findings*

1. Although guidelines have been published that describe the responsibility of contractors in the areas of SR&QA, NASA's guidelines do not adequately distinguish these various activities as distinct disciplines requiring specialized skills and centralized coordination.

2. In its review of the agency's reliability and quality assurance programs as they relate to the Space Shuttle, the Committee found there was little commonality among the cognizant officials at MSFC, JSC, KSC, and Headquarters in the perception of the various responsibilities associated with these separate and distinct disciplines.

*Recommendations*

1. It is important that a clear delineation of responsibilities for the separate SR&QA disciplines be appropriately documented. It is also essential that the relative importance of each of the three separate disciplines be established as an integral part of the NSTS program. These functions are the responsibility of NASA Headquarters.

2. NASA must carefully review the staff and resources devoted to the SR&QA function within NASA and contractor organizations for adequacy. The Administrator shall report to the Committee with his findings and recommendations.

*d. Contractor Incentives**Issue*

Key Shuttle contracts (e.g., Solid Rocket Booster Production Contract and the Shuttle Processing Contract (SPC)) provide incentives both for reliability, integrity, and safety of products and services on the one hand, and for cost and schedule on the other. Do these contracts provide an appropriate balance between the two types of incentives? That is, does NASA utilize contracts to reward and promote operational safety?

*Findings*

1. The SPC provides far greater incentives to the contractor for minimizing costs and meeting schedules than for features related to safety and performance. SPC is a cost-plus, incentive/award fee contract. The amount of the incentive fee is based on contract costs (lower costs yields a larger incentive fee) and on safe and successful launch and recovery of the Orbiter. The award fee is designed to permit NASA to focus on those areas of concern which are not sensitive to the incentive fee provisions, including the safety record of the contractor. However, the incentive fee dwarfs the award fee—while the maximum value of the award fee is only one percent of the value of the SPC, the incentive fee could total as much as 14 percent of the SPC.



2. During the developmental phases of the Thiokol contract for Solid Rocket Booster production (1980-1983), the contractor received consistent ratings of "Excellent-Plus" or "Superior" under the cost-plus, award-fee contract. NASA contracted with Thiokol on a cost-plus, incentive-fee (CPIF) basis beginning in July 1983. The CPIF contract pays strictly on the basis of costs, although penalties may be invoked for delays in delivery or for Shuttle accidents due to SRB failure. At the time of the Challenger accident, Thiokol was eligible to receive a very large incentive fee, probably on the order of \$75 million.

### *Recommendations*

1. NASA should reexamine all Shuttle contracts and report to the Committee with its findings and recommendations on whether more incentives for safety and quality can be built into these contracts. This report should address, *inter alia*, the SRB Production Contract and the SPC.

2. NASA's new Office of SR&QA should be involved in the procurement and award fee processes, both to establish reasonable guidelines and rewards in new contracts and to judge performance of ongoing contracts.



## IV. BACKGROUND

### INITIAL EVENTS FOLLOWING THE ACCIDENT

On January 28, Chairman Fuqua stated on the floor of the House that the Committee would conduct comprehensive hearings and prepare its report on the Challenger accident and its implications after the National Aeronautics and Space Administration had completed its immediate investigation. NASA's effort was to follow the same investigative approach it had taken after the Apollo 204<sup>1</sup> fire.

In preparation for this time, Mr. Fuqua working with Mr. Lujan, the Ranking Republican Member, appointed a steering group of Committee Members two days following the accident to guide the Committee's work. This group consisted of:

Don Fuqua

Harold Volkmer

Bill Nelson

Manuel Lujan, Jr.

Robert Walker

Ron Packard

However, this plan and timetable were changed when President Reagan, by Executive Order, established a Presidential Commission on the Space Shuttle Challenger Accident on February 3, 1986. The order directed the Rogers Commission to make its final report to the President and the Administrator of NASA within 120 days. The order directed the Commission to: "(1) Review the circumstances surrounding the accident to establish the probable cause or causes of the accident; and (2) Develop recommendations for corrective or other action based upon the Commission's findings and determinations."

With this important new development, the Committee Steering Group met and decided to modify its earlier approach of investigating NASA's inquiry to that of reviewing the Rogers Commission's investigation. It was determined that the Committee's formal work would begin as soon as practicable after the Rogers Commission issued its report.

### COMMITTEE PREPARATION

On February 5, the Chairman, Mr. Fuqua, and Mr. Lujan, wrote a letter to Chairman William P. Rogers stating their support for the serious task which was ahead of the Presidential Commission. In that letter Messrs. Fuqua and Lujan also outlined the Committee's approach, saying:

We would like to begin our oversight process by asking you to establish procedures for providing us with progress reports as appropriate so that we can be kept advised of

---

<sup>1</sup> On January 27, 1967, astronauts Virgil Grissom, Edward White II and Roger Chafee were killed when their Apollo spacecraft was destroyed by fire on the launch pad.

the activities of your Commission. At the conclusion of the Commission's work, we will undertake a thorough review of your report; we expect that this review will be similar to the review and hearings held after the Apollo 204 fire and the Apollo 13 incident.<sup>2</sup>

It is our understanding that the Commission is tasked with completing its report in 120 days. In light of this fact, we would like to request your appearance before the Science and Technology Committee during the first week in June, or within one week of your final report, should you complete it sooner.

The letter to Chairman Rogers also noted that a similar letter had been sent that same day to the NASA Acting Administrator, Dr. William R. Graham. It stated that the Committee also planned, after hearing from the Commission, to take testimony from NASA management on the accident, and "closely review NASA proposed management plans designed to implement the Commission's recommendations."

Chairman Fuqua and Chairman Rogers then worked out an informal arrangement for the Committee Steering Group so that when there was sufficient reason to meet, in the opinion of the two chairmen, Chairman Rogers would brief the Steering Group on the progress of the investigation.

By April 22, the Steering Group felt it had heard sufficient information to brief the Members of the full Committee on Science and Technology. This was done in a closed meeting that day.

On May 16, 1986, Chairman Fuqua sent a memorandum to all Members stating that he had asked Congressman Robert Roe, the Ranking Majority Member, to chair the Committee hearings on the Challenger accident, stating that "there is a distinct possibility that follow-through activities related to the hearings will carry over into the next Congress in which I shall not serve."

#### COMMITTEE TRIP

When it appeared that the Rogers Commission would be able to meet its 120-day deadline, Mr. Roe arranged to take a group of Committee Members and key staff to the Kennedy Space Center on June 6, 1986. At the Center the Members heard detailed accident briefings, took a tour of the Vehicle Assembly Building where a set of Solid Rocket Motors and External Tank was examined, and viewed the recovered debris from the Challenger spacecraft.

#### THE HEARINGS

The Rogers Commission report was released on June 9, 1986. Immediately thereafter, the full Committee began its inquiry under the direction of Mr. Roe. The Committee heard from 60 witnesses during 10 days of hearings, for a total of 41 hours. A compilation follows:

---

<sup>2</sup> On April 13, 1971, Apollo 13's Command and Service Modules were disabled by an oxygen tank explosion en route to the Moon. The crew was recovered safely.

## CHALLENGER INVESTIGATION HEARINGS

[Witnesses and total days of hearings]

Days of hearings	Total witnesses	Witnesses
June 10, 1986.....	3.....	Hon. William P. Rogers, Chairman, Presidential Commission on the Space Shuttle Challenger Accident. Neil Armstrong, Vice Chairman. Dr. Alton Keel, Executive Director.
June 11, 1986.....	7.....	Dr. James C. Fletcher, Administrator, NASA. RADM Richard Truly, Associate Administrator for Space Flight, NASA, accompanied by Mr. Edward Aldridge, Secretary of the Air Force, Washington, DC. Arnold D. Aldrich, Manager, National Space Transportation System, NASA. Dr. William Graham, Deputy Administrator, NASA. Dr. Dan Germany, Leader, Photo and TV Analysis Team, NASA. Capt. Robert L. Crippen, Astronaut, NASA.
June 12, 1986.....	12.....	Dr. James C. Fletcher, Administrator, NASA. Arnold D. Aldrich, Manager, National Space Transportation System, NASA. Mr. L. Michael Weeks, Deputy Associate Administrator (Technical), Office of Space Flight, NASA. Dr. Milton A. Silvera, Chief Engineer, NASA. RADM Richard Truly, Associate Administrator for Space Flight, NASA. J.R. Thompson, Vice Chairman, NASA, STS 51-L Design and Data Analysis Task Force, NASA. Dr. William Graham, Deputy Administrator, NASA
REPRESENTATIVES FROM NASA'S TASK TEAMS		
June 17, 1986.....	10.....	Dan Germany, Deputy Manager, Space Station Project Office, NASA, Johnson Space Center. John Thomas, Manager Ad Hoc, Solid Rocket Motor Design Team, Marshall Space Flight Center. Thomas J. "Jack" Lee, Deputy Director, Marshall Space Flight Center. Thomas Holloway, Chief, Flight Director Office, NASA, Johnson Space Flight Center. Thomas Utsman, Deputy Director, NASA, Kennedy Space Center. Charles S. Locke, Chairman of the Board and Chief Executive Officer, Morton Thiokol. Joseph C. Kilminster, Vice President, Space Operations, Morton Thiokol. Allan J. McDonald, Director, SRM Verification Task Force, Morton Thiokol. Roger M. Boisjoly, Staff Engineer, Morton Thiokol. U. Edwin Garrison, President, Aerospace Group, Morton Thiokol. Carver G. Kennedy, Vice President, Space Booster Programs, Morton Thiokol. Arnold R. Thompson, Supervisor, Structures Design, Morton Thiokol. Dr. William Graham, Deputy Administrator, NASA, accompanied by Thomas Moser, Deputy Administrator, Office of Space Flight, NASA. RADM Richard Truly, Associate Administrator for Space Flight, NASA. Dr. William Lucas, Director, Marshall Space Flight Center, accompanied by J. Wayne Littles, Deputy Director of Science and Engineering, Marshall Space Flight Center. Lawrence Mulloy, Assistant to the Director for Science and Engineering, Marshall Space Flight Center. Gerald W. Smith, Manager, Solid Rocket Booster Project, Marshall Space Flight Center. Stanley Reinartz (no comment), Manager, Special Projects Office, Marshall Space Flight Center. William Sneed, Assistant Director, Policy and Review, Marshall Space Flight Center.
June 18, 1986 <sup>1</sup> .....	5.....	U. Edwin Garrison, President, Aerospace Group, Morton Thiokol. Joseph C. Kilminster, Vice President, Morton Thiokol. Carver G. Kennedy, Vice President, Space Booster Program, Morton Thiokol. Allan J. McDonald, Director, SRM Verification Task Force, Morton Thiokol. Roger M. Boisjoly Staff Engineer, Morton Thiokol.
June 25, 1986.....	6.....	Arnold R. Thompson, Supervisor, Structures Design, Morton Thiokol. Maj. Donald "Deke" K. Slayton, Brig. Gen. James A. McDivitt, Capt. John W. Young, Col. Henry W. Hartsfield, Jr., Comdr. Robert L. Gibson, Gen. Thomas Stafford.
July 15, 1986.....	3.....	George Jeffs, President, North American Space Operations, Rockwell International. Richard M. Davis, President, Martin Marietta Michoud Aerospace. George Murphy, Executive Vice President and General Manager, United Technology Booster Production Co.
July 16, 1986.....	7.....	E.D. Sargent, President, Lockheed Space Operations Co. and Program Manager, Shuttle Processing Contract, accompanied by Fred Haise, President, Grumman Technical Services Division. Carver Kennedy, Vice President, Space Booster Programs, Morton Thiokol. David Owen, Lockheed Space Operations Co. and Deputy Program Manager, Kennedy Space Center.

## CHALLENGER INVESTIGATION HEARINGS—Continued

[Witnesses and total days of hearings]

Days of hearings	Total witnesses	Witnesses
July 23, 1986.....	2.....	Charlie Floyd, Systems Engineer, Lockheed Space Operations Co. James R. Dubay, President and General Manager, EG&G Florida, Inc., accompanied by Dr. Donald Kerr, Senior Vice President, EG&G Florida, Inc.
July 23, 1986.....	2.....	George R. Faenza, Vice President and General Manager, McDonnell Douglas Astronautics Co. Alan M. Lovelace, Vice President and General Manager, Space Systems Division, General Dynamics Corp.
July 24, 1986.....	5.....	John F. Yardley, President, McDonnell Douglas Astronautics Co. Lt. Gen. James A. Abrahamson, Director, Strategic Defense Initiative, Department of Defense. Jesse W. Moore, Director, Johnson Space Center, NASA/Houston, Texas. Robert F. Thompson, Vice President, Space Stations, McDonnell Douglas Astronautics Co. G.S. Lunny, President, Satellite Systems Division, Rockwell International. Arnold Aldrich, Manager, National Space Transportation System, Lyndon B. Johnson Space Center, NASA/Houston, Texas.
Total.....	60.....	

<sup>1</sup> Continued from June 17, Morton Thiokol only.

## V. THE ACCIDENT

### A. INTRODUCTION

This section as well as Sections VII and VIII identify what happened, as well as what did not happen, to cause the loss of the Challenger. This section also discusses why the accident happened in an effort to prevent future catastrophes.

By the time the Rogers Commission had completed its report, it had been learned that many items investigated by the Commission did not contribute to the accident. Consequently, this section is directed toward a more narrow range of possible contributing causes.

There were human as well as technical failings that combined on the morning of January 28, 1986, to cause the Challenger accident. Most of NASA's personnel were not involved in the Solid Rocket Motor program while there were others outside of NASA, such as the media, the Congress and the Administration, who were involved through their influence on the Shuttle program.

It should also be recognized that this report has the advantage of hindsight. Our investigation indicates that the decision to launch Challenger on January 28 suffered equally from a lack of information, misinterpretation of the information that was available, and a complex interplay of personalities among the principals involved. We are equally convinced, however, that the resulting decision to launch was arrived at as a logical conclusion of faulty premises, coupled with a failure to recognize the effect of temperature on the design.

We hope the lessons learned from this accident will lead to design improvements in the Shuttle Program. Just a few years ago, the collapse of the Hartford Civic Center contributed to the improvement of engineering design techniques to accommodate the unique secondary forces inherent in long-span structures. The Gothic cathedrals of the fourteenth century were constantly improved after their early failures were studied.

We hope this section, as well as Sections VII and VIII, properly identify the mistakes that led to the Challenger accident. It is the intent of the Committee to identify these mistakes so that NASA will regain its former level of excellence. The Committee has confidence that the men and women of the National Aeronautics and Space Administration will meet the challenge, improve the Shuttle and their management methods, and go on to explore new frontiers in space. This assumes, however, that the agency will now receive resources adequate to support the programs it is authorized to carry out by the Congress and the President.

For the benefit of those who may not be familiar with the Space Transportation System, the Shuttle consists of an Orbiter (51-L's Orbiter, the Challenger, was one of a four-vehicle fleet), an External Tank (ET), and two Solid Rocket Boosters (SRBs). (See Figure V-1.) A brief description of the Solid Rocket Booster and the Solid Rocket Motors is included to familiarize readers with these systems.



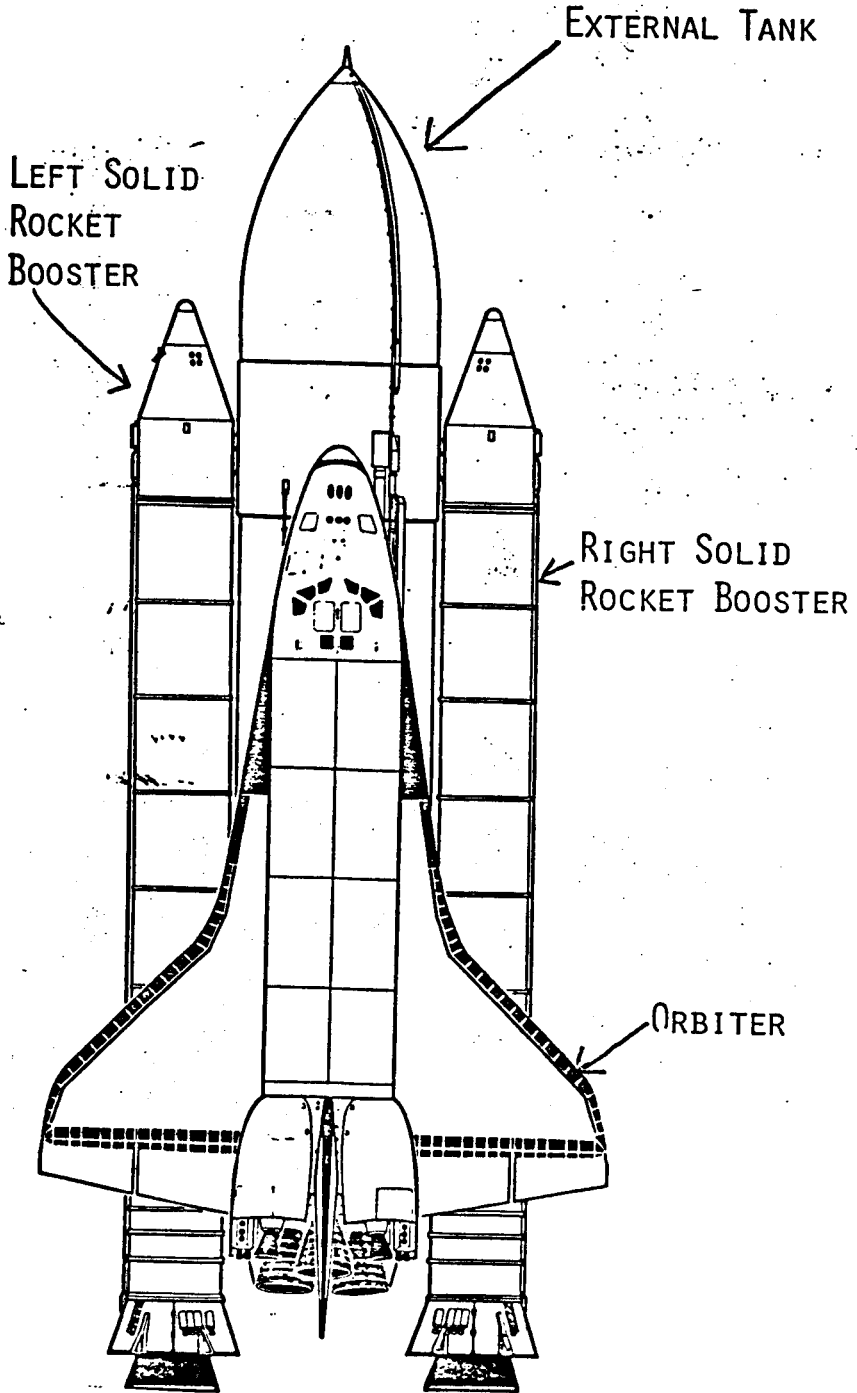

FIGURE V-1

The Solid Rocket Boosters operate in parallel with the main engines for the first two minutes of flight to provide the additional thrust needed if the Orbiter is to escape the gravitational pull of the Earth. At an altitude of approximately 144,000 feet (24 nautical miles), the SRBs separate from the Orbiter/External Tank, descend on parachutes, and land in the Atlantic Ocean. They are recovered by ships, returned to land, and refurbished for reuse.

The heart of the booster is the Solid Rocket Motor (Figure V-2). It is the largest solid propellant motor ever developed for space flight and the first built to be used on a manned craft. Larger solid motors have been test-fired but have never been carried through complete development to actual use in flight. The huge Solid Rocket Motor is composed of a segmented motor case loaded with solid propellant, an ignition system, a movable nozzle, and the necessary instrumentation and integration hardware.

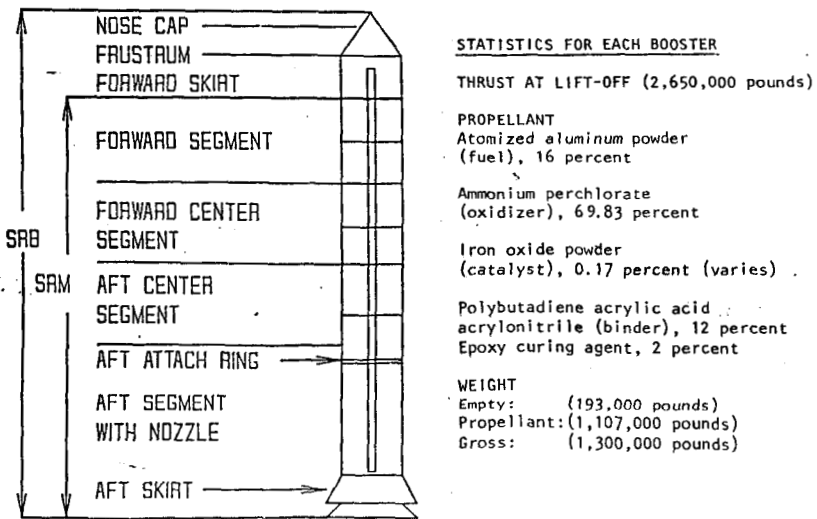

FIGURE V-2

Each motor case is made of 11 individual weld-free steel segments (Figure V-3). Averaging approximately 1.27 centimeters (0.5 inch) thick, the steel is a high-strength formulation. Each segment is heat-treated, hardened, and machined to the exact dimensions required. The 11 segments are held together by 177 high-strength steel pins at each case segment joint. The clevis-type joints are wrapped with reinforced fiberglass tape and sealed with a rubber seal band that is bonded to the case with adhesives.

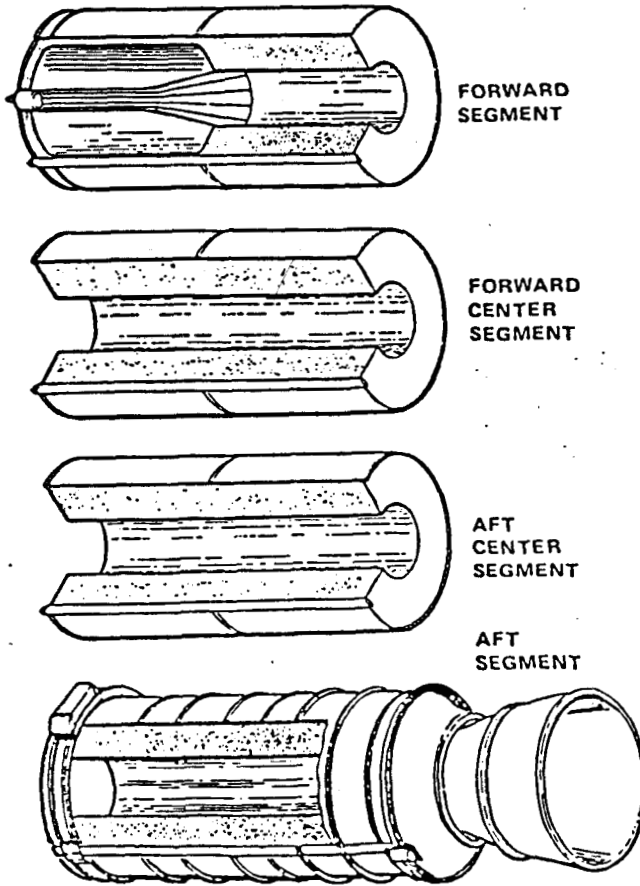

FIGURE V-3

In this report there are many references to the joint design, erosion and O-ring seals. There are several different joint designs used in the Solid Rocket Motor. The joint that failed on the last Challenger flight, the aft field joint, was not the one that had been giving NASA the most trouble. More O-ring erosion had been experienced on nozzle joints, the design of which is significantly different than the aft field joint. However, since NASA treated erosion as a problem that impacted both the nozzle and field joints, the data on erosion in this section includes that obtained from the nozzle joint.

Whenever a temperature is specified, it is essential that it be related to a specific medium such as air (or ambient temperature), rocket propellant, or casing joints, for example. The temperature of the joints, air and propellant can all be different at the same time,

just as the ocean temperature at the beach on a 90-degree day could be 75 degrees.

Much of this discussion concerns heat, or the absence thereof. For example, if an O-ring had given up heat during the night, it would very likely be at a lower temperature than the temperature of the air in the morning after the sun had risen. This was the situation at the time Flight 51-L was launched. The heat gained by the joint in the time after sunrise was not sufficient to raise the temperature of the O-ring material to a level where Thiokol engineers believed the O-ring could respond and seal the joint under ignition pressures.

The following chart describes the principal steps in the evolution, flight, and reconditioning of the Solid Rocket Motors (Figure V-4).

SOLID ROCKET MOTOR

PRINCIPAL STEPS IN THE EVOLUTION, FLIGHT AND RECONDITIONING OF SOLID ROCKET MOTORS

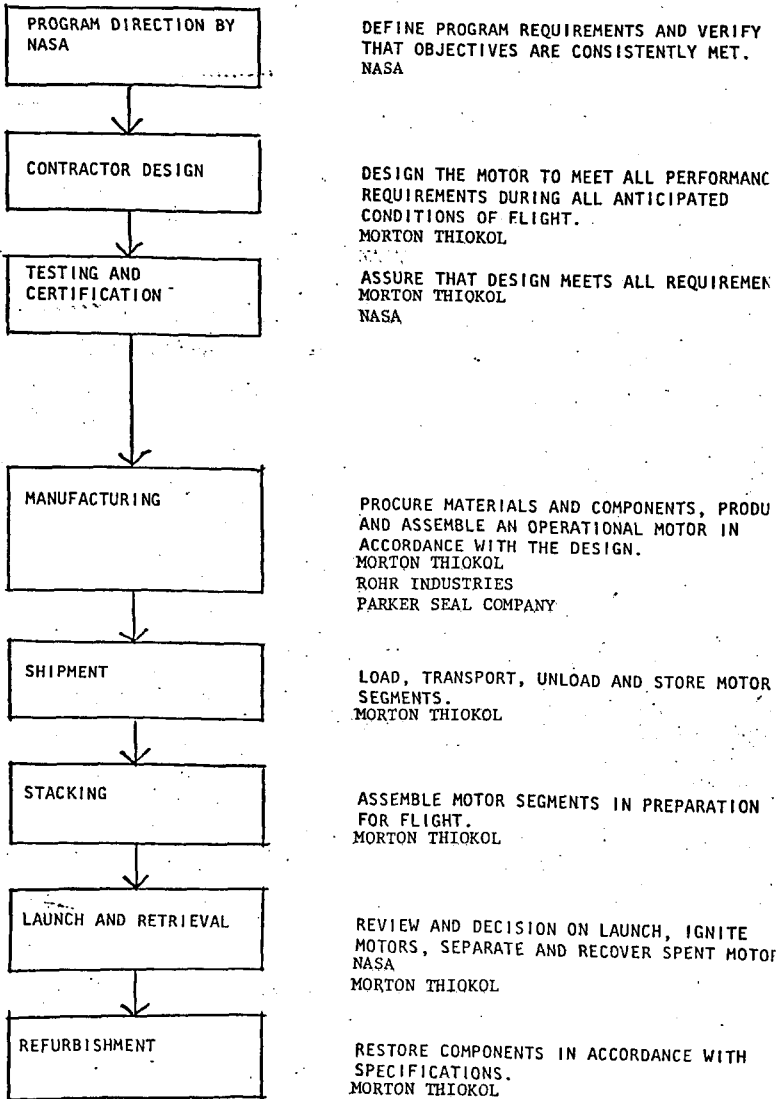

FIGURE V-4

FIGURE V-4

Because of the difficulty the reader may find in understanding the NASA Flight Readiness Review for the Solid Rocket Booster for Flight 51-L and the terms used to describe the steps in the process, the following chart describes the level of review, office conducting the review, and the scope of the review. In addition to the following meeting chart, there were numerous other ad hoc meetings on the SRMs including the meeting between NASA and Thiokol personnel during the evening before the launch of Flight 51-L.

TABLE I.—FLIGHT READINESS REVIEWS

(STS-51L)

Level and date	Reviewing office	Scope of review
IV—Dec. 11, 1985.....	Thiokol Wasatch.....	Conducted by Thiokol Solid Rocket Motor program managers in preparation for presentations to Marshall Space Flight Center (MSFC).
III—Dec. 17, 1985.....	SRM Office.....	Conducted by Larry Wear, Manager of the Solid Rocket Motor Program Office, MSFC. Material presented by Thiokol personnel.
III—Jan. 3, 1986.....	SRB Project Office.....	Conducted by Larry Mulloy, Manager of the Solid Rocket Booster Project Office. This is a combined briefing on the SRM and the elements making up the booster assembly, which, when integrated make up the Shuttle Solid Rocket Boosters.
III—Jan. 9, 1986.....	Shuttle Projects.....	Conducted by Stanley Reinartz, Manager, Space Shuttle Projects Office, MSFC. This review discusses all elements of the Shuttle managed by Marshall.
III—Jan. 13, 1986.....	Center Board.....	Conducted by Dr. William Lucas, MSFC Director. Final discussion of Marshall hardware in preparation for review by the Space Transportation System Program Manager.
II—Jan. 14, 1986.....	STS Program.....	Conducted by Arnold Aldrich, Space Transportation System Program Manager. First review dealing with the flight vehicle and associated ground support in its entirety.
I—Jan 15, 1986.....	Space Flight.....	Conducted by Jesse Moore, Associated Administrator for Space Flight. Remaining items that impact launch are discussed and assigned for disposition. Certificate of Flight Readiness is signed.
I—Jan. 25, 1986.....	L-1 Review.....	Meeting of the Mission Management Team to receive reports on action items remaining from the Flight Readiness Review. All action items should be closed by this time.

Considerable reference will be made to the "joint design" throughout this section of the report. Consequently, the following description of the joint is provided. (See Figures V-5 thru V-7.)

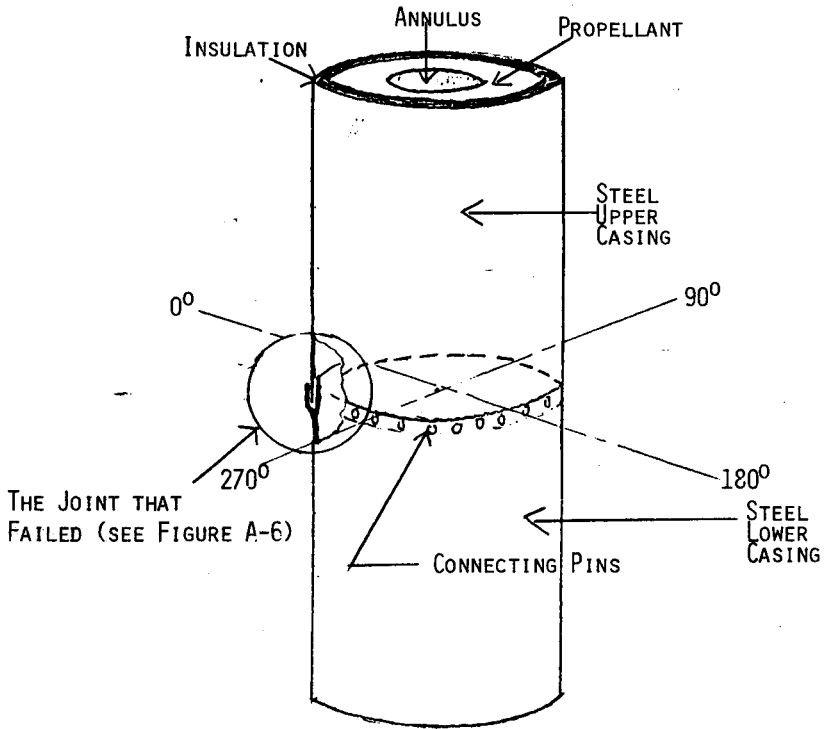
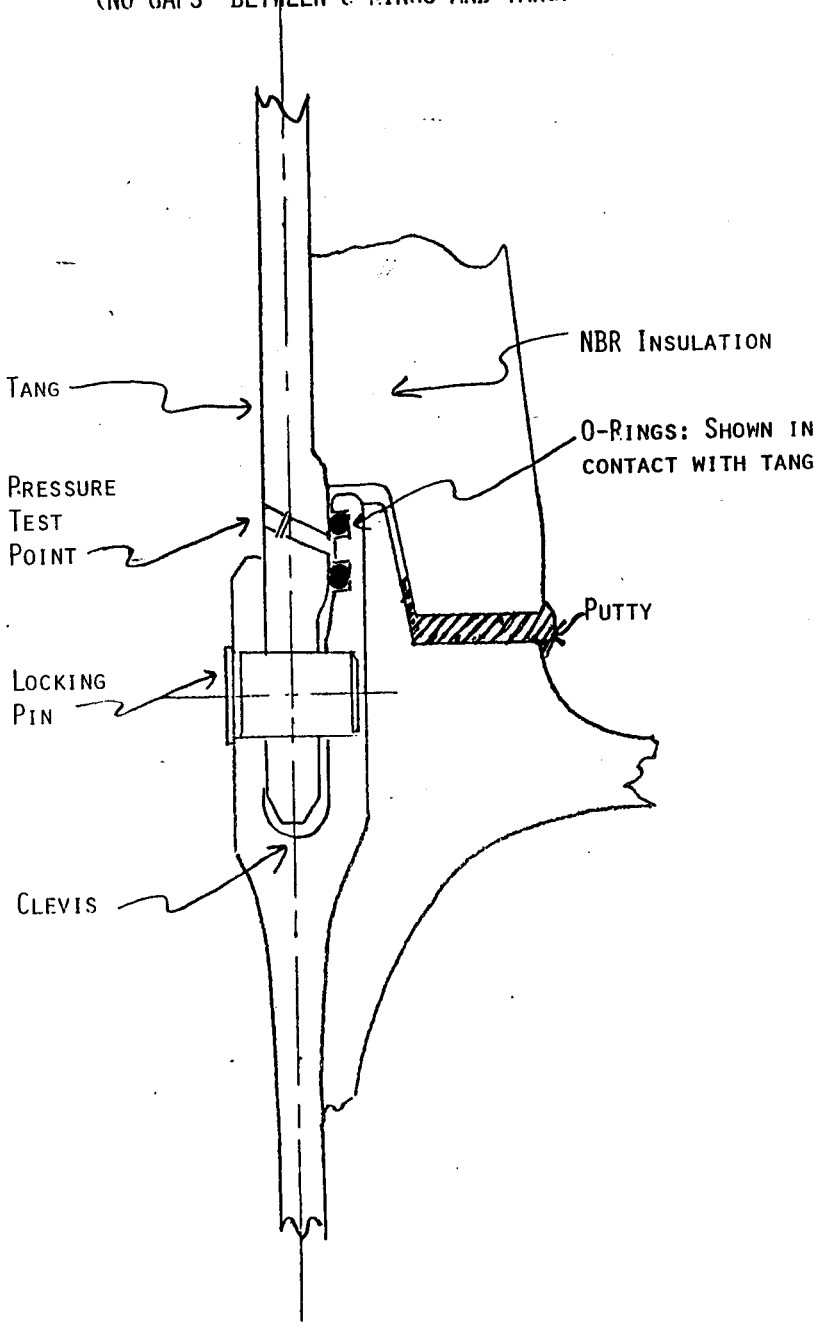

FIGURE V-5

A. JOINT IN NORMAL ALIGNMENT  
(NO GAPS BETWEEN O-RINGS AND TANG)





B. JOINT ROTATED  
(OUT OF ALIGNMENT)

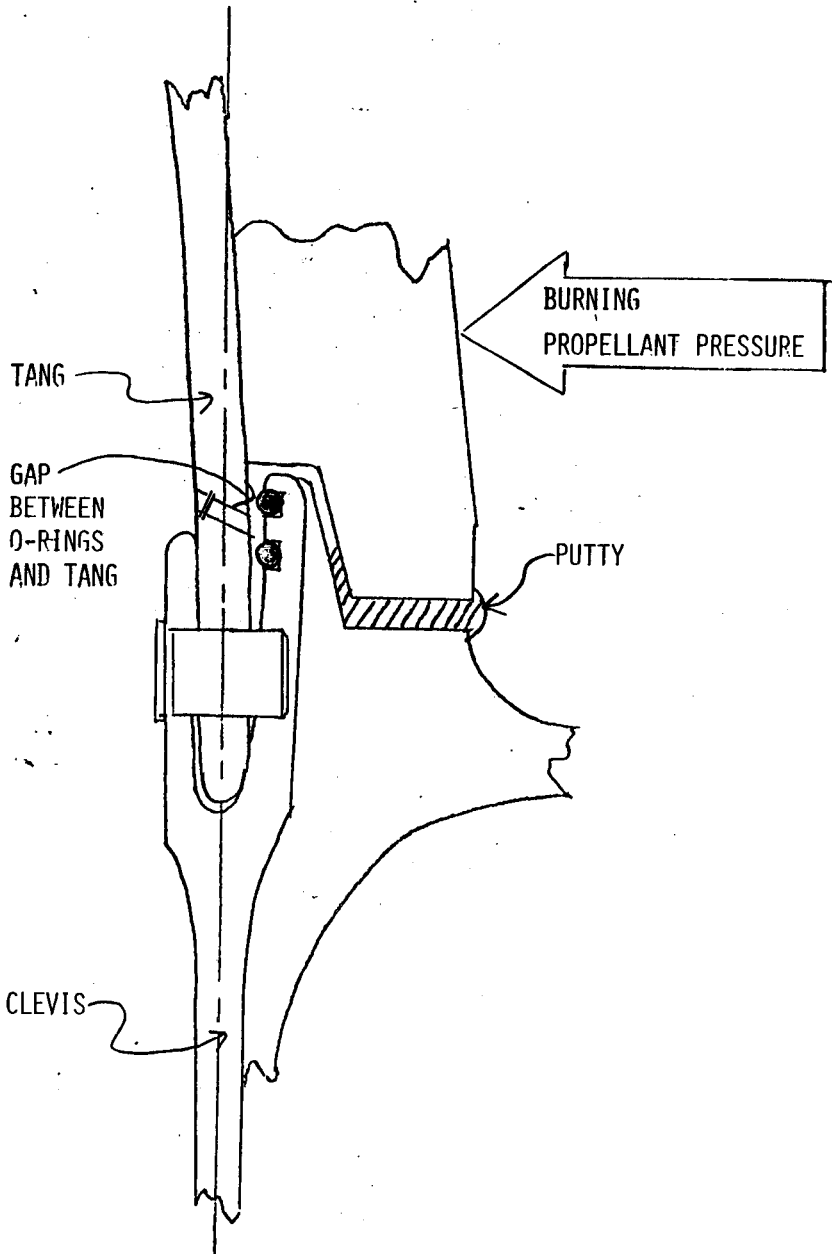

FIGURE V-7

## B. SOLID ROCKET MOTORS

### 1. HISTORY

#### *Issue*

Was there sufficient time to correct the problems with the Solid Rocket Motor?

#### *Findings*

1. Problems with the joints which connect the Solid Rocket Motor casings were recognized for many years. While attempts were made to correct these problems, the measures taken were insufficient to provide a reliable joint.

2. The joint seal problem was recognized by engineers in both NASA and Morton Thiokol in sufficient time to have been corrected by redesigning and manufacturing new joints before the accident on January 28, 1986. Meeting flight schedules and cutting cost were given a higher priority than flight safety.

#### *Discussion*

At seven different times in the Shuttle Program, NASA and Thiokol managers made poor technical decisions that ultimately permitted continued flight of an unsafe Solid Rocket Motor design.

1. NASA's issuing of a performance specification that did not adequately take into account the known weather conditions that occur in Florida during the winter months.

2. Accepting the new joint design without sufficient certification and testing.

3. Failure to accept John Miller's <sup>1</sup> recommendations to redesign the clevis joint on all on-coming hardware at the earliest date.

4. Establishing a specific value for the upper limit of erosion that could be tolerated in flight on the basis of a "computer program model" instead of recognizing the erosion itself as a failure of the joint.

5. Proceeding through more than four years of Shuttle flights with continuing joint/seal problems without designing, testing and incorporating a new type of field joint and nozzle joint as well.

6. NASA's permitting Thiokol to continue making Solid Rocket Motors without conducting full scale tests as had been requested by NASA 14 months previously.

7. Mr. Mulloy's description of joint failures as being within "their experience base." In other words, if it broke before and the size of the recent break was no bigger than those before, then there was no problem. Even when the erosion surpassed all previous experience, NASA then went on and expanded its "experience base."

What follows is a list of events and documents which relate to the cause of the accident. They are included here to demonstrate that there was adequate experience and information available before the accident and that this information should have been sufficient to cause the initiation of corrective action before the launch of Flight 51-L.

---

<sup>1</sup> John Q. Miller is Chief, Solid Motor Branch, Marshall Space Flight Center, NASA.

*July 16, 1973.*—NASA issues a Request for Proposal (RFP) for the Space Shuttle Solid Rocket Motor project. Under "Scope of Proposal," the RFP stated in part:

NASA considers that a prime contractor's use of established expertise in the private sector is an essential approach toward the objective of maximum economic effectiveness. Proposals from joint ventures will not be accepted, and the development of new expertise by a prime contractor, either in-house or elsewhere in the private sector, is to be avoided to the extent possible, since the latter course detracts from the stated objective.

This RFP is specifically directed toward the design, development, test, production, acceptance, operation, and refurbishment of the Solid Rocket Motor and its ancillary equipment, post-flight analysis, and support functions. It is imperative in all considerations of the proposal and its subsequent implementation, that effort be made to minimize production and operating costs while maintaining reasonable DDT&E costs. The minimization of these costs entails the utilization of design and production approaches that will result in the lowest possible cost per flight consistent with the Space Shuttle Program early year funding constraints and the design, performance and reliability requirements.<sup>1a</sup>

*August 27, 1973.*—Thiokol, in the Executive Summary to its response to the RFP, addressed NASA concerns regarding SRM reliability (Appendix N, RFP 8-1-4-94-98401). Among other failure modes identified by NASA, Thiokol described the steps it had taken to prevent O-ring seal failure. These included:

#### DESIGN FEATURES

Redundant seals;  
Protection of mating surfaces;  
Assure proper environment and capability.

#### TEST AND CONTROL FEATURES

Functional leak check of dual seals prior to test or use;  
Material migration/compatibility tests to demonstrate suitability.<sup>1b</sup>

*November 19, 1973.*—In its report to NASA Administrator James C. Fletcher, the Solid Rocket Motor Source Evaluation Board (SEB) evaluated the proposals generated by the Solid Rocket Motor RFP. Thiokol scored 124 out of a possible 200 points for its motor design, the lowest score among the four competitors. The only design strength identified by the Board: "Case joint leakcheck capability increases reliability and improves checkout operations."<sup>1c</sup>

<sup>a</sup> NASA, Marshall Space Flight Center, "Request for Proposal: Space Shuttle Program Solid Rocket Motor Project," RFP 8-1-4-94-98401, Volume 1, July 16, 1973, pp. 1-3, 1-4.

<sup>b</sup> Thiokol, "Executive Summary: Proposal for Solid Rocket Motor Project for the Space Shuttle Program," Publications No. 0873-73270-1, Volume 1, August 27, 1973, p. 3-10 (Table 3-4).

<sup>c</sup> NASA, Marshall Space Shuttle Center, "Presentation to NASA Administrator: Solid Rocket Motor Project Source Evaluation Board," RFP 8-1-4-94-98401, November 19, 1973, Chart D-4.

*November 1973.*—The SEB Design, Development and Verification Team Report rejected proposals by Aerojet and United Technologies Corporation to test motor performance at 40° and 90° Fahrenheit. The report stated that “The temperature conditioning of two motors to verify the motor performance over the range of 40° to 90° is not required, as this data can be obtained from the normal variation in ambient conditions.”<sup>1d</sup>

*December 12, 1973.*—NASA Administrator James C. Fletcher announced selection of Morton Thiokol as contractor for Design, Development, Test and Evaluation (DDT&E) of the Solid Rocket Motors. In the source selection statement, “Selection of Contractor for Space Shuttle Program, Solid Rocket Motors,” a statement was included that indicates that Thiokol ranked fourth out of the four bidders in the design category (See Appendix V-A). NASA, however, placed greater importance on cost reduction and Thiokol had an attractive cost proposal.<sup>2</sup>

*January 9, 1978.*—Major problems with the joint design were identified when Mr. John Miller of NASA sent a memo to Mr. Eudy. In it Miller stated, “Calculations performed by MSFC [Marshall Space Flight Center personnel] and agreed to by Thiokol show that distortion of the clevis joint tang for any joint can be sufficient to cause O-ring/tang separation. Data from DMT-1 [Development Motor Test-1] showed that this condition could be created by joint movement . . .” Miller continued, “All situations which could create tang distortion are not known, nor is the magnitude of movement known.” Miller also noted that 15 percent industry recommended a compression value of 15 percent for adequate O-ring performance. He also cited a Thiokol test report dated August 15, 1977, TWR-11507, which showed a maximum compression of 5.8 to 7.0 percent for O-ring material and spliced joints. Finally, Miller also recommended a redesign of clevis joints on all on-coming hardware at the earliest possible effectivity to preclude unacceptable, high risk, O-ring compression values.

*November 7, 1978.*—Ten months later it would appear that there was nothing to worry about when a letter from E. G. Dorsey of Thiokol to Mr. George Hardy of MSFC contained the statement, “The extrusion data presented in the review and mentioned in the minutes have confirmed the capability of the O-rings to prevent leakage under the worst hardware conditions.” Mr. Dorsey attached the Thiokol TWR-12019, dated October 6, 1978 to his letter.

*February 2, 1979.*—Mr. Eudy and Mr. Ray of NASA visited the Parker Seal Company. A trip report was sent to Messrs. Hardy/Rice/McCool of NASA which contained the following statement: “Parker experts would make no official statements concerning reliability and potential risk factors associated with the present design however, their first thought was that the O-ring was being asked to perform beyond its intended design and that a different type of seal should be considered. The need for additional testing of the present design was also discussed and it was agreed that tests which more

<sup>1d</sup> NASA, Marshall Space Flight Center, “Design, Development and Verification Team Report: Solid Rocket Motor Project,” November 1973, p. 50.

<sup>2</sup> NASA, “Selection of Contractor for Space Shuttle Program, Solid Rocket Motors,” January 2, 1974.

closely simulated actual conditions should be done." This report also referred to the O-ring extrusion gap being larger than Parker had previously experienced. (See Appendix V-I.)

*November 12, 1981.*—During STS-2, the second Shuttle flight, erosion of the primary O-ring was discovered in the 90 degree location of the aft field joint of the right hand Solid Rocket Motor. The 0.053 inch erosion was not discussed in the STS-3 Flight Readiness Reviews.<sup>3</sup> This was the deepest O-ring erosion that would be discovered in any case field joint.

*February 25, 1983.*—Employees of Thiokol discussed joint "gap size" and "O-ring compression" at a briefing at the Marshall Space Flight Center (MSFC).<sup>4</sup>

*March 17, 1983.*—Mr. Lawrence Mulloy, MSFC Solid Rocket Booster (SRB) Project Manager, informed NASA Level 1 (meaning the Associate Administrator for Space Flight), of the pending change in criticality from 1R to 1, which meant that a single seal failure could result in the loss of the Shuttle and crew. That change was approved on March 28, 1983.<sup>5</sup>

*April 4, 1983.*—STS-6 was the first flight to use the "lightweight case." It was also the first flight where a criticality factor of 1, instead of 1R, was assigned to the joint. After the flight, "blowholes" in the nozzle to case joints, not the case field joints, were found in both the left and right Solid Rocket Motors. These observations were not discussed in the Flight Readiness Reviews for STS-7.<sup>6</sup>

*December 6, 1983.*—An internal Marshall Space Flight Center (MSFC) memo from Mr. Miller to Mr. Horton highlighted the seal leak detection and zinc chromate putty problems. (See Appendix V-D.)

*February 22, 1984.*—Marshall Space Flight Center memorandum from Ben Powers to Horton requested that post-flight and post-static firing inspection on specific joints be made. The memo expressed concern about adhesion life of the zinc chromate sealant after installation on the SRM. See Appendix V-F.

*March 2, 1984.*—Thiokol personnel described the erosion discovered in the 351 degree location of the left Solid Rocket Motor forward field joint of STS-41B at a Flight Readiness Review. The erosion extended over three inches with a maximum depth of 0.040 inches. This was the first time the subject of O-ring erosion sustained on flights STS-2 and STS-6 was discussed as a technical issue at a Flight Readiness Review.<sup>7</sup>

*March 8, 1984.*—The notion of ACCEPTABLE EROSION was mentioned at a meeting of the Shuttle Projects Office Board for STS-41-C. Even though the joint was now classified as Criticality 1, which meant that failure of the joint could lead to the loss of the Shuttle and crew, the concept of "maximum possible" erosion, 0.090 inches, was accepted as an absolute value based on a comput-

<sup>3</sup> Thiokol Report, TWR-300209, Brian Russell, "Narrative History of SRM Seal Erosion and Blowby Incidents," June 25, 1986, p. 3.

<sup>4</sup> Rogers Commission Report, Volume II, p. H-1.

<sup>5</sup> *Ibid.*

<sup>6</sup> *Ibid.* [NOTE.—The nozzle to case joint design is significantly different than the case field joint design which caused the Challenger accident. However, it is cited here because some of the problems are relevant to the failure of the aft field joint.]

<sup>7</sup> *Ibid.*

er program which was supported by limited data. Furthermore, the 0.090 inch value was based on the concept that the O-ring would seal at 3 times the actual motor pressure even if the erosion extended to 0.095 inches thereby giving comfort in continuing with a known problem.<sup>8</sup>

*March 1984.*—Thiokol submitted their "Performance Characteristics of the SRM O-ring Assembly Test Plan," TWR-14336, which contained the following statement: "O-ring seals in rocket motors in general and the Space Shuttle SRMs in particular can suffer thermal degradation because of exposure to the high temperature motor chamber gases. Although none of the SRM primary O-rings to date have failed to perform their design function, there is some concern because of isolated events which show localized erosion as high as 0.053 inches. The postulated scenario for this thermal degradation effect is a short time duration impingement of a high energy jet which is induced during ignition pressurization by a combination of voids in the protective vacuum putty and the filling of available free volumes created by the tolerances of mating parts and the O-ring slots."

*March 20, 1984.*—Acceptable erosion was again discussed at the Flight Readiness Review briefing to the Marshall Center Board.<sup>9</sup>

*March 27, 1984.*—Mr. Mulloy discussed O-ring erosion at the Level 1 Flight Readiness Review for STS41-C. As a result, he received an "action item" to review the case and nozzle seals. The action did not have to be completed before the flight of STS41-C.<sup>10</sup>

Mr. Lawrence Wear, the Solid Rocket Motor (SRM) Element Manager, then directed Thiokol to establish a plan and a test program to investigate the issue. Thiokol was directed to determine if the O-ring erosion was acceptable and if so, why?<sup>11</sup>

*April 6, 1984.*—Heat degradation of the O-ring in the left SRM aft field joint of STS41-C was found, along with "blowholes" in the putty.

*April 12, 1984.*—In an internal Marshall Space Flight Center memorandum, John Q. Miller told Mr. Horton that "stacking difficulties and observed O-ring anomalies" were increasing with the use of Randolph putty. The former supplier, Fuller O'Brien, had discontinued producing the putty previously used in the Shuttle program. Accordingly, putty was ordered from Randolph Products. The memo requested expedited development of a putty with the characteristics of the Fuller O'Brien putty used prior to STS-8.

*May 4, 1984.*—Morton Thiokol prepared a Program Plan for the protection of Space Shuttle SRM primary motor seals. Thiokol's objective was to isolate the joint problem and to eliminate damage to the motor seals, the O-rings. The plan called for analysis and testing of O-rings, putty and associated lubricants.<sup>12</sup> See Appendix V-B.

<sup>8</sup> Ibid.

<sup>9</sup> Ibid.

<sup>10</sup> Ibid.

<sup>11</sup> Ibid.

<sup>12</sup> Morton Thiokol, "Program Plan, Protection of Space Shuttle SRM Primary Seals," TWR-14359, May 4, 1984.

*May 23, 1984.*—NASA responds to Thiokol's plan, endorsing the Program Plan, supplementing it and expressing continued concerns about zinc chromate putty performance.<sup>13</sup> See Appendix V-C.

*May 30, 1984.*—A presentation by Thiokol personnel at the SRM Preboard Flight Readiness for STS41-D described the problems with STS41-C.<sup>14</sup>

*June 8, 1984.*—The Marshall Center Board review for STS41-D took place without mention of the SRM problems found on STS41-C, even though Thiokol had prepared briefing charts for the review.<sup>15</sup>

*June 18, 1984.*—MSFC memorandum from Miller to Horton mentioned zinc chromate putty installation discrepancies and recalled eroded/heat exposure O-ring experiences on QM-4, STS-2, STS-6, STS-11 (41B) and STS-13 (41C).

*June 18, 1984.*—The Level 1 Flight Readiness Review for STS41-D took place, but again without mention of the O-ring problems discovered on STS41-C.

*June 29, 1984.*—Scenario of hot gas jet impingement against O-ring is substantiated in a teleconference between Thiokol and MSFC.

*August 30, 1984.*—STS41-D was launched. Upon disassembly of the SRM casings at the Kennedy Space Center (KSC). O-ring erosion was found in both the right-hand forward field joint and the left-hand nozzle joint. The field joint erosion was 0.028 inches deep and extended over a 3 inch span in the 275 degree location.<sup>16</sup>

*September 12, 1984.*—Thiokol personnel discussed the problems with STS41-D at the STS41-G SRM Preboard Review.<sup>17</sup>

*September 19, 1984.*—For the first time, at the STS41-G Shuttle Projects Board review, Mr. Mulloy mentioned the term "allowable erosion." He used the same briefing charts on September 20 at the Marshall Center Board Review.<sup>18</sup>

Flights STS41-G and STS51-A successfully flew without O-ring damage, a fact that was mentioned in the SRM Preboards for STS51-A and STS51-C.<sup>19</sup>

*January 24, 1985.*—With a calculated O-ring temperature of 53 degrees F, STS51-C suffered erosion and blow-by in the two case field joints. The primary O-ring in the left-hand forward field joint was eroded 0.010 inches over a span of 4.25 inches at the 163 degree location, with a considerable amount of soot between the primary and secondary O-rings. The primary O-ring in the right-hand center field joint was eroded 0.038 inches over a 12.5 inch space at the 354 degree location. There was soot behind the primary O-ring over a 110 degree arc and the secondary O-ring was heat damaged over a span of 29.5 inches.

*January 31, 1985.*—At the STS51-E Preboard review, Thiokol personnel described the previous O-ring damage in detail as well as

<sup>13</sup> NASA, letter from John Miller, MSFC, "Evaluation of TWR-14359, 'Program Plan, Protection of Space, Shuttle SRM Primary Motor Seals,'" EP 25 (84-49), May 23, 1984.

<sup>14</sup> Rogers Commission Report, Volume II, p. H-1.

<sup>15</sup> Ibid.

<sup>16</sup> Ibid.

<sup>17</sup> Ibid., p. H-2.

<sup>18</sup> Ibid.

<sup>19</sup> Ibid.

joint performance. They also showed analytical predictions of the "maximum expected erosion."<sup>20</sup>

*February 12, 1985.*—Mr. Mulloy and Thiokol personnel presented a summary of STS 51-C O-ring related problems during a briefing to the Shuttle Projects Office Board. A portion of the problem summary on the briefing charts referred to a field joint O-ring blow-by problem as being an "acceptable risk." In this briefing the secondary O-ring was referred to as a "redundant seal using actual hardware dimensions" even though the field joint had been officially classified as Criticality 1 for two years.<sup>21</sup>

*February 14, 1985.*—Mr. Mulloy addressed the Marshall Center Board but did not comment on the STS 51-C O-ring problems in detail.<sup>22</sup>

*March 7, 1985.*—MSFC Memo to Mr. Mulloy from Mr. McCool. McCool was concerned that 14 months had elapsed since full scale diameter tests to provide data on zinc chromate putty behavior as it related to its effect on joint leak checks were requested. McCool pointed out that the only positive response from Thiokol was the Program Plan submitted on May 4, 1983.<sup>23</sup> (See Appendix V-E.)

*April 4, 1985.*—A letter from MSFC to Mr. Joseph Kilminster of Morton Thiokol requested specific sub-scale and full-scale tests on effects of zinc chromate putties on O-ring sealing integrity.

*April 12, 1985.*—STS 51-D was launched and, upon disassembly, erosion of the primary O-rings in both nozzle joints was discovered. The right-hand nozzle primary O-ring eroded to a depth of 0.068 inches over a 6 inch span at the 116 degree location. The left-hand nozzle primary O-ring eroded to a depth of 0.011 inches over a 2.12 inch span at the 14 degree location. There was no blow-by past either nozzle O-ring.

*April 17, 1985.*—The Shuttle Projects Board for STS 51-B was held without mention of seal problems. There was also no mention of seal problems associated with STS 51-C or 51-D at the Level 1 Flight Readiness Review on April 23, 1985.<sup>24</sup>

*April 22, 1985.*—Thiokol's evaluation of a second source for putty is issued. The evaluation states: "The Randolph Products putty is the only material presently qualified for use on the Space Shuttle Program. It is the desire of Morton Thiokol to evaluate and qualify a second source for a joint filler material." The evaluation went on to state, "The material has demonstrated poor processing characteristics and is moisture sensitive."<sup>25</sup>

*April 24, 1985.*—Problem Assessment System Record Number A07934, tracking damage to the field joint seals, contains the following entry: "At NASA request, a solution for O-ring erosion will not involve a radical design change. Therefore, the possible solutions under current investigation are linked to: (1) new O-ring [ma-

<sup>20</sup> Ibid.

<sup>21</sup> Ibid.

<sup>22</sup> Ibid.

<sup>23</sup> NASA, MSFC, Memo from Mr. Alex McCool, "Request for Initiation of Testing to Provide Data for Resolving the Burned O-Ring Seal Problem on the Space Shuttle SRM," EPOI (85-48), March 7, 1985.

<sup>24</sup> Rogers Commission Report, Volume II, p. H-2.

<sup>25</sup> Thiokol, S.H. Cardall, "SRM Evaluation of Second Source Joint Filler Material," TWR-14946, April 22, 1985, pp. 1-2.



terials] and/or diameter and (2) new vacuum putty and/or layup procedure.

*April 29, 1985.*—Flight STS 51-B was launched and when the Solid Rocket Boosters were recovered, it was found that the worst O-ring erosion to date had occurred. The left-hand nozzle primary O-ring eroded to a depth of 0.171 inches over a 1.50 inch space at the 54 degree location. There was evidence of considerable blow-by. The secondary O-ring was eroded to a depth of 0.032 inches over a 3 inch span which was also at the 54 degree sector. The right-hand nozzle O-ring eroded to a depth of 0.005 inches over a 3.50 inch span at the 14 degree location.

*May 8, 1985.*—Blowholes through the putty in one field joint from each of the STS 51-B SRMs was mentioned before the SRB Board for Flights STS 51-F and STS-51-G.

*May 29, 1985.*—The STS 51-G Shuttle Project Board took place without mentioning O-ring problems.<sup>26</sup>

*May 13, 1985.*—The Center Board Review for STS 51-G took place without mentioning O-ring problems.<sup>27</sup>

*June 11, 1985.*—The Level 1 Flight Readiness Review for STS 51-G took place without mentioning O-ring problems.<sup>28</sup>

*June 17, 1985.*—STS 51-G was launched, experiencing blow-by and erosion in both nozzle joints. The right-hand nozzle primary O-ring was eroded in two different places. The left-hand nozzle primary O-ring was also eroded and there was blow-by associated with all three locations.

*July 1, 1985.*—A combined Flight Readiness Review for the Marshall SRM Preboard, SRB Board, Shuttle Project Office Board, and Marshall Center Board was held at which Thiokol personnel presented an extensive analyses of the problems discovered on Flight STS 51-B.<sup>29</sup>

*July 2, 1985.*—Mr. Mulloy briefed the Level I Flight Readiness Review for STS 51-F and presented the STS 51-B O-ring erosion problem as a "closed item." Mr. Mulloy based this resolution on the use of a higher 200 psi leak check stabilization pressure and introduced, for the first time, a rationale for accepting secondary O-ring erosion. The Roger Commission would not find any reference to O-ring problems in any Flight Readiness Review associated with Flight STS 51-D or STS 51-G.<sup>30</sup>

*July 19, 1985.*—An attempt to form an SRM Erosion team at Thiokol "virtually failed" according to Mr. Roger M. Boisjoly because of lack of commitment on the part of Thiokol personnel.

*July 22, 1985.*—One of the engineers who appreciated the joint problem was Mr. Boisjoly of Morton Thiokol. In a "Progress Report" he wrote, "This problems has escalated so badly in the eyes of everyone, especially our customer, NASA, that NASA has gone to our competitors on a proprietary basis and solicited their experiences on their joint configuration."<sup>31</sup> (See Appendix V-G.)

<sup>26</sup> Ibid.

<sup>27</sup> Ibid.

<sup>28</sup> Ibid.

<sup>29</sup> Ibid.

<sup>30</sup> Ibid., p. H-3.

<sup>31</sup> Thiokol, Roger Boisjoly, "Progress Report: Applied Mechanics Center," July 22, 1985.

*July 29, 1985.*—STS 51-F was launched without O-ring erosion problems. However, there was a blowhole through the putty in the right-hand SRM nozzle and the primary O-ring was affected by heat.

*July 31, 1985.*—Boisjoly wrote an interoffice memo to R.K. Lund, Morton-Thiokol's Vice President of Engineering: On it, he warned that the rationale for flying the joint design was now suspect as a result of the secondary O-ring erosion on STS 51-B.<sup>31a</sup> See Appendix V-J.).

*August 7, 1985.*—The Shuttle project review for STS 51-I was conducted, followed on August 13 by the Marshall Center Board and on August 15 by the Level 1 Flight Readiness Review. The O-ring damage was noted at these reviews.

*August 19, 1985.*—Thiokol gave a presentation to Mr. Weeks, NASA Deputy Associate Administrator for Flight (Technical), and others at NASA Headquarters, which contained the following chart.

#### SUMMARY OF SIGNIFICANT OBSERVATIONS

All joints:

- Seal damage always has associated putty blowhole
- Putty blowholes exist without resultant seal damage
- Soot blowby can occur away from a putty blowhole
- Frequency of O-ring damage has increased since incorporation of:
  - Randolph putty;
  - Higher stabilization pressures in leak test procedure;
  - High performance motors.
- Randolph putty is more susceptible to environmental conditions such as humidity and temperature.
  - Can become leathery in dry conditions;
  - Becomes extremely sticky in moist conditions and in some cases begins to disintegrate.<sup>32</sup>

*August 20, 1985.* A Thiokol interoffice memo mentioned that a Nozzle O-ring Investigation Task Force had been formally instituted, stating, "As you are aware, we have experienced O-ring damage on a random basis in the case field joints and prevalently in the case/nozzle joint on the Space Shuttle Booster Motors. The frequency had increased in recent flights. While we have not compromised the performance of any motor to date, the result of a leak at any of the joints would be catastrophic."

*August 27, 1985.* Flight STS 51-I was launched, after which it was discovered that there was primary O-ring erosion in two locations on the left-hand SRM nozzle joint. At the reviews for STS 51-J, which occurred on September 9, 1985, September 17, 1985, September 19, 1985, and September 26, 1985, the O-ring erosion noted on STS 51-I was merely itemized as, "left-hand nozzle to case primary O-ring erosion within experience base." There was no O-ring damage on Flight STS 51-J.

*August 30, 1985.* One year and four months after the original drafting of Thiokol's Program Plan TWR-14359, for improvement of Space Shuttle SRM Motor Seals, the revised version of the plan was issued.

<sup>31a</sup> Thiokol, Roger Boisjoly, "SRM O-Ring Erosion/Potential Failure Criticality," Memo 2870: FY 86: 073, July 31, 1985.

<sup>32</sup> Rogers Commission Report, Volume II, p. H-73.

October 1, 1985. R.V. Ebeling of Morton Thiokol submitted a weekly activities report to A.J. McDonald, Director, Solid Rocket Motor Project, with copies to J. Kilminster and others, which included the following statements:

*Executive Summary.* HELP! The seal task force is constantly being delayed by every possible means. People are quoting policy and systems without work-around. MSFC is correct in stating that we do not know how to run a development program.

\* \* \* \* \*

5. The allegiance to the O-ring investigation task force is very limited to a group of engineers numbering 8-10. Our assigned people in manufacturing and quality have the desire, but are encumbered with other significant work. Others in manufacturing, quality, procurement who are not involved directly, but whose help we need, are generating plenty of resistance. We are creating more instructional paper than engineering data. We wish we could get action by verbal request but such is not the case. This is a red flag.

(See appendix V-H.)

October 4, 1985. Roger Boisjoly's Activity Report identified problems in obtaining support from Mr. Kilminster for the O-Ring Investigation Task Force.

October 30, 1985. STS 61-A experienced erosion of the right-hand nozzle primary O-ring to a depth of 0.075 inches over a 13 inch space at the 97 degree location. There was also blow-by past the primary O-rings in the center and aft field joints on the left-hand SRM. But these problems were not discussed at the STS 61-B SRB Board Review on November 4, 1985. However, Mr. Mulloy included a note at the Shuttle Project Board Review on November 6, 1985, "SRM Joint O-ring performance within experience base."

November 18, 1985. Mr. Mulloy briefed the Level 1 Flight Readiness Review stating, "Post flight inspection of SRM revealed hot gas erosion of primary nozzle/case joint-O-ring on right-hand SRM—Within previously accepted experience."

November 20, 1985. Thiokol briefing document TWR-15349, "SRM O-ring Task Force Status and QM-5" Recommendations, presented new seal design concepts and recommendations for Qualification Motor-5 testing on February 20, 1986.

November 26, 1985. STS 61-B experienced primary O-ring erosion in both nozzle joints. There was also blow-by past the primary O-ring in the left-hand nozzle joint. These observations were noted at the STS 61-C SRB Board Flight Readiness Review on December 2, 1985.

December 4, 1985. At the STS 61-C Shuttle Project Board, Mr. Mulloy noted "SRM joint O-ring performance within experience base." The Commission's copy of the December 9, 1985, Marshall Center Board briefing was incomplete; however, at the December 11, 1985, Level I Flight Readiness Review, it was reported that there were "No 61-B flight anomalies."

*December 11, 1985.* Thiokol management holds a Solid Rocket Motor Flight Readiness Review for STS 51-L. No discussion of O-ring anomalies occurs.

*December 17, 1985.* Larry Wear holds a Flight 51-L Solid Rocket Motor Project Flight Readiness Review at Marshall Space Flight Center.

*January 3, 1986.* The Level III Flight Readiness Review for Flight 51-L takes place at Marshall. SRB recovery system changes are the primary point of discussion.

*January 9, 1986.* Larry Mulloy makes his Flight 51-L presentation at the MSFC Shuttle Projects Office Readiness Review. SRB parachutes are discussed. O-rings are not.

*January 12, 1986.* STS 61-C experienced nozzle Joint O-ring erosion and blow-by and a field joint O-ring was eroded 0.011 inches over an 8 inch span at the 162 degree location. There was blow-by past the primary O-ring in the left-hand nozzle joint between the 255 degree and 335 degree locations. The primary O-ring in the left SRM aft field joint was eroded 0.004 inches over a 3.5 inch span at the 154 degree location.

*January 13, 1986.* Marshall Space Flight Center 51-L Readiness Review. Mulloy again does not mention O-ring anomalies.

*January 14, 1986.* Mulloy's Flight 51-L presentation to the Level II Flight Readiness Review indicates there were "no 61-C flight anomalies."

*January 15, 1986.* During the STS 51-L Level I Flight Readiness Review, Mr. Mulloy noted that there were "No 61-C Flight Anomalies," and that there were "No major problems or issues."

*January 25, 1986.* According to Mr. McDonald, Mr. Mulloy mentioned that 61-C had suffered O-ring erosion "within experience base" at the STS 51-L L-1 Flight Readiness Review.

*January 26, 1986.* The *Orlando Sentinel* printed an article titled, "Bitter freeze is expected to clobber state Tuesday."<sup>32a</sup>

*January 27, 1986.* Thiokol and Marshall personnel spend approximately three hours in a teleconference debating the effect that predicted low temperatures will have on the performance of the O-ring seals.

*January 28, 1986.* The ice/frost evaluation team visits Launch Complex 39B at 1:45 a.m., 6:45 a.m. and 10:30 a.m. Meeting with Rockwell personnel concluded with a decision to continue the launch countdown.

*January 28, 1986.* STS 51-L was launched at approximately 11:38 a.m. Eastern Standard Time.

## 2. SUMMARY OF CASING JOINT DESIGN

### *Issue*

Why did the aft field joint between the steel containers that hold the Solid Rocket Motor propellant fail to contain the burning gases of the propellant during lift-off and flight operations?

<sup>32a</sup> John Wark, "Bitter Freeze is Expected to Clobber State Tuesday," *The Orlando Sentinel*, Jan. 26, 1986, p. B-3.

### *Findings*

1. The design of the field joint was unsatisfactory and could not reliably contain the burning propellant gases under the range of operating conditions to be expected during the lift-off and flight phases.

2. The O-ring materials and putty used in the design of the joint were unsatisfactory as used on the Shuttle, particularly during the winter months. Furthermore, neither NASA nor its contractor, Morton Thiokol, can adequately control the quality or consistency of these kinds of materials, which are made from recipes known only by the manufacturer and which can be changed without certification and approval.

### *Recommendations*

1. NASA should write and issue a new and more accurate performance specification which would cover the full range of thermal and structural requirements for the Solid Rocket Motors, with an adequate factor of safety for unusually low temperatures.

2. The Committee concurs with the Rogers Commission Report Recommendations on new joint design, but believes it is more appropriate to be more explicit in identifying the weaknesses in the joint design that need correction.

3. The field joints of the Solid Rocket Motors should be redesigned to account for the following features while providing a significant factor of safety:

- a. Movement in the joint;
- b. Proper spacing between tang and clevis;
- c. Seals made to withstand high and low temperatures under all dynamic thermal and structural loadings;
- d. Adequate sealing without the use of putty;
- e. Protection against insulation debonding and propellant cracking.

### *Discussion*

This section is a summary of Section VII, Casing Joint Design. For details and substantiation of the statements made in this summary, refer to Section VII.

The evidence, consisting of recovered pieces of the right Solid Rocket Motor casings, photographs of smoke and flame emanating from the right Solid Rocket Motor and telemetry data transmitted from STS 51-L back to Mission Control at the Johnson Space Center verify the failure of the aft field joint of the motor.

As mentioned earlier, NASA's performance specifications did not anticipate operations at temperatures below 31 degrees, a temperature that might occur in Florida during the winter months. The design of the joint was unsatisfactory to provide for the low temperatures or water in the joints that existed on January 28. While it was based on an existing similar rocket casing joint design that had been successful, the design was changed to accommodate the manufacturing requirements of the larger sized shuttle rocket motors. There were even some features of the revised design that indicated the changes were an improvement. It was easier to assemble in the field and it had a second O-ring. The designers

thought if the first O-ring failed, the second would surely hold the propellant gases.

The casing joints, as described in the Introduction, have to withstand various structural loads, which change dramatically as the shuttle is assembled, through launch operations, separation of the Solid Rocket Booster and retrieval from the ocean. The joint is dynamic; the components move under these loads. The loads carried by the aft field joint are different from those carried by other joints. The design, based on these loads and 24 successful missions, appeared satisfactory.

One of the loads, however, that of the propellant gas pressure, was not adequately accommodated. The zinc chromate putty, intended to protect the O-rings from this high temperature and relatively high pressure gas, frequently failed and permitted the gas to erode the primary O-rings.

Instead of redesigning the joint, NASA and Thiokol persisted in trying to fix the problem by changing leak-test pressures, changing the size of the O-rings, and trying to control proper spacing between the tang and clevis where the O-rings were located.

Complicating this problem, two of the materials used in the joint, the putty and the fluorocarbon elastomer O-rings, were not suited to the task of containing the propellant gas under the full span of Shuttle operating conditions. The behavior of the fluorocarbon elastomer O-rings was something of a mystery to NASA and its contractor. The material was "proprietary," meaning that the constituents used were known only to the manufacturer. Fluorocarbons are expensive, so fillers are frequently added to reduce the cost of the material. These materials behave unlike most other materials. The particular material used in the manufacture of the shuttle O-rings was the wrong material to use at low temperatures.<sup>33</sup> Nitrile or silicon based materials would have demonstrated better performance characteristics.

It became necessary to find a new putty when the original supplier, Fuller O'Brien, stopped making it because it contained asbestos. The characteristics of the new putty changed substantially in response to the quantity of water in the air and it was difficult to apply in both the dry climate of Utah and the dampness of Florida. Its performance in use was highly unpredictable. Again, NASA and its contractor tried to make up for the unsatisfactory material by storing it under refrigeration prior to application in Florida.

After ignition of the solid propellant in the SRM, it was learned that the O-ring could be seated by the motor's gas pressure yet still suffer erosion as the hot gases came in contact with it. As mentioned, O-ring erosion was noted after various flights and tests. Also seen was damage given the name "blow-by", a condition where erosion was not necessarily present but where there was evidence that the propellant gas had bypassed the primary O-ring. But rather than identify this condition as a joint that didn't seal, that is, a joint that had already failed, NASA elected to regard a certain degree of erosion or blow-by as "acceptable." To make matters worse, confidence was mistakenly obtained from a mathemati-

---

<sup>33</sup> NASA's primary concern was having a very durable material with excellent high temperature performance characteristics.

cal model which suggested that if the erosion did not exceed a specific depth, the O-ring would still seal that joint. In cases where the erosion did exceed the maximum predicted by the model, NASA expanded its experience base to cover this increased damage.

As the joint seals continued to exhibit erosion or blow-by or both, more research illustrated the importance of maintaining proper gap spacing between the tang part of the joint and the O-ring face of the inner clevis leg. Too little space, and the O-rings would not seal. Too much space, and again the seals would fail. Since the joint opens, or "rotates," when the Solid Rocket Motor is ignited, maintaining proper spacing was difficult if not impossible. The maintenance of such close tolerances in spacing, on the order of 20 thousandths of an inch, while joining 300,000 lb. segments that have been bent during shipment, was not sufficiently provided for in the design. Months passed until, in 1985, engineers at NASA recognized that the design was unsatisfactory. In fact, NASA had written to several other contractors soliciting help with the joint problems. Unfortunately, in the quest to meet schedule and budget, the warnings of the engineers were not heeded.

Based on the above conditions and the evidence, the Committee has endeavored to determine the way in which the joint failed; recognizing that such a determination is difficult, if not impossible, to make with 100% certainty.

The following is the most probable sequence of the joint failure:

1. The failure occurred in the lower assembly joint near a strut that connects the Solid Rocket Booster to the External Tank.

2. At that location, the spacing between the two casings was too small to facilitate a tight seal.

3. Also, at that location, there probably existed a hole through the insulating putty, which would act as a conduit concentrating the hot propellant gas on the primary O-ring.

4. The freezing temperatures reduced the capability of the O-rings to seal. Worse, at this particular location, near the connecting strut, the joint was made even colder by the further loss of heat caused by the direct connection to the liquid hydrogen fuel, at 423 degrees below zero, in the external tank.

5. When the Solid Rocket Motors were ignited, the pressure from the motor changed the spacing between the casings. Among other effects, this can prevent the secondary O-ring from sealing.

6. Seven inches of rain fell while the shuttle was being prepared for launch. Water very likely penetrated the joints and froze. Ice in the joints could have dislodged the secondary O-ring even if the change in spacing, coupled with a cold and stiff O-ring, did not.

7. Smoke at ignition occurred at a location near the connecting strut to the external tank. At that location, the primary O-ring was either unseated or eroded and the secondary O-ring was unseated.

8. The primary O-ring was sealed at other locations around the motor casings.

9. The breach in the primary O-ring clogged with burned char and aluminum oxide from the propellant in less than 3 seconds, causing the smoke to stop.

10. At 37 seconds, 45 seconds and 58 seconds into the flight, the Space Shuttle encountered heavy turbulence, which forced the

steering controls to cycle through changes more severe than previous flights.

11. After throttling back to 65% power as planned, at 57 seconds, power was increased to 104%.

12. The combined effect of the turbulence and the increase in power caused the material which clogged the joint to break free, reopening the joint.

13. A flame from the right Solid Rocket Motor was seen at the location near the connecting strut.

14. This flame burned through the external tank and caused the destruction of the shuttle.

Since the technical faults in the joint design must be corrected if safe shuttle flight is to resume, this subject has been discussed in more detail in Section VII.

### 3. TESTING AND CERTIFICATION

#### *Discussion*

In developing the Solid Rocket Motor, Thiokol concentrated most of their efforts and concerns on the proper design and performance of the propellant. There is no question that this is where the emphasis on safety and performance is required. The propellant is a high performance material, dangerous to manufacture and handle and which must be prepared to the highest quality standards. Consequently, testing and certification of the propellants, as well as its performance, was carefully controlled. This does not mean that the design of the casings was ignored. Considerable attention was paid to the design of the casings because they were larger than seen on any previous Solid Rocket Motor, because this Solid Rocket Motor would be used on a manned flight system, and because these particular motors would be brought back, refurbished and reused. Given this background, the testing of the joint was included in static firing tests. While there were no special tests conducted to confirm and certify the joint as a separate item, analysis was performed to assure that the joint was adequate. Later, during the operation of the Solid Rocket Motor, it was discovered that the performance of the joint was unsatisfactory.

### 4. MANUFACTURING

The Solid Rocket Motor is 126 feet long and 12 feet in diameter. The propellant weighs 1.9 million pounds and the average thrust is 2.3 million pounds. Fifty of these motors have been produced. The segmented Solid Rocket Motor case is roll formed from D6AC steel. The case is weld-free and consists of eleven segments. The propellant is made in batches at 135 degrees F and it takes 40 to 43 of these batches to load one casting segment. One segment includes two steel cases which are joined in the factory. The content and quality of the materials used to make the propellant is inspected prior to mixing. The motor is designed for a short burn time (122 seconds) and therefore has a high mass flow which requires a large burning surface. In manufacture, either new steel casings or previously used casings are employed. The first step is to apply the rubber insulation liner around the inside of the casings. The insu-



lation is removed from a roll and spread around the inside of the casings with special tooling. After application it is cured in place in an autoclave. After the casings have been insulated, they are placed in a casting pit. The propellant is then poured into the casings under vacuum. The propellant is then cured and the casings are removed from the pit. There is no indication that there were any manufacturing defects that contributed to the loss of the Challenger.

## 5. STACKING OPERATIONS

### *Issue*

Was there any damage to the casing joints or contamination that occurred during the stacking operations when the Shuttle was assembled in the Vehicle Assembly Building (VAB) that could have contributed to the failure?

### *Finding*

There was no evidence of joint contamination, fracture, or other damage from foreign objects or due to casing ovality that contributed to the joint failure. Although certain problems occurred during stacking and the procedures were violated once, there was no evidence that these events contributed to the Flight 51-L accident.

### *Discussion*

The discussion of the assembly of the aft field joint on the right hand Solid Rocket Booster is drawn from the "STS 51-L SRB Joint Mate Review Team" report<sup>33a</sup> The report was provided to Committee staff during the Committee's trip to KSC on June 6, 1986.

There were 24 Solid Rocket Booster sets (48 SRBs) stacked prior to STS 51-L. The stacking experience of the technicians involved in STS 51-L ranged from 5 to 20 stacking operations. Sixty percent of the technicians and all of the supervisory personnel, including lead technicians, had participated in the 14 stacking operations performed since the Shuttle processing contract was awarded to Lockheed. Thiokol managed the stacking operations for Lockheed under a subcontract. The NASA Accident Review Team found that all personnel assigned to the stacking of STS 51-L were experienced and qualified to perform their assigned tasks.

Aft segment receiving inspection and processing in the Rotation, Processing and Surge Facility (RPSF) was normal. No problems were reported relative to the aft segment clevis during offload from the railcar, mate to the aft skirt, aft booster assembly, or in preparation for transfer to the Vehicle Assembly Building (VAB) for stacking. Some surface defects were identified on non-sealing surfaces of the aft segment clevis, but were found not to exceed the specification in the Operations and Maintenance Requirements Specification (OMRS) document. There were no defects identified in the clevis O-ring grooves. The aft segment was processed normally in the RPSF to prepare for stack.

---

<sup>33a</sup> NASA, J. Robert Lang, KSC, "STS 51-L SRB Joint Mate Review Team Report," March 18, 1986.

A problem was reported at the 165-168 degree location where a segment case-to-insulation bondline separation 0.109 inch in depth (longitudinally) was found. The OMRS document specifies no separations in excess of 0.050 inch. A Material Review Board (MRB) repair was approved and the separation was filled with an asbestos float-filled, liquid epoxy resin sealant. This repair is standard for this type of separation, and has been performed on numerous segments. Some surface defects were identified on the tang, but none were found to exceed specification.

The right aft booster assembly was transferred from the RPSF directly to the VAB transfer aisle. Positioning of the aft booster assembly on the Mobile Launch Platform (MLP) holddown posts was normal. One iteration of shimming was performed and the subsequent holddown post strain gauge output indicated proper distribution of aft booster assembly loads.

Holddown hardware was installed and stud tensioning began with ultrasonic measurement of stud initial lengths. A problem was reported at holddown post #1 when ultrasonic measurements indicated a stud length twice the actual. The stud and associated hardware at post #1 were removed for offline bench testing. The problem was isolated to a faulty ultrasonic transducer. While awaiting replacement hardware, studs at holddown posts #3 and #4 were tensioned satisfactorily. The stud at holddown post #2 was tensioned but adequate margin was not attained.

This problem in tensioning studs at holddown posts #1 and #2 led to a revision in the schedule. All left hand Solid Rocket Motor segments were stacked while problems on the right hand side were resolved. This procedure had been employed in one-third of the previous stacking operations and was not an uncommon method of stacking.

After installation of the replacement hardware at holddown post #1, studs at posts #1 and #2 were tensioned. The replacement stud at post #1 was brought up to satisfactory tension, but concerns over stud tension at post #2 prompted engineering to request that a problem report be generated.

Engineering determined the tension (approximately 690,000 lbs.) was adequate for SRB stacking, but marginal for launch loads. Therefore, stud removal and replacement was planned after SRB stack but prior to Orbiter mate.

While holddown post stud tensioning proceeded, preparation and inspection of the aft segment clevis was put in work. No problems were identified on the aft segment clevis during this inspection. Since a stacking delay was evident, the clevis was secured and sealed to maintain inspection integrity until stacking could resume.

A Solid Rocket Motor configuration change was released as a result of a handling incident. The SRM-25 left forward center segment was damaged during processing in the RPSF.<sup>34</sup> Deviation Approval Request (DAR) Number RWW-376R1 was approved to replace the damaged segment with a left forward center segment for SRM-26 motor set. In order to prevent flight performance imbalance, the right aft center segment was also reassigned from SRM-

---

<sup>34</sup> Mishap Report 86-0024, R.G. Smith, "Report of SRM Handling Ring Mishap Investigation Board, Dec. 13, 1985.

26 to the SRM-25 flight motor set. The SRM-26 right aft center segment was transported to the VAB for stacking.

While this segment was outside the VAB, a storm occurred. A Problem Report was generated as rain water was reported leaking from under the segment protective covers. The segment was brought into the VAB transfer aisle and hoisted for pre-stack inspection. At this time, all visible moisture was removed from the aft surfaces of the segment. Inspections were performed and no problems were identified as a result of rain water intrusion. The MRB repair of the separation of insulation from the segment case located at 165/168 degrees was reinspected and final acceptance was verified. A complete inspection of tang surfaces and aft insulation surfaces was performed and no problems were identified.

The use of this segment violated assembly procedure which requires that the segments be protected from direct water entry and it should not have been employed. While there is no evidence of a direct connection to the joint failure, the decision to use this aft center segment was a compromise that need not have been made.

The aft segment clevis diameter was measured at six locations and corresponding measurements were taken of the aft center segment tang. Measurements indicated that a potential for interference existed along the 0/180 and 30/210 degree axes where the tang diameter was larger than that of the clevis. The normal procedure for changing the shape (ovality) of the tang was initiated. The procedure calls for reconfiguration of the segment lifting beam from a four-point to a two-point lift configuration to decrease the tang outside diameter along the axis of interference. The procedure was followed and after stabilization, a decrease in tang diameter of 0.178 inch was measured along the axis of potential interference. Shuttle Processing Contractor (SPC) engineering was called on to evaluate the latest overall characteristics of the joint. At that time the aft center tang was larger in diameter than the aft segment clevis by more than 0.31 inches along the two axes, 0/180 and 30/210.

These measurements still indicated a potential for interference based upon normal KSC experience. SPC engineering determined that additional deflection of the aft center segment case was necessary and prescribed installation of the SRM Circumferential Alignment Tool along the 16/196 degree axis of the tang. The Circumferential Alignment Tool was installed and maximum hydraulic pressure was applied (1200 psig), producing a deflection of 0.196 inch. Later an unspecified torque on the Circumferential Alignment Tool tension rod nut produced an additional deflection of 0.040 inch. This additional torque caused an additional load and exceeded the safe working limit of the tool. Technicians noticed an increase in hydraulic pressure on the pumping unit gauge to 1300 psig at the time torque was applied. This pressure indicates a force of up to 3250 pounds may have been applied to the segment case. Currently, a force of 5000 pounds may be applied to the segment case. The safety limits of the Circumferential Alignment Tool were exceeded (safety factor reduced to 1.2), but the force applied to the segment case was still well below the established maximum. However, the procedure was determined to be inappropriate by the post-accident investigation.

The alignment tool used on the aft center segment of STS 51-L's right hand Solid Rocket Motor is now considered inappropriate by NASA due to the concentrated loads applied at two points. A new alignment tool is now being designed. However, the use of this tool did not appear to have contributed to the STS 51-L's accident.

With the Circumferential Alignment Tool installed, the right aft center segment was hoisted from the transfer aisle and positioned above the aft segment in the VAB High Bay. Installation of primary and secondary O-rings was performed, and no problems were identified. Closeout photographs were then taken showing the O-ring and zinc chromate putty installation.

The joint mating operation proceeded with final inspection of the greased joint surfaces. No problems were identified during engagement of the tang into the clevis, aided by the nearly co-planar relationship of the mating surfaces (within 0.15 inch). The joint mate was completed with installation of all clevis pins and pin retainer clips per the normal procedure. No difficulties were encountered.

After disconnection of the segment lifting beam, the SRM field joint leak test was performed. Following the 200 psig pressurization, the 50 psig decay test was performed and zero pressure decay was recorded, indicating successful assembly of the joint (maximum allowable decay is 1.0 psig over a 10 minute period).

Field joint closeouts were performed in the normal fashion. No problems were reported during pin retainer band and cork insulator installation. Data also indicated normal application of the bead of grease around the seam of the joint. Installation of the systems tunnel floor splice plate across the field joints at the 90 degree location completed the closeout.

Because of its unique design, the clevis of the aft case must always be used as the field joint at the forward end of the aft segment. It was previously flown on the left booster segment on STS 51-C. It was also utilized in qualification test motor QM-4 which was static test fired at Thiokol's Utah plant.

The field joint tang of the STS 51-L aft center segment (serial number L60 had flown previously as forward center segment to aft center segment field joint tang on the left booster on STS 41-D.

In a memo to J. Harrington of NASA's Data and Design Analysis Task Force on February 24, 1986, the Chairman of the SRB Joint Mate Review Team noted the conclusion that the 200 psig O-ring seating operation could produce a blowhole in the putty. Such a blowhole would not be known prior to launch. Since the putty is intended to provide a heat shield to protect the O-rings, the O-rings would be unprotected in cases where blowholes occurred.

## 6. SUMMARY OF LAUNCH OPERATIONS

### *Issue 1*

How was the decision to launch STS 51-L arrived at and why was it wrong?

### *Findings*

1. The Flight Readiness Review for STS 51-L was conducted in accordance with established procedure.

2. The decision to launch STS 51-L was based on a faulty engineering analysis of the SRM field joint seal behavior.

3. Compounding this erroneous analysis were serious ongoing weaknesses in the Shuttle Safety, Reliability, and Quality Assurance program which had failed to exercise control over the problem tracking systems, had not critiqued the engineering analysis advanced as an explanation of the SRM seal problem, and did not provide the independent perspective required by senior NASA managers at Flight Readiness Reviews.

4. The initial response of Marshall managers to the attempts of Thiokol engineers to raise the issue of temperature effects on the SRM seals caused Thiokol management to discount proper technical concerns and engineering judgement in their recommendation to launch.

5. The Director of Marshall's Shuttle Projects Office may have violated NASA's Flight Readiness Review policy directive by failing to report the results of the January 27 teleconference to the Associate Administrator for Space Flight.

6. The decision of the STS Program Manager to launch despite the uncertainty represented by ice on the Fixed Service Structure was not a prudent effort to mitigate avoidable risks to the Shuttle.

7. The Launch Director failed to place safety paramount in evaluating the launch readiness of STS 51-L.

8. No launch should have been permitted until ice was cleared from the platform leading to the pad escape system.

9. Ice Team personnel and Rockwell contractors properly conveyed their inability to predict the post-ignition behavior of ice.

10. Post-flight analysis indicated that ice did not exhibit the behavior predicted by analysis, and that ice traversed a distance sufficient to strike the Shuttle during lift-off.

11. Failure to enforce a clear requirement for definite readiness statements contributed to failures in communication between NASA and its contractors during launch preparations.

### *Discussion*

Significant in the loss of Challenger was NASA's decision to launch the Shuttle on January 28. The Rogers Commission and the Committee investigation found sufficient evidence to indicate that STS 51-L should not have been allowed to lift off until a number of problems had been corrected. The Committee has examined documentation made available to the Rogers Commission and has reviewed recordings made of conversations among personnel in KSC Firing Rooms on January 27 and 28 in developing its analysis.

What seems evident in the Committee's review of this material is that clear indications existed on the morning of January 28 arguing that a launch of the Shuttle vehicle would not be a prudent decision. Significantly greater risks were present for this launch attempt than were usually found during a launch of the Shuttle. Despite these signals, some of which reached officials with the authority to delay the launch, STS 51-L was allowed to proceed. The Committee is disturbed that expected safeguards in the launch decision process failed to operate.

Specifically, this section examines the inability of the Flight Readiness Review procedure to compensate for poor technical anal-

ysis in preparing the Shuttle system for launch. Also, the efforts initiated by Thiokol engineers to delay the launch until SRM seal temperatures had risen were unsuccessful, nor were their arguments conveyed to the Associate Administrator for Space Flight, as NASA policy apparently requires. Finally, the heavy ice on the pad Fixed Service Structure led NASA's ice team leader to recommend that the launch be scrubbed, but his objections were apparently never conveyed to the STS Program Manager. The Committee concludes that sufficient warning of the risks to STS 51-L was available, and the launch therefore should not have occurred. Readers are directed to Section VIII-A of this report for a complete discussion of each of these areas.

NASA has developed a highly involved procedure to prepare a Shuttle mission for flight. Much of this preparation is discussed in Section VI-A.2.b. In the period immediately preceding a launch, project and program managers participate in a number of meetings that together are known as the Flight Readiness Review. In the case of the Solid Rocket Motor, the apparent cause of the accident, eight levels of review were required to certify the flight readiness of the STS 51-L hardware. (See Table I for date and scope of these reviews)

Flight Readiness Reviews employ the so-called "delta review" concept, meaning that the data presented only represents those elements on the previous flight that fall outside the expected performance of the hardware. The responsible project or program manager must then explain the failure to the satisfaction of the review board and describe the steps that have been taken to assure that the situation will not recur on the upcoming flight. In the case of STS 51-L, however, this concept permitted the SRM seal erosion problem to evade scrutiny. STS 61-C, the mission immediately preceding 51-L, did not fly until halfway through the 51-L FRR cycle. Thus, there was no previous mission to obtain data from. Only at the last stage of the cycle, at the L-1 review, did the Associate Administrator learn that the SRM seal erosion problem had been noted again. Mr. Mulloy's presentation characterized the situation as "within the experience base," according to Thiokol's Mr. McDonald.

The history of SRM seal erosion demonstrates the effect that faulty engineering analysis has on the Flight Readiness Review process. Thiokol and Marshall engineering personnel declared the seal erosion problem to be "acceptable," even though the seal design clearly recognized that the elastomeric O-ring seals were not designed to stand up to propellant gases during flight. Relying on a computer model of the situation and a limited battery of tests, Marshall continued to present the situation in Flight Readiness Reviews as "within the experience base;" that is, the deterioration in the seals was no worse than previous cases and thus no concern was warranted.

It is the conclusion of the Committee that the Flight Readiness Review operated as well as its design permitted in the case of STS-51-L. See Section VI-B.1.b.3. It seems clear that the process cannot compensate for faulty engineering judgement among participants. Had the engineering analysis led Marshall to a different conclusion about the severity of the SRM seal erosion problem, the system

would have reacted to these concerns long before the 51-L Flight Readiness Review.

If the Flight Readiness Review process did not fail, however, why was STS 51-L launched? The Committee is seriously concerned by the fact that information indicating that the SRM seals might fail became available in time to delay the launch, and yet these concerns were overridden. Engineers from Marshall and Thiokol argued for hours on the night of January 27 regarding the effect of temperature on the performance of the seals. In the end, Thiokol managers chose to recommend that the launch proceed over the objections of their engineering staff.

In hindsight, it is unfortunate that Thiokol engineers did not present their objections in terms of developing a new launch commit criteria on the SRM joint seal temperature. Doing so would have required that the STS Program Manager would have had to listen to the engineers' presentation. It would also have guaranteed that a more rigorous analysis of the situation would have been forthcoming, simply to explain why the situation had been allowed to continue for so long. Even so, the Committee's investigation indicates that these discussions should have been brought directly to the attention of the Associate Administrator for Space Flight by Marshall's Shuttle Project Office Director. The Committee's investigation also questions whether doing so would have altered the decision made on January 28. (See Section VI-B.1.b.4)

The question remains: Should the engineering concerns, as expressed in the pre-launch teleconference, have been sufficient to stop the launch? The Committee concludes the answer is yes. Thiokol's recognized expert on SRM seals had evidence he believed conclusive and sufficient. His opinion, in the absence of evidence to the contrary, should have been accepted until such time as better information became available.

Finally, the Committee examined the taped conversations among NASA and Rockwell personnel discussing the ice that covered the pad's Fixed Service Structure on January 28. Because the temperature dropped below freezing, NASA had permitted critical water systems on the pad to run during the night. The pad drainage system could not handle the water flow, and allowed water to spill out onto the gantry platforms and freeze.

NASA personnel were sent to the pad to examine the situation and determine whether the situation posed a threat to the Shuttle. What they found was described by Rockwell personnel as "something out of Dr. Zhivago." Icicles hung from platforms and handrails, and could be easily broken off. Sheets of ice covered the gantry platforms, including the platform across which the crew would have to run if it became necessary to use the pad escape system. The ice team leader indicated that he felt the situation was a distinct hazard to the Orbiter thermal protection system, since Main Engine ignition would likely release a great deal of ice debris. Blown by the wind or sucked up by the engines and boosters, the ice could inflict damage on the delicate silica tiles that made up the Orbiter heat shield. Asked for his opinion, the ice team leader recommended that the launch be scrubbed until the ice had been removed from the gantry.

Rockwell personnel in Downey, California, expressed similar concerns about the situation after seeing the pad on television. They attempted to determine what would happen to the ice by use of computer modelling, but were not satisfied with the result. Rockwell's chief engineer finally concluded that the situation was little better than "Russian roulette." The company's liaison at KSC noted that the situation was much worse than the threat from ice in the liquid oxygen vent arm, which NASA considered a definite threat to the Orbiter. However, the STS manager, relying on an analysis by engineers at KSC and JSC (using the same model Rockwell found inadequate), decided to launch.

As a whole, the Committee's review of the decision to launch STS 51-L on January 28 indicates a number of questionable practices. It is not clear to the Committee why so many warnings went unheeded by NASA personnel that morning. What is certain, however, is that the Associate Administrator for Space Flight and the Associate Administrator for Safety, Reliability and Quality Assurance should restore a more conservative set of launch rules prior to resuming flights of the Space Transportation System.

### *Issue 2*

Should firing room personnel be allowed to waive launch commit criteria or equipment redlines during a launch countdown without a well-developed technical reason for doing so?

### *Finding*

NASA's management waived its own launch commit criteria on January 28, 1986, without a valid technical reason for doing so.

### *Discussion*

Conversations obtained from the Operational Intercommunication System (OIS), used by the launch team during Shuttle countdowns, indicates that launch commit criteria were waived without sufficient technical justification on January 27 and 28. The Committee reviewed tapes and transcripts which indicate that engineering personnel wrote a waiver for launch commit criteria on the External Tank nose cone temperatures that justified using lower temperatures on the basis of a backup procedure that was invalid.

Should the temperature sensors in the ET nose cone fail, according to Launch Commit Criteria 5.1-4, a secondary procedure correlating data obtained from telemetry channels with a previously derived curve could be substituted. The curve, however, was limited to an ambient temperature range of 40-99 degrees Fahrenheit. Ambient temperatures were outside this range during the countdown, meaning that the backup procedure could not be used. According to the Launch Commit Criteria, exceeding the lower temperature limit could cause "inaccurate ullage pressure readings." Since these pressure readings might be significant in operation of the Shuttle's main engines, inaccuracies might have threatened the safety of the mission. During flight, pressure in the fuel tanks for the main engines is maintained by bleeding off excess gas from the main engine heat exchangers and circulating it back into the External Tank. Misreading the pressure might cause the Orbiter gen-



eral purpose computers to over- or underpressurize the tanks and disrupt fuel flow to the engines.

Also, in discussion with Thiokol personnel during the latter stages of preparing this report, the Committee learned that liquid hydrogen remained in the External Tank throughout the night of January 27. Notwithstanding the effect this had on heat transfer through the aft attachment strut (see Section VII on casing joint design), this indicates that criteria requiring an eight-hour period between tanking cycles may have been violated. This is significant in that, had the tanking cycles been carried out as required, launch of STS 51-L would have taken place in the afternoon of January 28 or the next day. The Committee has not confirmed this possibility.

## 7. RETRIEVAL, TRANSPORTATION, AND REFURBISHMENT

### *Issue*

Were the motor casings used on STS 51-L damaged as a result of the retrieval, transportation and refurbishment operations following previous launches?

### *Finding*

There was no evidence of damage to the casings or joint due to prior use or preparation for reuse.

### *Discussion*

The aft field joint on Flight 51-L was between two casings that were used previously on STS 51-C. After approximately two minutes of burn-time during the launch operation, the Solid Rocket Boosters are separated from the External Tank, at which time they fall toward the ocean for a considerable distance. Before impact, parachutes are deployed from the Solid Rocket Boosters to slow their decent and minimize impact forces. The Solid Rocket Boosters strike the ocean at a speed of approximately 60 miles per hour (vertical speed component). (There has been no evidence that the casings are distorted by impacting the ocean since the impact loads are low and the cases are still assembled at this point.) The parachutes and boosters are retrieved by divers at sea and both Solid Rocket Boosters are towed back to the Cape by ships. They are towed into a special dock, lifted in slings, conveyed to a wash rack and completely washed down to remove salt water. The casings are made of high carbon steel which is very susceptible to corrosion. The casings are then disassembled, given a visual inspection, and shipped back to Utah for refurbishment. At a plant in Clearfield they are further cleaned and "shot with glass beads" to assure that all foreign contaminants have been removed. The cases are then inspected to determine the dimensions of tang and clevis and for cracking. Inspection for cracks is performed by using a magnetic flux technique. The procedure calls for a test whereby cracks must be of such a minimum size as to be able to withstand four more flight uses without failure. The casings are then subjected to a hydroburst test where they are pressure tested with a mixture of oil and water, to assure sufficient strength to withstand propellant pressure during flight. The hydroburst test is conducted at 1.1 times the maximum expected operating pressure (MEOP). This

gives assurance that the strength can accommodate 10 percent more load than the casings will experience in use. There was no indication that there had been any damage to the casings from Flight 51-C.

### C. EXTERNAL TANK

#### *Issue*

The External Tank was obviously involved in the accident. Was that involvement a cause or an effect?

#### *Findings*

1. The Committee adopts the "Finding" of the Rogers Commission that: "A review of the External Tank's construction records, acceptance testing, pre-launch and flight data and recovered hardware, does not support anything relating to the External Tank which caused or contributed to the cause of the accident."<sup>35</sup>

2. The External Tank ruptured under the forces of a failed Solid Rocket Booster motor. These forces were far outside of any possible design considerations that could have been applied to the External Tank.<sup>36</sup>

#### *Discussion*

The 154 foot long, 27 foot diameter external disposable fuel tank contains the liquid oxygen and liquid hydrogen used by the Space Shuttle's three main engines. Structurally, the External Tank (ET) serves as the keel, or backbone, of the Space Transportation System. The two Solid Rocket Boosters are attached to the External Tank near the front and rear of the ET. The Space Shuttle Orbiter is also attached to the ET at one forward, and two aft attachment points.

The Committee was interested in the findings of the Rogers Commission concerning the External Tank because it was obvious to all that the External Tank was directly involved in the accident.

The Rogers Commission investigated five potential faults or failures of the External Tank which could have contributed to the accident.<sup>37</sup>

They are:

- Premature detonation of the External Tank Range Safety System;
- A structural flaw in the tank;
- Damage at lift-off;
- Structural overload;
- Overheating.

The Committee is satisfied that the Range Safety System on the External Tank did not cause the STS 51-L accident because:<sup>38</sup>

- There is no flight data to support premature detonation of the ET range safety package;

<sup>35</sup> Rogers Commission Report, Volume I, p. 42.

<sup>36</sup> Ibid., Volume II, p. L-23.

<sup>37</sup> Ibid., Volume I, p. 41.

<sup>38</sup> Ibid., Volume II, p. L-16.

The photographic evidence does not support premature detonation;

Most of the explosive charges included in the ET Range Safety System were recovered with the ET wreckage, undetonated.

The Committee affirms the Rogers Commission finding that there is no data to support structural faults which might have propagated to a size which could have caused catastrophic failure of the External Tank.<sup>39</sup>

The evidence from the Ice Team examination, and photo analysis and television monitoring of the launch give no indication whatsoever that there was any damage to the External Tank during launch and lift-off.

The examination of all flight data indicates that the maximum structural load on the External Tank on STS 51-L was less than 80 percent of the allowable design load from launch until the final explosion.<sup>40</sup>

The Committee also affirms the Rogers Commission finding that the evidence does not support any theory of independent overheating of the External Tank as a cause of the accident.<sup>41</sup>

The failed joint in the Solid Rocket Motor permitted the burning solid propellant gases to escape in the direction of the aft External Tank attachment strut. Temperatures and velocity of these gases caused a rapid erosion and deterioration of the aft strut to the point where it failed structurally under turbulence and maneuvering loads. There were no deficiencies in the design of the external strut. However, the strut was not designed to withstand the "blowtorch" effect of the propellant hot gas stream. During its investigation, the Committee staff visited Martin Marietta's External Tank assembly plant in Louisiana. An issue raised during this visit was whether or not the strut could be relocated such that in the event of another joint failure in that vicinity, the strut would not be damaged. It was learned that relocating the aft strut created more problems that it solved. Furthermore, it was also learned that the gas stream would have almost instantly cut through the insulation on the External Tank and destroyed it anyway. After the failure of the aft strut, the flame continued to bear on the bottom of the External Tank, breaching that tank at the joint of the aft dome. This caused the liquid hydrogen to escape from the tank. Once the flame had penetrated the tank at the weld of the aft dome the failure of that weld spread rapidly and completely around the tank's diameter severing the dome from the rest of the tank. The burning hydrogen ignited by the flame then caused the External Tank to act much like a rocket and created an upward thrust. The right Solid Rocket Booster without the attachment strut to the External Tank, rotated around its long axis.<sup>41a</sup> In so doing, it may have

<sup>39</sup> Ibid., Volume I, p. 42.

<sup>40</sup> Ibid.

<sup>41</sup> Ibid.

<sup>41a</sup> It should be noted that the right Solid Rocket Booster did not swing outward at the bottom and cause the nose of the booster to collide with the External Tank as had originally been thought. For this to have happened, the right Solid Rocket Booster would have extended outward at the bottom at a wide angle that is not supported by any of the photographic or telemetric evidence.

jammed the upper Solid Rocket Booster to the External Tank attachment structure and caused it to fail. That structure is located on a large cross beam in the intertank which in turn possibly damaged the cross beam. The other distinct possibility is that the burning hydrogen forced the External Tank upward and caused the cross beam to be damaged and at the same time, caused a rupture of the oxygen tank. With the massive release of energy from the burning of the hydrogen/oxygen, the Shuttle system completely broke apart.

NASA's Accident Analysis Team determined that the Orbiter was destroyed by aerodynamic forces beyond design limits, not by the actual explosion of the External Tank. The report stated,

All fractures and material failures examined on the Orbiter, with the exception of the SSME's, were the result of overload forces and they exhibited no evidence of internal burn damage or exposure to explosive forces.<sup>41b</sup>

#### D. CREW SURVIVAL

##### *Issue*

Was the accident of STS 51-L on January 28, 1986, survivable?

##### *Findings*

In the case of the tragic loss of the Space Shuttle Challenger and her crew on January 28, 1986, the Committee is convinced that the accident was not survivable.

##### *Discussion*

During the first two minutes and eight seconds of Shuttle flight the two Solid Rocket Boosters provide approximately three million pounds of thrust. That thrust is transferred to the External Tank through the forward Solid Rocket Booster/External Tank attachment structure. The thrust is then transferred to the Orbiter through the External Tank. While NASA has established a "Fast-separation sequence" to allow the Orbiter to separate from the External Tank and Solid Rocket Boosters, the engineering analysis indicates that if separation was attempted while the Solid Rocket Boosters were still firing, the Orbiter would "hang-up" on the forward attachment structure. This would lead to a violent maneuver which would greatly exceed maximum aerodynamic loads on the Orbiter with resulting structural failure and loss of Shuttle and crew.

During the course of hearings before the Committee on the accident the question of survivability was frequently raised. The Committee accepts the view of Captain Robert L. Crippen, who informed the Rogers Commission:

I've said this before publicly, and I'll say it again, I don't think I know of an escape system that would have saved the crew from the particular incident that we just went

<sup>41b</sup> NASA, Leslie Kampschorr, "Space Transportation System Mission 51-L Structural Reconstruction and Evaluation Report," Enclosure 8 in "STS 51-L Data and Design Analysis Task Force Search, Recovery and Reconstruction Team Report," Volume IV, Rev. A, May 8, 1986, p. 3.

through. I don't think it is possible to build such a system.<sup>42</sup>

Specifically, the Committee finds that the Space Shuttle System was not designed to survive a failure of the Solid Rocket Boosters during the first 2 minutes of flight; that is, until all the solid rocket propellant fuel has been expended. There were no corrective actions that could have been taken once the boosters ignited. The Challenger was not equipped with any means for separation during the first two minutes of flight. In addition, the crew did not have any means to escape from the Orbiter during this first-stage ascent. Neither the Mission Control Team nor the 51-L crew had any warning of impending disaster. Even if there had been warning, there were no actions that could have been taken to save the crew.<sup>43</sup> (The issue of launch abort and crew escape is discussed in Section VI.A.2.d.)

Joseph P. Kerwin of NASA's Johnson Space Center summarized the circumstances in a memo to Rear Admiral Richard H. Truly, Associate Administrator for Space Flight. The undated memo read as follows:

DEAR ADMIRAL TRULY: The search for wreckage of the Challenger crew cabin has been completed. A team of engineers and scientists has analyzed the wreckage and all other available evidence in an attempt to determine the cause of death of the Challenger crew. This letter is to report to you the results of this effort.

The findings are inconclusive. The impact of the crew compartment with the ocean surface was so violent that evidence of damage occurring in the seconds which followed the explosion was masked. Our final conclusions are:

The cause of death of the Challenger astronauts cannot be positively determined;

The forces to which the crew were exposed during Orbiter breakup were probably not sufficient to cause death or serious injury; and

The crew possibly, but not certainly, lost consciousness in the seconds following Orbiter breakup due to in-flight loss of crew module pressure.

Our inspection and analyses revealed certain facts which support the above conclusions, and these are related below:

The forces on the Orbiter at breakup were probably too low to cause death or serious injury to the crew but were sufficient to separate the crew compartment from the forward fuselage, cargo bay, nose cone, and forward reaction control compartment. The forces applied to the Orbiter to cause such destruction clearly exceed its design limits.

The data available to estimate the magnitude and direction of these forces included ground photographs and measurements from onboard accelerometers, which were lost two-tenths of a second after vehicle breakup.

<sup>42</sup> Rogers Commission Report, Volume V. p. 1431.

<sup>43</sup> *Ibid.*, Volume I, p. 180.

Two independent assessments of these data produced very similar estimates. The largest acceleration pulse occurred as the Orbiter forward fuselage separated and was rapidly pushed away from the External Tank. It then pitched, nose-down and was decelerated rapidly by aerodynamic forces. There are uncertainties in our analysis; the actual breakup is not visible on photographs because the Orbiter was hidden by the gaseous cloud surrounding the External Tank. The range of most probable maximum accelerations is from 12 to 20 G's in the vertical axis. These accelerations were quite brief. In two seconds, they were below four G's; in less than ten seconds, the crew compartment was essentially in free fall. Medical analysis indicates that these accelerations are survivable, and that the probability of major injury to crew members is low.

After vehicle breakup, the crew compartment continued its upward trajectory, peaking at an altitude of 65,000 feet approximately 25 seconds after breakup. It then descended striking the ocean surface about two minutes and forty-five seconds after breakup at a velocity of about 207 miles per hour. The forces imposed by this impact approximated 200 G's, far in excess of the structural limits of the crew compartment or crew survivability levels.

The separation of the crew compartment deprived the crew of Orbiter-supplied oxygen, except for a few seconds supply in the lines. Each crew member's helmet was also connected to a personal egress air pack (PEAP) containing an emergency supply of breathing air (not oxygen) for ground egress emergencies, which must be manually activated to be available. Four PEAP's were recovered, and there is evidence that three had been activated. The nonactivated PEAP was identified as the Commander's, one of the others as the Pilot's, and the remaining ones could not be associated with any crewmember. The evidence indicates that the PEAP's were not activated due to water impact.

It is possible, but not certain, that the crew lost consciousness due to an in-flight loss of crew module pressure. Data to support this is:

The accident happened at 48,000 feet, and the crew cabin was at that altitude or higher for almost a minute. At that altitude, without an oxygen supply, loss of cabin pressure would have caused rapid loss of consciousness and it would not have been regained before water impact.

PEAP activation could have been an instinctive response to unexpected loss of cabin pressure.

If a leak developed in the crew compartment as a result of structural damage during or after breakup (even if the PEAP's had been activated), the breathing air available would not have prevented rapid loss of consciousness.

The crew seats and restraint harnesses showed patterns of failure which demonstrates that all the seats were in place and occupied at water impact with all harnesses locked. This would likely be the case had rapid loss of consciousness occurred, but it does not constitute proof.

Much of our effort was expended attempting to determine whether a loss of cabin pressure occurred. We examined the wreckage

carefully, including the crew module attach points to the fuselage, the crew seats, the pressure shell, the flight deck and middeck floors, and feedthroughs for electrical and plumbing connections. The windows were examined and fragments of glass analyzed chemically and microscopically. Some items of equipment stowed in lockers showed damage that might have occurred due to compression; we experimentally decompressed similar items without conclusive results.

Impact damage to the windows was so extreme that the presence or absence of in-flight breakage could not be determined. The estimated breakup forces would not in themselves have broken the windows. A broken window due to flying debris remains a possibility; there was a piece of debris imbedded in the frame between two of the forward windows. We could not positively identify the origin of the debris or establish whether the event occurred in flight or at water impact. The same statement is true of the other crew compartment structure. Impact damage was so severe that no positive evidence for or against in-flight pressure loss could be found.

Finally, the skilled and dedicated efforts of the team from the Armed Forces Institute of Pathology, and their expert consultants, could not determine whether in-flight lack of oxygen occurred, nor could they determine the cause of death.<sup>44</sup>

#### E. SABOTAGE

##### *Issue*

Could the accident have been caused by sabotage, terrorism, or foreign covert action?

##### *Finding*

The Committee is convinced that there is no evidence to support sabotage, terrorism or foreign covert action in the loss of the Challenger.

##### *Discussion*

The Committee carefully reviewed all of the evidence, classified and unclassified, to ensure that there was no sabotage associated with the loss of the Space Shuttle Challenger.

Committee staff met with the Director of Safety, Reliability and Quality Assurance, and the Director of Protective Services and his staff to review the National Resource Protection Plan for the Kennedy Space Center. The Committee is concerned with the vulnerability of the Space Transportation System and endorses the efforts being taken by NASA to provide adequate protection to all elements of the system.

#### F. ADDITIONAL AVENUES OF INVESTIGATION

##### *Issue*

Could the accident have been caused by some failure other than failure of the joint between the casings?

---

<sup>44</sup> This memo was part of a package release, NASA, 86-100, draft, July 21, 1986.

### *Finding*

As of September 15, 1986, the Committee has not found any credible evidence to support any cause of the Challenger accident, other than the failure of the aft casings joint in the right-hand Solid Rocket Booster. Nor has there been any substantial evidence of a secondary or parallel failure on Flight 51-L.

### *Discussion*

After the accident, the Committee waited until the Rogers Commission completed its work in order not to interfere with the progress being made by the Commission appointed by the President. By the time that work was completed the preponderance of evidence clearly pointed to a failure in the field joint of the right Solid Rocket Booster. However, the Committee was obligated to explore other possibilities which could have led to the same type of failure. Among these possibilities were the following: a failure of the propellant, a structural flaw in the steel casing, and separation of the NBR insulation from the casing. In addition, the Committee was contacted by and sought additional testimony from private citizens who offered their concerns and hypotheses pertaining to the cause of the Challenger accident. These included the following: either a main engine fire or a fire in the main engine compartment of the Orbiter, inadvertent firing of an OMS engine, inadvertent firing of one or more thrusters on the Orbiter, overloading of the aft field joint due to excessive "moment" developed in transit of the Shuttle from the VAB to the launch pad and the use of four separate propellant casings instead of one large casing without field joints.

#### 1. Main Engine Fire

The photographs in Volume I of the Rogers Commission report on pages 26 and 27 indicate a bright spot in the vicinity of the main engine compartment. Photographic evidence is customarily taken to be accurate. In this case, however, it must be realized that the photographs were taken from roughly three miles away and that they were enhanced by computer methods. Computer enhancement has the ability to highlight bright objects and subdue dull ones. In this way, the photographs become distorted, that is, the difference between light and dark becomes unrealistically pronounced. The bright spot in the photographs does, in fact, look like a flame. The second consideration is that the orientation between the Orbiter and the ground where the cameras were is difficult to visualize and leads to erroneous conclusions. During flight the main engines are monitored continuously for changes in pump speed, temperature and pressure. There was no indication whatsoever of a malfunction with the main engines. A fire in the main engine compartment outside of the engines is not credible because of the lack of combustible material to support a fire of any appreciable magnitude. The exception would be a hydrogen leak. But, that was not supported by telemetry data. In addition, NASA has submitted photographs to the Committee from four past successful launches which show the same bright spots. The Committee, therefore, has rejected this as a cause of the accident or as an independent problem.



## 2. Independent Firing of the OMS Engine or Orbiter Thrusters

The theory that either the OMS engines or the Orbiter thrusters were inadvertently activated and fired is also based on the same photographs stated previously. Those photographs show a bright spot in the same general area where these engines and thrusters are. The Committee has received photographs from Flights 41-G, 61-A, 61-13, and 61-C, all of which show similar "bright spots" in the same location as those seen on Flight 51-L. The Committee is still evaluating the possibility of a second failure in this regard and has requested additional telemetry data from Flight 51-L. Had the thrusters been firing, however, it would have had little impact on the launch of the Challenger. The thrust from these tiny engines is insignificant compared to the thrust from the two Solid Rocket Boosters and the main engines. The inadvertent activation of the OMS engine has been ruled out on the basis of telemetry data received from NASA. NASA has stated that the bright spot seen in the photographs is a reflection from the plume of the Solid Rocket Booster motors. Neither of these possibilities contributed to the Challenger accident.

## 3. Overloading of the Joint

It is true that in transit from the VAB to the launch pad, the Shuttle system, standing erect on the launch platform and being carried by a crawler, does experience a left-hand turn. At that time, because of the configuration of the Shuttle system, an additional moment, that is force times a distance, is transferred to the field joints including the aft joint on the right-hand Solid Rocket Booster that failed. However, this moment exerts a force which is only 10 percent of the force that the joint receives during other phases of the launch operations. The Committee concluded that this had no impact on the Challenger accident.

## 4. Insulation Debonding

The Committee investigated the possibility of separation of the insulation from the inside of the motor casings as a potential cause of the Flight 51-L accident. Had the insulation broken loose from the casing, there would have to have been a condition which would have permitted the burning propellant gases to get between the insulation and the casing. Furthermore, there would have to be a continuous gas flow at that point for the propellant gas to transfer a sufficient amount of heat to the casing to cause a failure. This would require an extremely large debonding of the insulation which has never been seen on any Shuttle flight when the Solid Rocket Motors were returned and disassembled for use later. When the Shuttle motors were inspected after usage, what remained of the insulation has always been in place with little damage. A debonding accident would have had to provide tremendous amounts of heat and again would have required a very high flow of the gas into the area where the debonding occurred. That flow of gas would have to be continuous and there is no rationale for envisioning how that could happen. In the case of the Shuttle Solid Rocket Motor design, the pressure acts to maintain the bond between the insulation and the casing, not to remove it. In the absence of these re-

quirements the Committee found that debonding of the insulation was not a cause of the accident.

#### 5. Crack in the Propellant

The Committee investigated whether or not a crack in the propellant could have contributed to loss of the Challenger. A crack in the propellant would have increased the burning surface of the propellant after ignition. This increase in the surface would have resulted in an increase in the thrust from the right Solid Rocket Motor. There was no evidence during the flight of 51-L of a greater thrust in the right Solid Rocket Motor. In addition, a propellant failure would have been more explosive in nature and would not have been observed as one continuous gas flame in a localized area. Consequently, it was concluded that a propellant failure did not contribute to the cause of the accident.

#### 6. Crack in Motor Casing

The Committee was concerned that a crack in the rocket motor casings might have caused the accident if it was located in the same general area where the smoke and flame was observed during launch. All of the casings used on Flight 51-L were hydroproofed at 1.1 maximum expected operating pressure. Had there been a significant crack in the casing it would have failed the hydroproof test. However, it could be argued that a crack developed between the test and the time the Solid Rocket Motor segments were assembled at the Kennedy Space Center. The failure of cracks under the pressures, such as those contained within the Solid Rocket Motors, would have been a catastrophic failure. The casings would have failed instantly at ignition because cracks in high carbon steel would propagate at a rate near the speed of sound. This is inconsistent with the smoke seen during the early part of the launch, and the lack of smoke or flame up until 58 seconds into the launch. It is also inconsistent with the pieces of the rocket motor casings which were recovered from the ocean which clearly show the abrasion of the hot rocket propellant gases. Consequently, a crack in the casing was ruled out as a contributing cause of the accident.

#### 7. Joint putty temporarily holds and then releases full motor pressure

During the post-accident tests conducted by NASA and Thiokol, it was learned that the performance of the putty used in the joint can be quite variable. In some instances, including temperatures as warm as 75°F, the joint putty can hold back the full operating pressure inside the motor without transferring any of this pressure to the O-rings.<sup>45</sup> In this circumstance, the O-rings will not "seat" and, as the joint "rotates" due to the pressure build-up within the motor, contact can be lost between the O-rings and the metal surfaces they are meant to seal.<sup>46</sup> If the putty were then to release

---

<sup>45</sup> Rogers Commission Report, Volume I, p. 64.

<sup>46</sup> NASA, briefings from staff.

high pressure gases into the joint, these gases could "blow-by" the O-rings, thus causing the joint to fail. This scenario is not a likely failure mode for STS 51-L, because it would produce a leak across a broad area of the joint rather than a small localized leak as observed in the Challenger accident.



## VI. DISCUSSION OF CRITICAL ISSUES

### A. TECHNICAL ISSUES

#### 1. HARDWARE DEVELOPMENT AND PRODUCTION

##### a. Problems in Hardware Certification

###### *Issue 1*

Having all elements of Space Shuttle flight hardware been adequately certified?

###### *Findings*

1. The overall design and certification processes prescribed by NASA for each major element of Space Shuttle flight hardware are very comprehensive.

2. Prior to the STS 51-L accident, in spite of the comprehensive nature of NASA's prescribed design and certification processes, insufficient testing had been conducted to permit an adequate understanding by either Morton-Thiokol or NASA regarding the actual functioning of the Solid Rocket Motor joint. Also, the Solid Rocket Motor had not been adequately certified to meet the natural and induced environmental conditions that are stated in NASA's design standards. The issue of whether or not standards were adequate is discussed in Section VII.

3. The deficiencies in Solid Rocket Motor testing and certification persisted in spite of many reviews of the program by panels of experts: (1) within the manufacturer; (2) within NASA; and (3) from independent, outside groups.

4. These deficiencies in testing and certification of one major element of the Space Shuttle system raise the possibility that other elements of flight hardware (or other subelements of the Solid Rocket Motor) could have similar deficiencies.

5. If NASA is unable to explain why the deficiencies in Solid Rocket Motor testing and certification went undetected by the existing comprehensive set of processes and procedures, the agency will not be able to protect against a similar break-down in its system of checks and balances in the future.

###### *Recommendations*

1. NASA should devote more attention to determining why the deficiencies in Solid Rocket Motor testing and certification went undetected, so that appropriate action can be taken to uncover latent problems in existing hardware and to prevent similar problems in future development programs.

2. NASA and its contractors should thoroughly reassess the adequacy of all of the testing and certification that has been conducted

to date on each element of Space Shuttle flight hardware. Where deficiencies are found, they must be corrected.

### *Discussion*

In background briefings for the Committee staff prior to the start of the hearings, NASA described the system of formal reviews that were employed to scrutinize the design and certification of each element of flight hardware.

The review process began with a System Requirements Review in the early 1970's. About 18 months later, each hardware element went through a Preliminary Design Review (PDR). This review was conducted when about 10 percent of the engineering drawings were complete and resulted in approval for the hardware to move into the final design stage. The Critical Design Review (CDR) was held when about 90 percent of the engineering drawings were complete and resulted in an authorization to carry the manufacturing process through to completion. After the end of a detailed test and certification program, NASA conducted a Design Certification Review (DCR) to ensure that all tests and certification results were consistent with specified design requirements and standards.

Because of the extreme complexity of the Orbiter, a series of Configuration Acceptance Reviews (CARs) was also conducted in addition to the standard process of reviews described above. The Phase I CAR was a verification review to ensure that the Orbiter was ready to begin test. Prior to the start of the Orbiter combined system test, several additional incremental test reviews were also conducted. The Phase III CAR was the verification review that resulted in final acceptance of the vehicle for delivery from the manufacturer to NASA.

In Appendix K in Volume II of the Rogers Commission Report, the Development and Production Team discusses in further detail the design and certification processes that were used by each prime contractor. For example, this appendix indicates that Rockwell used a total of 17 design review teams (some divided into as many as 17 subteams) to oversee the design and production work on the Orbiter. The appendix also describes the requirement verification system used by Thiokol for the Solid Rocket Motor as a "closed-loop" system intended to track *each* specification requirement. The system specified the method of verification (analysis, inspection, test, etc.) that was to be used for each program phase (development, acceptance, prelaunch, etc.), along with all applicable requirements of the verification plan. These were tracked through the test plans and reports and then culminated in the issuance of a formal "certificate of qualification".<sup>1</sup>

In addition to this comprehensive system of oversight and review by each prime contractor and each NASA field center responsible for monitoring the work of those contractors, detailed outside reviews of the design and testing programs for each major element of flight hardware also occurred. For example, the Aerospace Safety Advisory Panel regularly reviewed the safety aspects of Space Shuttle flight hardware and annually reported their concerns to

<sup>1</sup> Rogers Commission Report, Volume II, pp. K-12 and K-28.

the NASA Administrator.<sup>2</sup> As another example, NASA Headquarters in 1980 created a Space Shuttle Verification/Certification Committee to thoroughly study the flight worthiness of the entire Shuttle system.<sup>3</sup> This independent committee was chaired by Dr. Walt Williams, NASA's Chief Engineer, and was comprised of recognized experts drawn from the military, private industry, and academia. There was also additional reviews such as a study of the Space Shuttle Main Engine conducted by Professor Gene Covert of MIT.<sup>4</sup>

Finally, before the first flight of the Space Shuttle in 1981, NASA had each contractor and each field center carefully review all of the requirement specifications and certification tests for their flight hardware to ensure that all contract end-item requirements had been adequately certified. Upon determining that all certification requirements had been satisfied, each NASA project and technical manager was required to sign a Verification Completion Notice (a copy of which is contained in Appendix VI-A of this report). This entire process was then duplicated prior to the first "operational" flight of the Space Shuttle (i.e., STS-5 in 1982). This latter process also culminated in each NASA project and technical manager signing a second Verification Completion Notice (a copy of which is contained in Appendix VI-A of this report).

Given this comprehensive system of reviews, it is difficult to understand how major inadequacies in design and certification for any element of flight hardware could have gone unnoticed. But it is exactly what happened for the Solid Rocket Motor. Specifically, the Commission concluded that:

The joint test and certification program was inadequate.

And,

Prior to the accident, neither NASA nor Thiokol fully understood the mechanism by which the joint sealing action took place.<sup>5</sup>

In addition, the Development and Production Team concluded that:

Prior to the STS 51-L accident, there was a lack of understanding on the part of MTI [Morton Thiokol Inc.] and NASA of the joint operation as designed.

And,

JSC 07700, Volume X [the NASA master requirements document for the Space Shuttle program], clearly states the natural and induced environments to which the SRM [Solid Rocket Motor] is to be designed and verified. The field joints . . . were not qualification tested to the full range of the contractually required environments. This led to a lack of complete understanding of the joint design limits.<sup>6</sup>

<sup>2</sup> Ibid., Volume I, pp. 160-161.

<sup>3</sup> Ibid., pp. 124-125.

<sup>4</sup> Ibid., Volume II, p. K-24.

<sup>5</sup> Ibid., Volume I, p. 148.

<sup>6</sup> Ibid., Volume II, p. K-30.

Relative to this last point, the NASA requirement documents state that: "The Shuttle Flight Vehicle design shall satisfy the natural environmental design requirements . . .", including air temperature extremes of 20°F to 103°F at "Ferry Sites" and 31°F to 99°F for "Vertical Flight". Also, the requirement documents state that: "Each element of the Shuttle Flight Vehicle shall be capable of withstanding the induced environments imposed during transportation, ground operations, handling and flight operations . . .", including induced Solid Rocket Booster surface temperatures as low as 25°F and induced temperatures as low as 21°F at the point where the aft strut attaches the Solid Rocket Boosters to the External Tank. (Excerpts documenting these temperature requirements are contained in a briefing given by NASA to Joseph Sutter of the Rogers Commission on May 19, 1986, which is reproduced in Appendix VI-A-4 of this report.)

Of principal concern to the Committee is the fact that none of the extensive systems of checks and balances within the Space Shuttle program discovered the lack of adequate testing and certification of the Solid Rocket Motor. This failure of the management and review system indicates to the Committee that other elements of Shuttle flight hardware or other subelements of the Solid Rocket Motor may also be inadequately understood or certified. This will obviously require NASA and its contractors to conduct a careful review of all the testing and certification efforts that have been conducted to date for each element of Space Shuttle flight hardware.

A parallel concern of the Committee is that NASA does not yet know how or why this break-down occurred in this comprehensive system of reviews, checks, and balances. Without such an understanding, the teams that will now be conducting the required reviews of each element of flight hardware will be somewhat disadvantaged because they cannot be certain that they are "asking the right questions" or "looking for the right things." Further, without an understanding of how and why the existing management and control system broke down, NASA will not be able to make the necessary managerial and procedural changes required to be confident that this problem will not reoccur in the future.

### *Issue 2*

Does the Space Shuttle Main Engine have adequate operating margins, and is the "fleet leader" concept adequate to ensure safe operation?

### *Findings*

1. The Space Shuttle Main Engine is an impressive technological achievement. However, it also is one of the higher risk elements of the Space Shuttle system. Anomalous component performance or premature engine shutdown could prove catastrophic to the Space Shuttle and its crew.

2. Some NASA officials familiar with the Space Shuttle Main Engine believe that it should be operated at a throttle setting of 109 percent only in an emergency; others believe the engine could be safely operated at 109 percent on a routine basis.



3. It is widely accepted that the Space Shuttle Main Engine would be safer if its operating margins (for temperature, pressure, operating time, etc.) were increased.

4. The Committee agrees with the sense of Dr. Feynman's concerns with respect to NASA's current, "fleet leader" concept for certifying Space Shuttle Main Engine components, such as high pressure turbopumps, for flight.

5. On a case by case basis, NASA regularly violates its own certification requirements by permitting individual engine components to be used for flight even though they have accumulated an operating time in excess of 50 percent of the two fleet leaders (i.e., in violation of the "2X" rule).

#### *Recommendations*

1. NASA should continue its active development program for the Space Shuttle Main Engine. The program should be focused more on increasing operating margins.

2. Because of the safety concerns raised by some knowledgeable officials, NASA should give serious consideration to restricting use of the 109 percent engine throttle setting to emergency situations only. If NASA decides that it needs to use the 109 percent throttle setting for other than emergency situations, the space agency should take whatever actions are required to ensure that adequate margins are present to maintain safety.

3. NASA should closely scrutinize each of the concerns raised by Dr. Feynman regarding the agency's "fleet leader" concept for certifying Space Shuttle Main Engine components. The agency should also closely reassess its practice of selectively violating its "2X" rule for some Main Engine flight hardware elements.

#### *Discussion*

The Space Shuttle Main Engine is, very appropriately, described by the Development and Production Team as a "high technology, high power density, state-of-the-art rocket engine."<sup>7</sup> Indeed, the Space Shuttle Main Engine represents a major increase in operating performance over that provided by any other available rocket motor. In his paper Dr. Feynman notes that the Main Engine "is built at the edge of, or outside of, previous engineering experience."<sup>8</sup> The Development and Production Team also observed that the Space Shuttle Main Engine is "a very complex and high risk element of the Space Shuttle system."<sup>9</sup>

It is this last observation that is of more concern here. Specifically, if the Space Shuttle Main Engine were to experience a major problem in flight, the results could be catastrophic. Even premature engine shutdown could prove fatal during certain segments of flight because it would mean that the Orbiter would have to ditch at sea—a maneuver that the Rogers Commission concluded would probably be non-survivable.<sup>10</sup>

<sup>7</sup> Rogers Commission Report, Volume II, p. K-3.

<sup>8</sup> *Ibid.*, p. F-2.

<sup>9</sup> *Ibid.*, p. K-3.

<sup>10</sup> *Ibid.*, Volume I, p. 182.

Therefore, the key question is: how safe is the Space Shuttle Main Engine? An informal review of failures that have occurred during ground testing over the past five years was reported to the Committee staff.<sup>11</sup> It concluded that five of these failures would probably have been catastrophic if they had occurred in flight.<sup>12</sup> It is also of note that each of these failures occurred at an engine thrust setting of 109 percent or greater. However, closer examination of the cause for each failure indicates that most were the result of: poorly installed test instrumentation (engine 2208); an improperly tested "fix" to an engineering problem (engine 2013); the use of "deactivated" components because no others were available (engine 0204); or the existence of a phenomenon that cannot recur because of the adoption of a new safety "red line" in current flight engines (engine 0108). The failure of engine 2308, on the other hand, did uncover a life limit on current engine hardware. That particular engine had accumulated about 20,000 seconds of operation (the equivalent of 40 Space Shuttle missions) in the component which failed (the main combustion chamber). Further, this engine had reportedly logged a significant amount of operating time at a power level of 109 percent.

However, the question of engine safety still remains. The majority of present and past Space Shuttle Main Engine program officials who briefed the Committee staff were personally uneasy at the thought of operating the Main Engine at a thrust setting of 109 percent in anything other than an emergency situation. Specifically, in certain emergency or abort situations, the throttle must be advanced to 109 percent to either reach orbit or to successfully return to the launch site. Under these circumstances, the risks of not using the 109 percent throttle setting (and having to ditch the Orbiter at sea) would obviously be greater than the risks of using that throttle setting. These officials also noted that, at the outset of the Main Engine development program, the 109 percent power setting was referred to as the "Emergency Power Level". As the payload lift performance of the Space Shuttle became increasingly marginal, however, the 109 percent setting was redesignated as the "Full Power Level." Subsequently, several engines were ground tested at the 109 percent power setting for a sufficient duration to certify use of that power setting in normal launch operations.

In addition to Space Shuttle Main Engine program officials at NASA, others have expressed concern with using the 109 percent throttle setting. For example, the Aerospace Safety Advisory Panel voiced concern that "each time NASA flies at 109% we are really pushing the capability of the engine".<sup>13</sup> In his testimony before the Committee, Mr. George Jeffs, President of Rockwell International (manufacturer of the engine) conceded that:

. . . we don't have a lot of margin at 109 percent. . . . To be comfortable . . . we would recommend that we go to a

---

<sup>11</sup> Discussions with personnel from Rocketdyne, Pratt & Whitney, and Aerojet General, August, 1986.

<sup>12</sup> These include the destructive failures of engine 0204 in September 1981; engine 2013 in April 1982; engine 2208 in August 1982; engine 0108 in February 1984; and engine 2308 in March 1985.

<sup>13</sup> Discussion with Aerospace Safety Advisory Panel, May, 1986.

larger throat . . . and that we also add to that the dual manifold gas system. . . ."<sup>14</sup>

All observers agree that the "wear and tear" on an engine operating at 109 percent is substantially greater than when it operates at the more standard 100 to 104 percent throttle settings. However, some NASA officials believe that the successful completion of a traditional certification program involving two engines operating at 109 percent thrust levels is adequate justification for use of the 109 percent power setting for standard missions involving heavy payloads. Other officials, on the other hand, continue to believe that this power setting should be used only in emergencies. If this latter view is adopted, it would mean that the heaviest payloads now planned for launch by the Space Shuttle would have to be moved to expendable launch vehicles. The Committee is not now in a position to accurately predict the programmatic ramifications of such a decision, but the recent national commitment to an enhanced expendable launch vehicle fleet could possibly minimize the negative impacts of a decision to restrict Space Shuttle Main Engine thrust levels to no more than 104 percent.

Though there is substantial disagreement whether or not the Space Shuttle Main Engine should be used routinely at a thrust setting of 109 percent, there is little or no disagreement that the Main Engine would be safer if its operating margins (for temperature, pressure, operating time, etc.) were increased. Indeed, the Development and Production Team noted in its report that one of the formal actions being taken by Rocketdyne in response to the STS 51-L accident is the creation of a "Margin Improvement Board."<sup>15</sup> This board will review and suggest appropriate actions on all recommendations for increased engine operating margins.

Another concern that has been raised regarding the certification of the Space Shuttle Main Engine relates to NASA's use of the "fleet leader" concept. NASA's basic engine certification guidelines require that all components be tested on the ground in two engines for a period of time at least twice as long as the time that those components will accumulate in flight. For example, before turbopumps can be used for four successive flights, the turbopumps in two ground test engines must be tested for the equivalent time that would be required to accomplish eight successive flights. Dr. Feynman cites several problems with this approach. These include:

The question of what constitutes an "unsuccessful" test? To the Federal Aviation Administration, a cracked turbine blade would constitute a failed test. To NASA, on the other hand, a turbine blade would not be considered to have "failed" until it actually broke in two.<sup>16</sup>

<sup>14</sup> Hearings before the House Science and Technology Committee, "Investigation of the Space Shuttle Challenger Accident," 99th Cong., 2nd Sess., Transcript, July 15, 1986, p. 13. (Hereafter referred to as Cmte Hgs).

<sup>15</sup> Rogers Commission Report, Volume II, p. K-27.

<sup>16</sup> After further investigation, the Committee has learned that some qualifying remarks are required for Dr. Feynman's characterization of the FAA engine qualification procedures to be totally accurate. The FAA does not permit cracks in what it calls "critical" engine components. However, cracks located at, or above, the base of a turbine blade are not considered critical by the FAA because: (1) commercial jet engines possess adequate internal shielding to contain any

Continued

The question of whether two "fleet leader" engines represent a better indication of component operating life than a third engine which fails in a lesser time? In other words, should the operating time limits for flight hardware be set at one-half that of the two fleet-leader engines or one-half that of the shortest-lived components?

When a defect is found in a fleet leader engine and a component must be replaced, what engine running time should be used for calculating permissible flight hardware operating times for that component using the "2X" rule: (1) the accumulated operating time up to the start of the final test; (2) the accumulated time as of the end of the final test; or (3) some length of time in between these two extremes?<sup>17</sup>

In the staff review prior to the Committee hearings, NASA officials also noted that the agency frequently violates its "2X" rule for engine flight hardware—permitting components to be used in a particular mission that have not been tested on the ground for twice as long as their intended use in flight. However, these officials noted that this was only done on a "case by case basis" and only for those components that are considered to be highly reliable.

Possibly the most disturbing observation regarding the Space Shuttle Main Engine made by Dr. Feynman in his report is his assertion that: "the Flight Readiness Reviews and certification rules show a deterioration for some of the problems of the Space Shuttle Main Engine that is closely analogous to the deterioration seen in the rules for the Solid Rocket Boosters." If true, this assertion is obviously quite ominous.<sup>18</sup>

#### b. Recurrent Hardware Problems

##### *Issue 1*

What resolutions of inadequacies revealed in the landing gear, tires, wheels, brakes, and nose wheel steering of the landing and deceleration system are required?

##### *Findings*

1. The Orbiter landing gear, tires, wheels, brakes, and nose wheel steering, as a system, is experimental, designed to criteria outside any other experience, and uses unique combinations of materials. The original design performance specifications for speed and landing weights are routinely exceeded. The original design did not consider asymmetrical braking for cross wind steering as the normal case although it has become standard practice. Stresses which were not taken into account in the design have surfaced in as yet a very small real world sample.

---

broken blades totally within the engine; and (2) all commercial jet aircraft are designed to fly with one engine inoperative. On the other hand, the FAA does consider as critical any cracks in the "fir tree" region of a turbine blade which is used to attach the blade to the hub of the turbine. (Should a turbine blade break in this region, it may be heavy enough to break through the engine shielding.) This is the region in which cracks are appearing in some Space Shuttle Main Engine turbine blades.

<sup>17</sup> Rogers Commission Report, Volume II, p. F-3.

<sup>18</sup> *Ibid.*

2. As a consequence, Orbiter landings appear high risk even under ideal conditions, which seldom occur. Exceptional procedural and skill demands are placed upon the pilots to nurse the brakes and tires through every landing. Landing rules have had increasing constraints imposed that hamper operational flexibility and usefulness of the Orbiter.

3. Brake and tire damage have been evident since early on in the program. The Rogers Commission seems very correct in finding the current landing gear system unacceptable. Resolution of landing gear system problems can no longer be put off.

### *Recommendations*

The Committee recommends that NASA:

1. Assemble all of the fragmented studies, analyses, and conclusions on landing gear problems and integrate them into one engineering description of the system as it is now intended to be used. This should include consideration of the basic strength of the struts themselves and their attachments.

2. Write a new *system* specification and match the proposed design improvements to an acceptable reliability and certification specification.

3. Design a test and certification program adequate to meet criteria to fly and to *continue* well into future operations until understanding and confidence in the landing gear system is attained.

4. In anticipation of requirements for a new brake specification, accelerate a program to provide:

Increased brake mass and/or heat sink;

Substantial increase in energy absorption;

Evaluation which weighs the experimental nature of the proposed 65 million foot pound carbon brake and its impact on the system against the penalty of weight of known materials (e.g. steel) for operational confidence.

5. Write updated subsystem specifications to upgrade the landing gear system to acceptable levels of performance to respond to the Rogers Commission's recommendations.

### *Discussion*

The sheer volume of testimony and documentation inevitably gives rise to apparent contradictions. None have surfaced that are assessed as consequential in evaluating the landing gear system problems (NASA's "anomalies") with a view to their solution.

The *main landing gear* (see Figure VI-1) consists of two heavily-loaded, two-wheel struts with two brakes on each and is designed for deceleration only. Roll-out and cross-wind steering correction was originally assigned to the nose wheel steering for the normal case. Each tire, wheel, and brake is supported by redundant fail operational anti-skid brake actuators, control valves, control boxes, and hydraulic power.

The *nose wheel* strut has two wheels on a common axle, no brakes, and is steerable. At the time of the accident nose wheel steering was not permitted except in an emergency because it did not have fail operational or fail safe redundancy. This places additional requirements on the main gear braking system that were a substantive source of main gear problems. Need for correction of

this oversight was most apparent and is the simplest of several difficult landing gear problem solutions. The lack of definitive action in five years of operations is not explained.

The *tires* apparently meet all of their design specifications but are critical for other reasons: (1) If a tire is soft or flat at the time of the nose down load spike (caused by negative lift on the wing, when the nose wheel makes contact) the other tire on that strut will take loads far in excess of its 130,000 pound limit and fail. (2) There is a body of opinion that at almost any time in the landing, one failed tire will assure the failure of its mate. (3) There is no assurance at launch that there is adequate pressure in any of the tires to assure spec performance. (3) Scuffing, cutting, abrading, and wear from spin up, asymmetrical braking (cross wind steering), surface roughness, and debris have been more than expected and disallow reuse of most tires (one landing per tire was spec). (4) Anti-skid becomes inactive at 20 knots and damaged brakes will lock up and blow both tires. It would appear that solving a host of other problems will resolve a number of the major tire problems.

The *brakes* by all standards are very large, very light, of conventional configuration, and very experimental because of extensive stretching of materials technology by using carbon-beryllium. Brake design is not rigorous, it is very empirical and results are often unpredictable in new designs. The Orbiter brakes incorporate beryllium stators and carbon lined beryllium rotors. Beryllium has low density, high strength, and high heat capacity. Beryllium is very tender and not well behaved at high temperatures. Beryllium has unreliable plastic characteristics at higher temperatures. Use of beryllium in lieu of steel saved perhaps 1000 pounds in the cumulative landing gear weight. The C-5A aircraft uses beryllium rotors and stators.

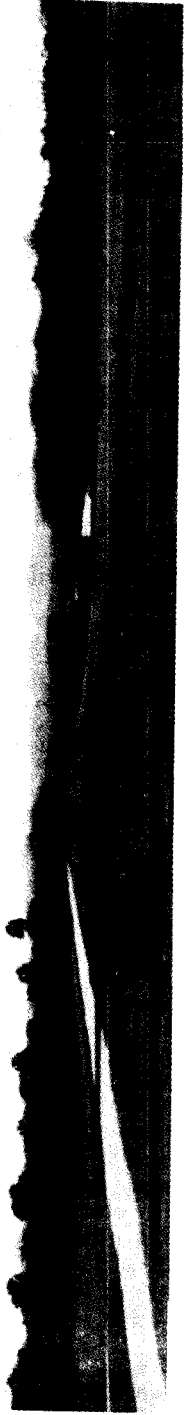
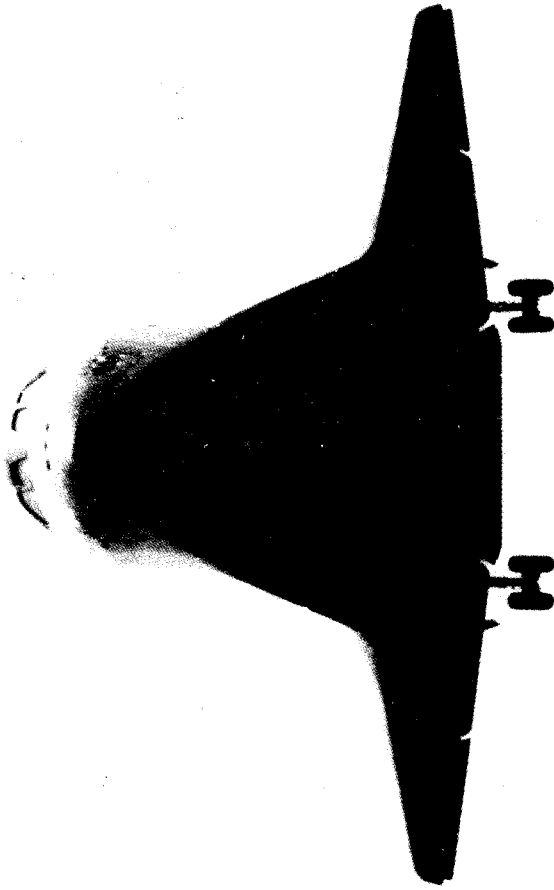

FIGURE VI-1

For the first 23 Orbiter flights, brake damage occurred to varying degrees on 15 flights for a sum of 32 damaged brakes. Failure seemed to favor the right hand gear. A great majority of these damages were not necessarily associated with heavy demands. A very few were caused by approaching the design energy absorption. A case cannot be made against the heavy footed pilot. Regression analysis indicates that there are no significant trends that show brake damage is a function of energy demands within limits, peak demands, or landing weight. It appears that the brakes, relieved of asymmetric steering loads, will approach design energy absorption specifications for one landing but those specs are inadequate to current requirements for repetitive operations.

The primary source of failure is cracking and fragmentation damage arising from hot spots and chatter or dynamic loads from vibrations. It was conjectured that these can be worse if the brake is lightly used ("not tightly clamped"). The pilots were given the astounding instructions to never release a brake once applied because if the brake is reapplied the loose fragments will destroy it and cause seizure.<sup>19</sup>

From the history unfolded to the Commission and Committee investigation, it is not difficult to understand why the landing gear system is marginal in today's operation. The original Orbiter design criteria were quite different and are in part:

System	Original Orbiter	Current Orbiter
Drogue chute.....	Primary deceleration.....	Deleted.
Nose wheel steering.....	Asymmetric loads.....	Delete-emergency only.
Tires.....	One landing per tire.....	Same.
Landing weight, abort (worst case).....	225,000 lb.....	240,000 lb.
Lightweight wheel brakes.....	Emergency, drogue back up and final deceleration.	Primary deceleration and stop.
Wheel brake life.....	5 landings dynamometer certified.....	Same.
	(Typical:	
	Bombers.....	40 landings.
	Airliners.....	100 landings
		5 max landings.
		1 emergency.
		(all without thrust reversal).

The whole operational load to decelerate, stop, and steer fell on what was originally the emergency backup brake system. The five landing design is impossible to fine tune to that degree and may yield only a design of imminent failure. It follows that every landing with the now increased normal and abort landing weights is an engineered emergency. How much the increased demands and weight have intruded into the landing gear strut design factor of safety and margin are unknown, but certainly a concern.

In summary, weight savings and inability to retrofit (i.e. larger tires and/or brakes) collided with the then state of the art resulting in the normal high risk of landing being compounded. It is a tribute to the pilots that they were able to carry such a tender system this far. Redundancy of tires and wheels has never been

<sup>19</sup> Rogers Commission, "Meeting of Challenger Commission; NASA, JSC", Halloway, T. et al., March 9, 1986, p. 313; and Bobko, K. et al., March 24, 1986, p. 152.



design practice. A successful landing could be made with both tires and brakes gone from one side with a steerable nose wheel and lateral stability from the opposite truck, if on a hard surface (concrete). The lake bed and stabilized overrun zones would probably be another matter.

Testimony implies that full-time nose wheel steering and higher capacity brakes are a top priority requirement for return to operations. Reference is made several times to a replacement 55 million foot pound all carbon brake in lieu of the 42 million foot pound carbon-beryllium brake. Rockwell International gave testimony that a 65 million foot lb. brake was in work.<sup>20</sup> To maintain the equivalent BTU's per pound, the carbon brakes must peak at much higher temperatures. This poses a new stress on the temperature environment of the tires and wheels. Carbon brakes used on the Concorde, B747, 757, 767 and C-5B are said to be experiencing dynamic failure modes. Carbon brake design has a better data base to work from than the beryllium but such a new brake will continue to be experimental and developmental in nature in the Orbiter application.

### *Issue 2*

What actions should be taken relative to other recurrent problems with flight hardware?

### *Finding*

There have been many instances of in-flight anomalies and failures of other elements of Space Shuttle hardware, some involving mission critical pieces of equipment. Some of these past problems have been corrected while others have not.

### *Recommendation*

NASA should ensure that before reinstating Space Shuttle flight operations, it fully understands and has corrected all instances of serious in-flight anomalous behavior or failures involving mission critical pieces of flight hardware.

### *Discussion*

Throughout the Space Shuttle program, there have existed a number of recurrent hardware problems in addition to those discussed elsewhere in this report. Some have already been solved. For others, new hardware has been ordered that hopefully will resolve the problem, while still other problems remain unsolved. Listed below are some examples of recurrent problems that have occurred with elements of Space Shuttle flight hardware:

Anomalous behavior of Space Shuttle Main Engine hydraulic actuators—on two occasions (STS-41D and STS-51F). This resulted in engine shutdown just prior to liftoff.

Numerous instances of failure of temperature and pressure sensors within Space Shuttle Main Engines—in one case (STS-51F) this resulted in the premature shutdown of a good engine

---

<sup>20</sup> Cmte Hgs, Transcript, July 15, 1986, p. 9.

during flight.<sup>21</sup> (During some periods of the launch phase, this could result in ditching of the Orbiter at sea, with probable catastrophic results.)

Frequent occurrence of cracks in turbine blades and sheet metal parts of Space Shuttle Main Engines, requiring that engine components be replaced often.

Nonconsistent erosion performance of Solid Rocket booster nozzles—with one instance (STS-8) nearly resulting in a potentially disastrous “burn through”.

Evidence of damage to Solid Rocket Booster nozzle O-rings in 13 of the 23 missions for which the booster sets were recovered.<sup>22</sup>

Malfunctions in the Solid Rocket Booster recovery system (e.g., parachutes)—with one occurrence (STS-4) resulting in the loss of a flight set of Solid Rocket Boosters.

At least 48 instances of anomalous inflight behavior of the Auxiliary Power Units that drive the Orbiter's flight controls during launch and landing.<sup>23</sup> In one case (STS-9), two auxiliary power units failed during landing, shutdown, and then exploded several minutes after the Orbiter had come to a stop on the runway.

Anomalous behavior or total failure of the General Purpose Computers on the Orbiter.

Ejection of thermal insulation from the “intertank” region of the External Tank (i.e., the region between the liquid oxygen and liquid hydrogen tanks), causing tile damage on the Orbiter.

Failures in the Orbiter's Thermal Protection System, including the loss of tiles, the disconnection of thermal blankets, and chemical decomposition of the “screed” layer beneath many tiles on the Orbiter Challenger.

At least 63 instances of anomalous inflight behavior of the Reaction Control System that controls the flight orientation of the Shuttle while in orbit and during the initial stages of re-entry.<sup>24</sup>

At least 78 cases of anomalous inflight behavior of the communications and tracking equipment on board the Orbiter.<sup>25</sup>

Clearly, some of these problems are more serious than others, and as noted earlier, some have been solved. However, the Committee is mindful of the conclusion of the Rogers Commission regarding the existence of similar situations for the Solid Rocket Motor prior to STS 51-L: “a careful analysis of the flight history of O-ring performance would have revealed the correlation of O-ring damage and low temperature.”<sup>26</sup> Also referring to Criticality I flight hard-

<sup>21</sup> The two events mentioned in this and the preceding paragraph involving Main Engines on STS-51F were separated by 17 days, with the pad abort due to an actuator failure occurring on July 12, 1985, and the inflight abort due to a double thermocouple failure occurring on July 29, 1985.

<sup>22</sup> Rogers Commission Report, Volume I, pp. 129-31.

<sup>23</sup> NASA, “Shuttle Flight Data and Inflight Anomaly List, Revision H,” Johnson Space Center, Houston, Texas, January, 1986, pp. 2-8 and 2-9.

<sup>24</sup> *Ibid.*, pp. 2-6 and 2-7.

<sup>25</sup> *Ibid.*, pp. 2-16 and 2-17.

<sup>26</sup> Rogers Commission Report, Volume I, p. 148.

ware elements, the Commission recommended that, "NASA should establish a system of analyzing and reporting performance trends for such items."<sup>27</sup>

In a similar vein, Dr. Feynman observed:

The argument that the same risk was flown before without failure is often accepted as an argument for the safety of accepting it again. Because of this, obvious weaknesses are accepted again and again, sometimes without a serious attempt to remedy them, or to delay a flight because of their continued presence.

And,

The acceptance and success of these (previous) flights is taken as evidence of safety. But erosion and blow-by are not what the design expected. They are warnings that something is wrong. The equipment is not operating as expected, and therefore there is a danger that it can operate with even wider deviations in this unexpected and not thoroughly understood way.<sup>28</sup>

In the spirit of these observations, it would seem clear that NASA should make sure that it fully understands all past instances of inflight anomalies and failures involving critical elements of hardware. Then, when appropriate, NASA should correct the underlying causes of these anomalies and failures.

### *c. Other Engineering Concerns*

#### *Issue*

What action should be taken relative to other engineering concerns regarding critical elements of Space Shuttle flight hardware?

#### *Finding*

In recent years, serious engineering concerns have been raised regarding the safety of some elements of Space Shuttle flight hardware, such as the 17 inch flapper valve and the heat exchanger feeding the liquid oxygen tank.

#### *Recommendation*

1. NASA should ensure that, as a part of its current review of Space Shuttle safety, it identifies, thoroughly evaluates, and then takes appropriate action on all serious engineering concerns raised regarding mission critical elements of Space Shuttle flight hardware.

2. NASA should give special attention to both the cost and risks of using Filament Wound Case Solid Rocket Boosters for very heavy Space Shuttle payloads versus the cost and programmatic impacts of simply transferring those payloads to expendable launch vehicles.

<sup>27</sup> Ibid., p. 201.

<sup>28</sup> Ibid., Volume II, p. F-1.

### *Discussion*

In the months since the Challenger accident, there has been renewed interest in scrutinizing engineering concerns that have been raised in recent years regarding the safety of some elements of Space Shuttle flight hardware. Typical examples of some of these concerns involve the following pieces of equipment:

The 17 inch "flapper valves" on the fuel lines between the External Tank and the Orbiter. The inadvertent closing of one of these valves before Main Engine shutdown could be catastrophic, causing a rupture of a fuel line and/or the External Tank. Failure to close after engine shutdown, on the other hand, could cause the External Tank to crash into the Orbiter after being jettisoned.

The heat exchanger used to produce gaseous oxygen to pressurize the liquid oxygen tank in the External Tank. This heat exchanger is located inside one of the turbopump preburners of the Space Shuttle Main Engine. Should a rupture occur in the wall of the heat exchanger, high temperature hydrogen gas could be driven into the liquid oxygen tank or additional oxygen could be driven into the preburner—either situation could be catastrophic. A solution to this problem could be to move the heat exchanger outside of the Main Engine, possibly using the engine's hydrogen cooling jacket as a source of heat to produce the required gaseous oxygen.

The Filament Wound Case version of the Solid Rocket Booster now under development for use in launches involving very heavy Space Shuttle payloads. The Aerospace Safety Advisory Panel argues that this system may have questionable structural strength safety margins in the transition areas between individual case segments.<sup>29</sup> Safety concerns such as these have been raised regarding the Filament Wound Case Solid Rocket Boosters by the Aerospace Safety Advisory Panel for several years. In testimony before the Committee on May 15, 1986, Mr. John Brizendine, Chairman of the panel, repeated a conclusion from the panel's most recent report: "Until the issue can be resolved with a high level of confidence, . . . the Filament Wound Case Solid Rocket Boosters should not be used for STS launch. . . ."<sup>30</sup>

Regarding the last concern in the above listing, the Committee notes that the recent decisions to substantially delay the availability of the Space Shuttle launch facilities at Vandenberg Air Force Base and to increase the availability of expendable launch vehicles could potentially eliminate the need for Filament Wound Case Solid Rocket Boosters. Specifically, the Filament Wound Case Solid Rocket Boosters were originally intended only for use at Vandenberg; and the increased availability of large expendable launch vehicles may provide a viable option to heavy-lift launches using the Space Shuttle.

<sup>29</sup> Hearings before the Space Science and Applications Subcommittee of the House Science and Technology Committee, "Strategy for Safely Returning Space Shuttle to Flight Status," 99th Cong., 2nd Sess., Transcript, May 15, 1986, p. 102.

<sup>30</sup> *Ibid.*

The current requirement for preeminent emphasis on Space Shuttle flight safety obviously necessitates that all major engineering concerns such as those listed above should be identified, thoroughly scrutinized, and appropriately acted upon.

d. Desirable Tests Not Yet Approved

*Issue 1*

Is the current ground test program for the SSME adequate to provide a complete understanding of the engine's operating characteristics and safety margins?

*Findings*

1. The Committee supports the Findings and Conclusions of the Development and Production Team concerning the SSME, particularly the concern that "Hardware availability and the potential of damage to hardware and facilities resulting from tests malfunctions have constrained . . . [full margin] . . . testing during the ground test program."<sup>31</sup>

2. The Committee shares Dr. Feynman's concern that there has been a slow shift toward decreasing safety in the SSME program.

3. There is not a sufficient understanding of SSME blade cracks and fractures.

*Recommendations*

1. The Committee concurs with the Development and Production Team conclusion that over testing, limits testing, and malfunction testing in the SSME program should be re-emphasized to demonstrate full engine capability.<sup>32</sup>

2. NASA should prepare and submit to the Committee a cost-benefit analysis of testing a SSME to destruction including: (a) utilizing additional SSME test stands; (b) utilizing additional hardware for the ground test program; and (c) the value of such a test.

3. A vigorous study of fracture behavior should be conducted to minimize the hazard of cracked SSME blades and to increase the reliability and safety margin of blades. New blades and/or new policies for duration of blade use should be incorporated prior to the next Shuttle flight.

*Discussion*

The development and operation of the SSME is a remarkable achievement and represents the leading edge of technology in large liquid hydrogen/liquid oxygen rocket engines. Great attention to detail was emphasized by engineers at both Rocketdyne and Marshall as well as timely recognition and resolution of technical problems.<sup>33</sup> Despite intense oversight, individuals privately speculated, prior to the 51-L accident, that if an accident were to occur it would probably be the result of an SSME failure simply because of the uncertainties innate to a technology pushing the "edge." This awareness of the uncertainties promoted high quality engineering and contributed to the success of the SSME program unlike the ap-

<sup>31</sup> Rogers Commission Report, Volume II, p. K-32.

<sup>32</sup> Ibid.

<sup>33</sup> Ibid.

parent complacent attitude toward the mature solid rocket technology.

Volume II of the Rogers Commission Report analyzes in great detail the development, production and operation of the SSME.<sup>34</sup> The Commission's Findings and Conclusions regarding the SSME are appropriate. However, the Committee feels that even more rigorous testing of the main engine is necessary to ensure that safety margins and hardware reliability are not compromised.

For example, Commission member Dr. Feynman notes that the "top-down"<sup>35</sup> approach used to design the SSME has made it difficult and expensive to discover the causes of component and subsystem problems.<sup>36</sup> Specifically, Dr. Feynman writes that NASA and Rocketdyne (the SSME prime contractor and a division of Rockwell International), do not have a relatively precise knowledge of when a turbine blade is likely to crack, how quickly a crack will grow to fracture, and under what various rated power levels these phenomena will occur.<sup>37</sup>

Mr. Jeffs, President, North American Space Operations, Rockwell International, described the blade problem and explained Rocketdyne's testing efforts to improve blade life and minimize blade cracks and fractures.

. . . we are working the blades and bearing problems and have been for some time.

We have given ourselves confidence in flying the engine with those kinds of blades through off-limit testing. We've taken the worst cracked blades we could possibly find and run them in engines to see if we could make those cracks grow. We have not been able to do so. At the same time, it's not satisfactory for us to continue in the long-term flying cracked blades, and that's why we're putting so much effort on fixing those blades. I believe that we should have fixes for those blades before the next flight.

. . . the blades on the engines . . . I hedge a little bit on exactly when we can incorporate those into the vehicle. I believe we can do it by the 1988 period, but it's going to take a lot of certification testing . . .<sup>38</sup>

During staff discussions with NASA personnel, the issue of SSME destruction testing arose. Some NASA personnel expressed the desire to test an SSME to destruction, but noted the lack of test stands and hardware.<sup>39</sup> Currently, NASA and Rocketdyne have three test stands. Some individuals privately noted that the SSME program should have four or five test stands to run and engine to destruction, to test product improvements, for flight support and anomaly resolution, and for acceptance tests of hardware. Others have explained that it is not necessarily the number of test stands that is the key to a successful SSME program, but rather the

<sup>34</sup> Ibid., pp. K-23 through K-27; K-31.

<sup>35</sup> Most military and civilian aircraft engines are designed from the bottom-up approach, in which each component, starting with the material used all the way through engineering testing of subsystems and subcomponents, is evaluated prior to the final design of the entire engine.

<sup>36</sup> Rogers Commission Report, Volume II, p. F-2.

<sup>37</sup> Ibid.

<sup>38</sup> Cmte Hgs, Transcript, July 15, 1986, pp. 10-12, 61.

<sup>39</sup> Discussion with NASA personnel, Washington, D.C., May 30, 1986.

amount of hardware available to feed the test stands. The Rogers Commission found that:

The number of engine test firings per month had decreased over the past two years. Yet this test program has not yet demonstrated the limits of engine operation parameters or included tests over the full operating envelope to show full engine capability. In addition, tests have not yet been deliberately conducted to the point of failure to determine actual engine operating margins.<sup>40</sup>

In addition, Dr. Feynman said:

Using the completed engine as a test bed to resolve such questions is extremely expensive. One does not wish to lose entire engines in order to find out where and how failure occurs. Yet, and accurate knowledge of this information is essential to acquire a confidence in the engine reliability in use. Without detailed understanding, confidence can not be attained.<sup>41</sup>

There has been some concern raised about the value of testing an SSME to destruction. It is important that engine testing simulate flight as closely as possible so that information learned in testing can readily be applied to actual flight engines. For example, running an engine longer than an actual flight may not be useful in understanding what effects starting and stopping have on lifetimes of engine components, such as turbine blades. However, damaging or destroying an engine while testing components under flight conditions will yield valuable information. Consequently, it is important for NASA and Rocketdyne to aggressively test components to their design life even at the expense of a ground failure. It is understandable that the 51-L accident may have resulted in a more conservative SSME ground test program in terms of a fear of failure. However, if safety is to be the prime consideration in the STS program, then there has to be the freedom to fail in order to learn. It is far better to lose an engine on the ground than in flight.

### *Issue 2*

Is the leak/combustion threat of the External Tank's hydrogen pressure valve a hazard warranting testing?

### *Findings*

1. The Committee supports the Rogers Commission concern regarding the hazard posed by the liquid hydrogen vent and relief valve.<sup>42</sup>
2. The Committee supports the intent of the ET prime contractor, Martin Marietta, to pursue outdoor wind tunnel testing to eliminate the liquid hydrogen vent/relief valve hazard.<sup>43</sup>

<sup>40</sup> Rogers Commission Report, Volume I, p. 192.

<sup>41</sup> *Ibid.*, Volume II, p. F-2.

<sup>42</sup> *Ibid.*, Volume I, pp. 192-93.

<sup>43</sup> *Ibid.*, Volume II, p. K-23.

### *Recommendation*

NASA, in conjunction with the appropriate contractor, should consider designing and conducting an ET liquid hydrogen leak/burn test to determine if corrective actions should be taken prior to the next Shuttle flight.

### *Discussion*

The Rogers Commission identified the hazard posed by the partially open vent/relief valve on the ET's liquid hydrogen tank. This valve can indicate it is closed when, in fact, it might be partially open. A liquid hydrogen leak and subsequent combustion could result in the loss of vehicle and crew.<sup>44</sup> There are two ways of determining if the valve is closed. While both are highly accurate, neither can adequately assure closure. To date,

. . . no test has been permitted to leak and burn hydrogen in a wind tunnel and analytical methods of determining the heating rates associated with leaking hydrogen gas into the 1.5-foot thick boundary layer of External Tank are recognized by the analyst to be inadequate and inconclusive.<sup>45</sup>

During the Commission investigation representatives of Martin Marietta stated a concern for the vent/relief valve leak hazard and indicated an intent to pursue outdoor wind tunnel testing.<sup>46</sup>

### *Issue 3*

Does the present Range Safety System (RSS) on the External Tank present an unreasonable risk?

### *Finding*

There is substantial controversy over the relative benefits and risks of the present RSS on the External Tank.

### *Recommendation*

The Committee believes the Administrator should prepare and submit to the Committee a comprehensive review of RSS requirements.

### *Discussion*

There has been considerable discussion through the years about the advantages and disadvantages of having a Range Safety System (RSS) radio controlled destruction device on the External Tank.

There have been recorded instances of spacecraft being struck by lightning during the launch.<sup>47</sup> At least some of the astronaut corps feel strongly that the ET RSS creates an unnecessary risk to the crew.

The Committee has been informed that the ET RSS was included during the design phase because of a range safety requirement.

<sup>44</sup> *Ibid.*, Volume I, pp. 192-93.

<sup>45</sup> *Ibid.*, Volume II, p. K-23.

<sup>46</sup> *Ibid.*

<sup>47</sup> NASA, *The Apollo Spacecraft, A Chronology*, 1978, Volume IV, p. 319, Appollo 12.



The question that should be asked is: "Do the relative risks and advantages of an ET RSS justify its inclusion as a part of the STS?"

Therefore, the Committee believes that as part of an overall review of safety requirements, the Administrator should ensure that NASA and the appropriate Air Force officials responsible for range safety requirements review RSS requirements as they apply to the ET.

#### e. Production/Refurbishment Issues

##### *Issue 1*

Should 100 percent X-ray inspection of the propellant and insulation for the Solid Rocket Motors (SRM) be resumed?

##### *Findings*

1. Previous X-ray inspections led to only one SRM being rejected for Shuttle use.

2. There is no non-destructive inspection method which can guarantee a defect-free SRM. X-ray inspection cannot detect "kissing" voids in which the SRM insulation is touching the SRM steel casing but is not bonded to it. Debonded insulation at the end of an SRM segment could provide burning propellant gases with a path to the SRM steel casing and could result in loss of vehicle and crew. X-ray inspection can detect propellant cracks and large voids which if undetected could also result in a catastrophic situation.

3. Although there is no guarantee that X-ray inspection has been a particularly effective method of detecting propellant and insulation SRM flaws, it remains one of the best available methods to monitor the SRM manufacturing process.

##### *Recommendations*

1. NASA should consider reinstating full X-ray inspection of the propellant and insulation for all motors used on succeeding flights until new, more accurate inspection methods can be developed and implemented and there is unquestionable confidence in the SRM production process.

2. NASA, in conjunction with the appropriate contractors, should investigate the development of new, more accurate inspection techniques which can detect "kissing" voids and other potential defects that cannot be detected by X-ray inspection.

##### *Discussion*

While the 51-L accident has focused attention on the design of the SRM joint, the explosion of a Titan 34D rocket on April 18, 1986, has focused attention on the production and inspection processes of the SRM. Evidence has shown the Titan failure was caused by a "thermal insulation coating that pulled away from inside one of the two Solid Rocket Booster motors, allowing hot propellants to burn through the rocket's outer casing" nine seconds after being fired from Vandenberg Air Force Base.<sup>48</sup>

<sup>48</sup> Michael Isikoff, "Major Flaws Ruled Out in Two Rockets," *Washington Post*, July 3, 1986, p. A-1.

The Titan Solid Rocket Motors receive only visual inspection of bond lines and local ultrasonic inspection as required.

While there are some significant differences between the Shuttle SRB and the Titan motor, the design of the Shuttle SRB was primarily based on the Air Force's Titan III solid rocket.<sup>49</sup> Also, the design of the insulation on the Shuttle booster is virtually identical with the Titan design.<sup>50</sup> Brig. Gen. Nathan Lindsay, Chairman of the Air Force board investigating the accident said, "This was a failure we would have assigned a very low probability to. We've flown 70 flights with the [Titan] Solid Rocket Motor and this was the first failure."<sup>51</sup>

The Shuttle SRB has flown 25 flights with one unrelated failure. In testimony before the Rogers Commission, NASA officials "made it clear that the kind of separation of insulation that apparently led to the destruction of the Air Force Titan 34D was commonplace on the Shuttle."<sup>52</sup> According to NASA officials, it was also common practice to visually inspect and repair unbonded insulation of the SRM end segments.<sup>53</sup>

Full X-ray inspection was conducted on all SRM segments used in the demonstration and qualification programs and the first five Shuttle flights. Full X-ray inspection of these early motors was required as part of the development and verification plan, and was scheduled for reassessment after the flight of STS-5. During this period 24 motors were fully X-rayed. Three demonstration center motor segments exhibited excessive voids in their propellant, but only one segment was rejected. Studies established the voids were due to low casting rate and the method of dispersing propellant into the segments. As a result controls were implemented and verified by X-ray inspection. It was also discovered during this time that an SRM segment of the size required for the Shuttle could contain 12,000 voids and be fired successfully without threat to the mission, vehicle or crew.

After evaluation of data from the SRM segments used up through STS-5 and data from military Solid Rocket Motors, NASA's confidence in the SRM production process was such that the SRM X-ray policy was changed. A cost-benefit analysis also contributed to this decision. Beginning with STS-6, X-ray inspection was only conducted on all aft segments in the propellant hand-trimmed area and the segment produced following the identification of a process anomaly, process change, or design change. X-ray inspection of the aft segments in the propellant hand-trimmed area was continued because data indicated that only 3 percent of a segment's insulation had to be bonded, particularly the ends, in order of the segment to burn properly and safely. In October of 1985 NASA implemented a recommendation from the Aerospace Advisory Panel to change its X-ray policy to include random inspection of one SRM segment per month. Because of a SRM production lead

<sup>49</sup> Rogers Commission Report, Volume I, p. 121.

<sup>50</sup> David E. Sanger, "Flaw in Titan's Boosters is Identified," the *New York Times*, June 4, 1986, p. A-23.

<sup>51</sup> Isikoff, pp. A-1, A-20.

<sup>52</sup> Sanger, p. A-23.

<sup>53</sup> *Ibid.*

time of approximately eight months, no SRM segment inspected under this new policy was flown before the 51-L accident.<sup>54</sup>

X-ray inspection, while the best available method to detect propellant voids and cracks, cannot detect so-called "kissing voids" in which the insulation is touching but not bonded to the SRM steel casing. Staff discussions with NASA personnel revealed that other inspection methods are being analyzed. Thermography and acousticolography techniques could both be used to detect voids and unbonded insulation. These techniques may not be refined enough to use on the boosters flown on the next Shuttle flight. However, a mechanical pull test should be available to test the new motors to ensure that insulation is bonded to the SRM steel casings prior to pouring the propellant. In addition, NASA will reinstate its initial 100 percent full X-ray policy which applied to the earlier demonstration motors and first five flights. According to NASA officials the continued use of X-ray inspection once Shuttle flights have resumed will depend upon success of the new SRM design and development of new inspection techniques.

### *Issue 2*

Are all production and other activities involving Criticality 1 and 1R hardware at prime and secondary contractor facilities labeled as "critical" processes?

### *Findings*

1. Critical processes are formally identified and controlled by NASA. All processes are classified and controlled by the contractor's Process Change Control Board.<sup>55</sup>

2. The O-ring used in the case joint is critical to the sealing integrity of the joint, yet it is not designated as a "critical process by either the Parker Seal Co. or Hydrapak, the manufacturer and supplier respectively.<sup>56</sup> This raises the possibility that other Criticality 1 and 1R hardware components are also not appropriately designated by their manufacturer as "critical" processes.

### *Recommendations*

1. NASA should require the manufacture of critical items, such as the O-rings, to be designated "critical" processes. Contractors should formally notify their employees involved in critical manufacturing processes of the serious nature of particular production processes.

2. NASA should conduct a thorough review to ensure that all manufacturing processes involving Criticality 1 and 1R hardware components of prime and secondary contractors are appropriately designated "critical" processes.

### *Discussion*

"Critical processes are formally identified and controlled by NASA. All processes are classified and controlled by the contractor's Process Change Control Board."<sup>57</sup> Failure of Criticality 1 and

<sup>54</sup> Discussion with NASA personnel, Washington, D.C., Sept. 12, 1986.

<sup>55</sup> Rogers Commission Report, Volume II, p. K-14.

<sup>56</sup> *Ibid.*, p. K-31.

<sup>57</sup> *Ibid.*, p. K-14.

1R components or systems will result in loss of vehicle and/or crew. The Commission's investigation revealed that the O-ring used in the case joint, whose failure led to the destruction of 51-L, was not designated a critical process.<sup>58</sup> NASA personnel explained that O-ring production was not so classified because final O-ring inspection occurred at KSC.<sup>59</sup>

NASA's safety, reliability and quality assurance (SR&QA) philosophy is that you cannot inspect quality into products, rather you must build it in. It is questionable, then, why NASA would choose to rely solely upon O-ring inspection for quality control and not emphasize the criticality of the O-ring production process to the O-ring manufacturers and their employees.

While the O-ring manufacturing process did not contribute to the 51-L accident, the fact that such a critical item was not designated a critical process raises the possibility that other critical items may not be so designated. Identifying critical processes and educating contractors and subcontractors about critical items and manufacturing processes would be in line with NASA's policy of building in quality and safety.

### *Issue 3*

Do O-ring repairs compromise safety?

#### *Finding*

The Committee supports the Development and Production Team Finding and conclusion that the "limit of five repair joints per O-ring is an arbitrary number" and that "repair of inclusions and voids in the rubber . . . appears to be an area of potential problem."<sup>60</sup>

#### *Recommendation*

NASA should review its O-ring repair policy and contractor repair practices in terms of their effects on O-ring performance and safety. Such review should be completed prior to the resumption of Shuttle flights if, as anticipated, the new SRB joint design uses O-rings.

#### *Discussion*

The NASA/Commission Development and Production Team questioned the adequacy of the SRM joint O-ring process and quality control. According to the D&P Team, "the O-ring is allowed to include five scarf joints, a quantity which is arbitrarily established, and repairs of inclusions and voids are routinely made by the vendor after receipt of the material supplies".<sup>61</sup>

### *Issue 4*

What impact does growth of SRM case size have upon booster and Shuttle performance and safety?

<sup>58</sup> *Ibid.*, p. K-31.

<sup>59</sup> Staff meeting with NASA personnel, Headquarters, Washington, D.C., May 13, 1986.

<sup>60</sup> Rogers Commission Report, Volume II, p. K-31.

<sup>61</sup> *Ibid.*, p. K-3.

### *Finding*

The Committee concurs with the Development and Production Team Finding that "Remeasurement of two used SRM case segments indicated both tang and clevis sealing surfaces have increased in diameter beyond the anticipated design limits." <sup>62</sup>

### *Recommendation*

NASA and the appropriate contractor should resolve through analysis and testing prior to the next Shuttle flight the cause of SRM case size growth and its impact upon booster and Shuttle performance, reliability of refurbished SRM case segments, and safety.

### *Discussion*

During the investigation of the 51-L accident, the NASA/Commission D&P Team "determined by measurement of two flown case segments that both the SRM tang and clevis sealing surfaces have increased in diameter beyond the anticipated design limits. The growth is believed to be material related and related to the hydrostatic proof test pressure level." <sup>63</sup>

#### f. Review of NASA's Redesign/Recertification Plan

### *Issue*

Is NASA's SRM redesign and hardware recertification plan a viable and realistic one which will result in a safer, more reliable Space Transportation System?

### *Findings*

1. NASA's SRM redesign plan is a step in the right direction. Moving the proposed launch date beyond June 1987 is a responsible and realistic decision. The membership of the SRM Redesign Team is representative of qualified individuals in and outside of NASA. With the expert assistance of the specially appointed National Research Council (NRC) Independent Oversight Group, the new SRM design should be a significantly safer and more reliable Shuttle element.

2. NASA's current hardware recertification plan is also a step in the right direction. The use of independent review contractors distinguishes this recertification plan from earlier reviews. However, given the failure of previous reviews to discover the deficient SRB joint certification, the Committee is concerned there is still the possibility that the recertification effort may not reveal other certification deficiencies, if indeed they exist. The plan also raises concern about the qualifications of independent reviewers to evaluate certain elements given the uniqueness of particular Shuttle components.

3. The joint was never fully tested as a separate element of the SRM. The various forces that act on the joint during stacking, launch, and flight are difficult, if not impossible, to duplicate in a test of the joint under all conditions that could be experienced during launch and flight.

<sup>62</sup> Ibid., p. K-31.

<sup>63</sup> Ibid., p. K-3.

4. It is unclear what function the new Safety Office will perform in the redesign of the SRB field joint and other critical elements of the Shuttle, as well as NASA's recertification plan.

#### *Recommendations*

1. The Committee recognizes the national need to return the Shuttle to flight status as soon as reasonably possible. As noted in NASA's July 14, 1986, report to the President, safety will determine the launch schedule. However, NASA should consider the proposed launch date of early 1988 as a flexible one which should be slipped further if necessary. The Shuttle should not be launched again until NASA can assure that safety criteria have been met.

2. In establishing a test program to certify the new Solid Rocket Motor design, NASA should consider the feasibility of including in combination and in the proper sequence all of the thermal and structural loads expected to be experienced by the Solid Rocket Motor during ignition, lift-off, and flight.

3. The independent review contractors participating in the hardware recertification plan should utilize sufficient specific technical expertise to insure adequate recertification of all elements of the STS.

4. The Committee requests that the new Office of Safety, Reliability and Quality Assurance conduct an independent assessment of the SRB field joint redesign efforts. In addition, the new office should also be integrally involved in reviewing all other critical component redesign efforts and NASA's recertification plan.

#### *Discussion*

The "Strategy for Safely Returning the Space Shuttle to Flight Status" includes the plans to redesign the SRM joint, reverify hardware design requirements, and to completely review all "critical" items. This strategy was proposed March 24, 1986, by Admiral Truly, the Associate Administrator for Space Flight and supplements the Rogers Commission's recommendations.<sup>64</sup>

The redesign of the SRM joint is being conducted and supervised by a cross section of competent and qualified individuals from NASA centers, including Marshall Space Flight Center, the Astronaut Office, and individuals from outside NASA. An expert advisory panel of 12 people, six from outside NASA, has also been appointed. Further, at the request of the NASA Administrator, the National Research Council has established an Independent Oversight Group which reports directly to the Administrator. (See Appendix VI-B.)

To date, "many design alternatives have been evaluated, analyses and tests have been conducted, initial verification plans have been established, and overall schedules have been developed."<sup>65</sup> In addition to designing a new joint that will use existing hardware, an alternate design that does not use current hardware is also underway. Study contracts have been let to five companies to independently develop new designs and review current baseline ideas and tests already conducted by NASA.

<sup>64</sup> NASA Response to Rogers Commission, July 14, 1986, pp. 37-40.

<sup>65</sup> *Ibid.*, p. 12.

In 1985, as joint problems continued with the Solid Rocket Motors, NASA recognized the need for a design that would limit the rotational movement between the joint tang and clevis that occurs at motor ignition. NASA was embarking on the design of a Filament Wound Casing which would have the advantage of allowing for an increase in payload. Since a new design was called for, it was to NASA's advantage to correct some of the joint problems at this time. In the new design, to reduce the rotational movement in the joint, a hook was added to the inner leg of the clevis. This would significantly limit any change in the spacing gap between the tang and the clevis in the area where the O-rings are installed. Shortly thereafter, Thiokol, on its own initiative, ordered new forgings which were thicker in the tang area so that the capture feature could be machined into the casing. The hook has become known as the "capture feature". In August of 1985, however, the capture feature then under consideration was significantly different than current joint designs with the capture feature. Some of these differences include the presence of a third O-ring, the addition of a second pressure test port, the adoption of an interlocking design for the case insulation in the vicinity of the joint, and the removal of all putty from the joint.

The new design, however, with the capture feature, appears to complicate the stacking operations and could increase the potential for damage, particularly leading to the creating of metal shivers during mating operations.

The hardware recertification plan appears to be a thorough approach to verifying that components meet design requirements. The recertification plan involves three levels of review to be conducted by: (1) NASA personnel; (2) current Shuttle contractors; and (3) independent contractors.

A major concern about the thoroughness of the hardware recertification plan was expressed by Mr. Nelson:

. . . looking back on how the whole system functioned we found out that there were a whole bunch of people involved in the SRB design and the certification process. There were the internal groups at Thiokol; there was the oversight by Marshall; there was a through review by an outside group, headed by Dr. Williams; there was the Aerospace Safety Advisory Panel; there was the certification process and signing off, [not only for the test flights] but for the first Shuttle flight, STS-1; and then there was that same certification process and signing off again that occurred before STS-5.

Now, still all of those problems went undetected by so many groups.<sup>66</sup>

A more detailed discussion of previous hardware certification is in Section VI-A.1.a. of this report.

Mr. Nelson further asked how this plan could provide confidence that it is relatively safe to fly again.

---

<sup>66</sup> Cmte Hgs, Transcript, July 15, 1986, p. 95.

The use of independent contractors distinguishes this recertification plan from previous ones. Mr. Davis, President, Martin Marietta Michoud Aerospace, said:

. . . some of the things that are being done differently . . . I think will help . . . Marshall Space Flight Center has contracted with other companies for independent FMEA/CIL assessments of their hardware. In particular, Rockwell is doing a total independent assessment of my External Tank hardware, and I think that's well looked-to. I look to their expertise to question everything we did and maybe give us some advice on how to make it better.<sup>67</sup>

Mr. Murphy, Executive Vice President and General Manager, United Technology Booster Production Company, commented:

I think one of the things that is going to prevent a recurrence of what happened in the past, as far as oversight committees are concerned, is that we have come a long ways since the initial certification of the program. We now have advanced analytical tools which were not available before. We also have the flight environments for the 24 successful flights; it gives us a true indication of what the environment is that we're going to be facing. Plus, again, the environment of the whole aerospace industry has changed dramatically since 51-L. And all of these, I think, will be taken into consideration and will provide the oversight and the proper review of items that never occurred before.<sup>68</sup>

Mr. Murphy explained how his company will recertify the new SRB design:

The recertification has three primary elements which follow a logical progression of evaluation. First, we will reestablish the basic design requirements from Level II and Level III. Second, we will establish a verification program based upon those requirements. And third, we will reestablish that the design and the hardware are in compliance with the first two elements.

Key activities to be performed as we recertify the SRB will include the traceability of all the requirements into all levels of SRB design and system environments, verification of the SRB design data base and analyses, establishment of tools such as the failure modes and effects analysis, and validation that our paper systems have properly incorporated requirements, constraints, and criteria.<sup>69</sup>

Another distinction of this plan is that hardware will be completely recertified through actual testing and analysis as if it were being done for the first time. Some earlier certification reviews were abbreviated paper checks many of which focused on only certain components.

---

<sup>67</sup> Ibid., p. 96.

<sup>68</sup> Ibid., p. 98.

<sup>69</sup> Ibid., p. 50.



Mr. ROE. . . . we're talking, where at all possible, actual field testing. Do you concur with that approach? . . .

Mr. DAVIS. Yes, I'd say I agree with that. As a matter of fact, I believe that's what all the program contractors, are out doing at this point.<sup>70</sup>

The use of independent review contractors is a necessary and critical component of the recertification plan. However, a legitimate concern has been raised by the current contractors and Committee staff regarding the ability of independent contractors to review technologies and components for which they may have limited expertise. For example, solid and liquid rocket propulsion has often been referred to as a "black art" for which there are few experts. NASA has contracted with Martin Marietta to independently review the SRB and SRM certification. Understanding the uniqueness of rocket propulsion, Martin Marietta has supplemented their in-house talent with outside experts to assist in the certification review.

The complete review of the Critical Items List (CIL), Hazard Analyses (HA), and Failure Modes and Effects Analyses (FMEA) is in response to the Rogers Commission's third recommendation and is intended to identify those items that must be improved prior to flight, and to affirm the completeness and accuracy of each FMEA/CIL for the current NSTS design. This is the first such review since the system was originally instituted at the beginning of the NSTS program and involves, according to NASA, many man-hours of effort and a very large staff. Supporting this effort are independent contractor reviews of the various FMEA/CIL activities associated with each major component and system of the National Space Transportation System. There are six such activities. These include, in addition to the four major subsystems that comprise the Shuttle (Orbiter, Solid Rocket Booster, Space Shuttle Main Engine, and the External Tank), the Vandenberg Launch Site and the Kennedy Space Center operations. The re-evaluation is scheduled to be completed by March 1987. It will involve all levels of NASA management, with auditing and oversight functions to be provided by outside personnel from the Aerospace Safety Advisory Panel and the National Research Council in accordance with the recommendations of the Rogers Commission.

A reconsideration of the level of design center involvement (i.e., the field centers that are responsible for designing various components of the Shuttle) in equipment processing or systems processing is required. The establishment of an Office of Safety, Reliability and Quality Assurance under a separate Associate Administrator should lead to improvements or an increase in the audit activities associated with the overall development and production process activities within the program. A systems design review that is presently underway within NASA has led to some 70 or 80 items over and above the CIL review that have been brought to the attention of Level II as potential problem areas.<sup>71</sup>

---

<sup>70</sup> Ibid., pp. 59-60.

<sup>71</sup> Discussion with NASA officials, Washington, D.C., July 10, 1986.

Program management at Level II has requested a complete audit of the problem reporting system in order to assure that only priority issues are elevated to the Level II status for review. NASA suggests the problem has been that too many items of lower categorization than Criticality 1 or 1R have been brought up to Level II and have swamped the ability of this management level to adequately analyze Criticality 1 items.

The new office of Safety Reliability and Quality Assurance is now operational. It is the view of the new Associate Administrator that the role of the SR&QA office will be to assure that modifications to the SRB field joint design, are extensively reviewed during the processes of development, fabrication and testing.<sup>72</sup> It is the plan of this office to establish a position at headquarters to review the configuration management system that presently operates across the National Space Transportation System. It is also a goal of the Associate Administrator to establish and improve lines of communication among the various NSTS elements in order to improve component integration and information interfacing among the various elements of the Shuttle.

The Committee is fully aware that faulty designs, improper fabrication techniques and component certification efforts can only be detected and identified through the implementation of proper quality control methods and procedures. The task of the NSTS program managers and the contractors is to assure that the quality is built into the design and production of Shuttle hardware. Nevertheless, the Committee also recognizes that the highest level of quality control methods and reliability engineering must be applied to all phases of the Shuttle production process, utilizing the latest state-of-the-art techniques of testing and analyses.

## 2. OPERATIONS

### a. Shuttle Processing Issues (including Spare Parts)

#### *Issue*

In 1983, NASA consolidated fifteen separate contracts and awarded a single Shuttle Processing Contract (SPC) encompassing all ground processing related to launch and landing of the Space Shuttle. There are two issues associated with this contract: (1) How sound is the concept of a unified SPC; and (2) How well has the SPC contractor actually performed? A related issue is the quality of essential logistical support, especially spare parts, provided to the contractor by NASA.

#### *Findings*

1. Performance under the SPC has improved since the inception of the contract. However, up to the time of the Challenger accident, contractor performance continued to be plagued by excessive overtime, persistent failures to follow prescribed work procedures, and inadequate logistical support from NASA.

2. High overtime rates have hampered SPC performance. Overtime rates had increased significantly during the six months prior

---

<sup>72</sup> Discussion with NASA officials, Washington, D.C., August 13, 1986.

to the Challenger launch, to the point that critical personnel were working weeks of consecutive workdays *and* multiple strings of 11- and 12-hour days. Fatigue resulting from work patterns of this sort can constitute a threat to safety. In fact, worker fatigue was a contributing factor in a mission-threatening incident on Flight 61-C, the mission immediately prior to the January 28 Challenger launch.

3. There are numerous documented cases when contractor employees failed to comply with guidelines for carrying out assigned duties, including specific "Operations and Maintenance Instructions" (OMI's). Such failures contributed to both of the major mishaps in 1985 involving Shuttle processing—namely, the November 8, 1985, "handling ring" episode which led to significant damage to a Solid Rocket Motor segment slated for use on STS51-L, and the March 8, 1985, "payload bay access platform" episode which led to significant damage to a payload bay door. Failure to follow an OMI also led to improper (and mission-threatening) handling of the hydrogen disconnect valve during the 51-L launch operations. All of these incidents show a lack of discipline, both with respect to following prescribed procedures and with respect to reporting violations of these procedures.

4. At the time of the Challenger accident, the lack of spare parts caused a degree of cannibalization (i.e., the removal of a part from one Orbiter to satisfy a need for a spare part on another Orbiter), which was the highest in the history of the Shuttle program and which was a threat to flight schedule and flight safety. Excessive cannibalization leads to multiple installations, retesting, added documentation, delayed access to parts, and increased damage potential. As a result, cannibalization contributes directly to excessive overtime.

5. There is no clear evidence whether or not greater involvement of the development contractors would improve Shuttle operations.

### *Recommendations*

1. Because of the serious quality and safety concerns surrounding the contract, NASA should conduct a careful review of Shuttle processing, the SPC contract, and the relationship of flight hardware contractors and report its findings, recommendations, and proposed contract modifications to the Committee. NASA's reexamination should include a comparison of efficiency and safety under the SPC versus efficiency and safety during pre-1983 Shuttle processing operations, which heavily involved the development contractors.

2. NASA should examine the issues of spares availability and cannibalization and provide the Congress with a management and budgetary plan for correcting previous logistical problems.

3. NASA should stop routine cannibalization and develop guidelines (including appropriate control and review procedures and roles for the SR&QA office) governing permissible cannibalization.

4. The Committee recommends that NASA provide its re-invigorated safety office with the authority to enforce scheduling that leads to safe overtime rates.

### Discussion

In a press release dated September 5, 1986, NASA announced that it has extended the SPC with Lockheed for three additional years, beginning October 1, 1986. Admiral Truly also announced his intent to conduct a thorough review of the SPC, a process which might lead to contract amendments.

Lockheed's award fees at the Kennedy Space Center have not been at the highest possible levels due to mishaps and management problems. The contractor has received the following award fees for Shuttle processing at KSC:

#### LOCKHEED SHUTTLE PROCESSING CONTRACT—AWARD FEE HISTORY

Period	From	Award fee available	Rating adjective	Rating score	Percent of maximum award fee earned	Award fee earned
First.....	Oct. 1, 1983 .....	\$6,618,880	Excellent .....	90.0	80	\$5,295,104
Second.....	Apr. 1, 1984 .....	1,299,404	Good .....	78.5	32	415,809
Third.....	Oct. 1, 1984 .....	1,308,554	Good .....	76.0	24	314,053
Fourth.....	Apr. 1, 1985 .....	1,308,554	Excellent .....	91.0	84	1,099,185
Fifth.....	Oct. 1, 1985 .....	1,308,554	Very good .....	89.0	76	994,501
Sixth.....	Apr. 1, 1986 .....	1,296,664	( <sup>1</sup> ) .....	( <sup>1</sup> )	( <sup>1</sup> )	( <sup>1</sup> )

<sup>1</sup> To be determined.

The rating scale runs from unacceptable to marginal, good, very good, excellent and superior. Two of the five ratings to date have been at the lower end of the scale.

At the time of the Challenger accident, Shuttle processing had suffered from inadequate spare parts for well over a year, and the problem was getting worse. The inventory of spare parts had run close to projections until the second quarter of fiscal year 1985. At that time, inventory requirements for spares began to increase faster than deliveries. A year later, the inventory should have been complete, but only 65 percent had been delivered.<sup>73</sup>

The number of cannibalized parts was increasing at an alarming rate. Forty-five out of almost 300 required parts were cannibalized for Challenger before Mission 51-L.<sup>74</sup> Eighty-five parts were cannibalized on 61-C, the mission preceding 51-L.<sup>75</sup> In fact, the number of cannibalized parts on each of these 1986 missions far exceeded the number of cannibalized parts on any previous mission. In 14 missions flown in 1984-1985, the average number of cannibalized parts was 14; in the 1986 mission, the number had increased nearly five-fold to 65.

The cause of the spare parts crisis was budgetary decisionmaking by NASA management. In October, 1985, the logistics funding requirements for the Orbiter program, as determined by Level III management at Johnson, were \$285.3 million, but that funding was reduced by \$83.3 million, necessitating major deferral of purchases of spares.<sup>76</sup> By the spring of 1986, the Shuttle logistics program

<sup>73</sup> Rogers Commission Report, Volume II, p. I-16.

<sup>74</sup> *Ibid.*

<sup>75</sup> Cmte Hgs, Transcript, July 16, 1986, p. 42.

<sup>76</sup> Rogers Commission Report, Volume I, p. 173.

was about one year behind; and under the proposed flight schedule, no Orbiters would have been available as spare parts bins.

NASA is well aware of the spare parts problem. In fact, during the Committee's hearings, Admiral Truly testified:

I can assure you that during our downtime we're going to take a hard look at it and make sure that the flight rates that we build up to after this accident are supportable by the logistics system that we have in place.<sup>77</sup>

The Committee received mixed reactions on whether development contractors need to be more involved in the SPC. Proponents of this approach argue that the current separation of responsibilities between the design organizations and the processing organization has created additional interfaces which make coordination, communication, and responsiveness more complex. Further, the processing contractor may not possess the necessary technical background to recognize either system degradation resulting from multiple missions or the criticality of the hardware being tested and processed.<sup>78</sup> The Rogers Commission report stated that the likelihood of improper Shuttle processing would probably be decreased if Rockwell, as overall development contractor, and Martin Marietta, who has a consulting role on the pre-launch processing of the External Tank, were subcontractors to Lockheed, as the other Shuttle development contractors are.<sup>79</sup>

At Committee hearings, contractors reacted predictably to proposed changes in the SPC. Development contractors, such as Rockwell and Martin Marietta, told the Committee that their organizations should be vested with beginning-to-end responsibility—design, development, manufacturing, operation, and refurbishment of their respective Shuttle element.<sup>80</sup> Lockheed, on the other hand, argued that there is already a very close relationship between itself and the development contractors. For example, there is one development engineer for every four Lockheed engineers. Development contractors participate in all meetings and are required to authorize and approve anything that is anomalous to the regular documented procedure.<sup>81</sup>

Ultimately, SPC performance will determine the proper balance of development contractors in the processing contract. NASA, in close consultation with the Congress, will need to make an impartial and ongoing assessment of comparative safety and performance under a consolidated versus unconsolidated SPC. Preliminary figures from NASA seem to indicate that Shuttle processing incidents have actually declined during the more recent consolidated-contract phase.<sup>82</sup> Further, it is likely that the fundamental problem to date with the SPC—overtime—would be exacerbated by the additional contractor coordination that would be required by greater inclusion of development contractors.

<sup>77</sup> Cmte Hgs, Transcript, July 11, 1986, p. 39.

<sup>78</sup> Rogers Commission Report, Volume II, p. K-32.

<sup>79</sup> Rogers Commission Report, Volume I, p. 195.

<sup>80</sup> Cmte Hgs, Transcript, July 15, 1986, p. 62.

<sup>81</sup> Cmte Hgs, Transcript, July 16, 1986, pp. 13-14.

<sup>82</sup> NASA, documents on the SPC contract, supplied to the Committee in July, 1986; Cmte Hgs, Transcript, July 16, 1986, p. 67, and Attachment C.

The responsibility for high overtime rates in the SPC must be shared by both NASA and the contractor. Mr. E.D. Sargent, President of Lockheed Space Operations Company, testified:

One of the problems that bothers us and drives us to overtime is either unplanned work or another form of unplanned work which is a hold or abort on the pad where we have critical skills that are required to perform functions.<sup>83</sup>

There is no doubt that late mission changes initiated by NASA are in large part responsible for Lockheed exceeding the five percent overtime target in the SPC contract.

But in fact overtime levels had grown from an initial SPC rate of 5.3 percent in April, 1984, to 13.9 percent in January, 1986—levels far in excess of what could be attributed solely to late mission changes. The peak monthly overtime level of 15.2 percent occurred in November, 1985. Although NASA managers at Kennedy attribute the November rate to the Thanksgiving holiday, the overall trend in overtime is undeniable—for each of the six months prior to the launch of STS 51-L, overtime exceeded 10 percent.<sup>84</sup>

More important that the average overtime rates was the overtime for certain employees with critical skills. Records show that there was a frequent pattern at Kennedy of combining weeks of consecutive workdays with multiple strings of 11- or 12-hour days. For example, one Lockheed mechanical technician team leader worked 60, 96.5, 94, and 80.8 hours per week in succession during the four weeks ending January 31, 1986.<sup>85</sup> While shiftwork is commonplace in many industrial settings, few can equal a Shuttle launch's potential for inducing pressure to work beyond reasonable overtime limits.

Research has shown that when overtime becomes excessive, worker efficiency decreases and the potential for human error rises. Noteworthy in this regard is Lockheed's review of 264 incidents that caused property damage in 1984 and 1985. More than 50 percent of these incidents were attributable to human error, including procedural deviations, miscommunications and safety violations.<sup>86</sup> On one occasion a potentially catastrophic error occurred just minutes before a scrubbed launch of Shuttle flight 61-C on January 6, 1986, when 18,000 pounds of liquid oxygen were inadvertently drained from the Shuttle's External Tank. The investigation which followed cited operator fatigue as one of the major factors contributing to this incident. The operators had been on duty at the console for eleven hours during the third day of working 12-hour night shifts. If the launch had not been held 31 seconds before lift off, the mission might not have achieved orbit.<sup>87</sup>

The adequacy of and adherence to Operations and Maintenance Instructions (OMI's) have been raised as areas of concern leading to quality and safety problems. Review of various SPC mishap reports and of the procedures leading to the launch of 51-L and earlier

<sup>83</sup> Cmte Hgs, Transcript, July 16, 1986, p. 24.

<sup>84</sup> NASA, documents on the SPC contract, supplied to the Committee in July, 1986.

<sup>85</sup> Rogers Commission Report, Volume II, pp. G-2-3.

<sup>86</sup> *Ibid.*, p. G-1.

<sup>87</sup> *Ibid.*

Shuttle flights highlight both the need for review and update of inadequate OMI's and the need for improved contractor performance in implementing adequate OMI's.<sup>88</sup> NASA's own review of flight 51-L showed several examples of improperly implemented procedures. The most serious error occurred when a console operator improperly closed the liquid hydrogen disconnect valve to the External Tank liquid hydrogen manifold. Although the valve appeared to function during 51-L, improper valve operation could have doomed 51-L just as surely as the failed rocket booster. As important as the failure to follow the OMI was the fact that the valve closure problem was never documented. Without proper documentation a full assessment of the problem was not made prior to launch of 51-L.<sup>89</sup> This lack of documentation is reminiscent of what occurred during "de-stacking" of Solid Rocket Motor segments from STS-9. Although destacking revealed water in the joints, this incident was never documented—an oversight which ultimately may have prevented an appreciation of the dangers of ice formation in booster joints during a cold-weather launch.<sup>90</sup>

#### b. Pressures on Shuttle Operations

##### *Issue*

Was NASA under pressure to fly more flights? How did this pressure originate? Will it recur?

##### *Findings*

1. The Congress and the Executive Branch jointly developed the policy that the Space Shuttle should, in a reliable fashion and at an internationally competitive cost, provide for most of the Free World's space launch needs. By and large, both Branches failed to appreciate the impact that this policy was having on the operational safety of the system.

2. NASA was under internal and external pressure to build its Shuttle flight rate to 24 per year, primarily to reduce costs per flight, but also to demonstrate and achieve routine access to space. NASA has never achieved its planned flight rate.

##### *Recommendations*

1. NASA must not attempt to achieve a flight rate beyond that which (i) can be supported by the budget and staff resources available; and (ii) is consistent with the technical maturity of the Shuttle and the flexibility desired and needed in scheduling payloads. Management should ensure efficient use of resources but should not impose a flight rate on the system.

2. Once operation of the Space Shuttle resumes, the Committee should maintain a close and continuous oversight of Shuttle flight rate, planning, and operations. The Committee should ensure both that flight rate flows logically from the resources provided and that flight safety is not compromised beyond acceptable limits.

<sup>88</sup> Kennedy Space Center Mishap Reports, No. 85-0070, April 5, 1985, and No. 86-0024, Dec. 13, 1985.

<sup>89</sup> Rogers Commission Report, Volume II, p. I-15.

<sup>90</sup> *Ibid.* p. I-14.

### Discussion

*Flight Rate.* The goal of the Shuttle program has been to become the Nation's primary space transportation system launching virtually all U.S. payloads and many foreign payloads, all at a reasonable price. Thus, there has been an explicit promise to deliver launch services.

Being a very complicated vehicle, the Shuttle demands a large trained workforce which must be retained between launches. In addition, there are the costs of maintaining large and complex launch facilities. Therefore, there is a large fixed cost in the Shuttle program of approximately \$1.2 billion per year. By comparison the additive or marginal cost for a single flight is around \$60 million (depending on how the accounting is done). Therefore, it is clear that (within limits) the cost-per-flight can be reduced by flying more flights, that is, by spreading the large fixed cost over more flights. However, it is also clear that the total cost—that is, the total amount of money that has to be appropriated—will increase as the number of flights increases because fixed costs are fixed and marginal costs must be added for each additional flight.

Therefore, to focus on cost-per-flight can be misleading. A lower cost-per-flight, achieved by flying more often, would allow a lower price to be charged to users, but does not lower the cost of the program. Because NASA had committed to lower the price to customers of Shuttle flights, there was a pressure to do this by increasing the flight rate. Nevertheless, NASA never achieved its planned flight rate.

For example, in 1976 NASA predicted 49 flights in fiscal 1984 and 58 in 1985. As late as August 15, 1983, 45 days before the start of fiscal year 1984, NASA planned 9 flights for fiscal 1984 and 12 for 1985. NASA actually flew four Shuttle flights in fiscal 1984 and 8 in 1985.<sup>91</sup> Of course management worked hard to reduce this gap between plans and performance.

The emphasis on reducing costs per flight and delivering launch services has caused a very basic and pervasive pressure to increase the flight rate in the Shuttle program. This is well documented in Chapter VIII of the Rogers Commission report.<sup>92</sup>

Presumably, the Challenger accident has changed this situation. Recommendation VIII of the Rogers Commission states in part that "NASA must establish a flight rate that is consistent with its resources."<sup>93</sup> NASA's response to this recommendation hints that this may not be the case. NASA speaks of determining "the maximum achievable safe flight rate."<sup>94</sup> Such a flight rate would again leave no "margin in the system to accommodate unforeseen hardware problems" as the Commission found was the case before the accident.<sup>95</sup> The NASA response makes it clear that the flight rate

<sup>91</sup> Hearings before the House Committee on Science and Technology, FY 1978 NASA Authorization, September 14, 1976, Volume I, Part 1, p. 394; NASA, "Space Shuttle Payload Flight Assignments," August 15, 1983. NASA; "Space Shuttle Payload Flight Assignments," November, 1985.

<sup>92</sup> Rogers Commission Report, Volume I, pp. 164-77.

<sup>93</sup> *Ibid.*, p. 201.

<sup>94</sup> NASA Response to Rogers Commission, July 14, 1986, pp. 30-31.

<sup>95</sup> Rogers Commission Report, Volume I, p. 177.



will be determine based on studies and that "program enhancements . . . *required to achieve the flight rate*" will be implemented [emphasis added].<sup>96</sup> This is reinforced in the NASA response to Recommendation IX where NASA says "NASA has initiated an assessment of spare parts requirements *to adequately support the flight rate planning.*" [emphasis added]<sup>97</sup> Thus, it seems that once again a planned flight rate could become a controlling factor.

A finding of the Pre-Launch Activities Team is that during the preparation of 51-L for launch "Manpower limitations due to high workload created scheduling difficulties and contributed to operational problems."<sup>98</sup> This is perhaps one of the clearest examples of the inappropriate logic at work in the system before the accident, because "manpower limitations" are *not* due to "high workload" in the system. Manpower and other resources are limited before the workload is planned. Problems are created when the workload assigned is inappropriate to the manpower available.

In a March 24, 1986, memorandum on "Strategy for Safely Returning the Space Shuttle to Flight Status," Admiral Truly reveals a better attitude toward flight rate in speaking of a "realistic and . . . achievable launch rate that will be safely sustainable." Admiral Truly also states that "the ultimate safe sustainable flight rate and the build up to that rate will be developed utilizing a 'bottoms up' approach in which all required work for the standard flow . . . is identified and that work is optimized in relation to the available work force."<sup>99</sup>

NASA prepared several reports for the Rogers Commission, and the Mission Planning and Operations Team (MPOT) Report indicates a good awareness of the general problem of over-ambitious flight rate planning. For example, that report states that compared to the need to devote resources to making the transition to an operational system the "increasing flight rate had the highest priority." The MPOT report continues, "In other words, it appears that the flight rate was not tied to the ability of the system to support it, but rather the system was reacting to the established flight rate." A major conclusion of the MPOT report is that "The NSTS Program should develop a bottoms-up strategy for expanding flight rate."<sup>100</sup> In other words, flight rate cannot be imposed from above, but must be determined by available resources.

The disturbing fact is the trend in the NASA statements. The earlier statements (i.e., the Truly memo and the MPOT report) indicated an awareness of the danger of trying to achieve an imposed flight rate. However, as mentioned above, the most recent statement, the NASA response to the Commission, once again speaks of achieving the planned flight rate.

The Rogers Commission has documented the fact that before the Challenger accident the Shuttle system was approaching a state of saturation in which no more flights could be accommodated. If the accident had not occurred flight rate saturation may have eventually been reached due to bottlenecks in crew training on the mis-

<sup>96</sup> NASA Response to Rogers Commission, July 14, 1986, p. 31.

<sup>97</sup> *Ibid.*, p. 33.

<sup>98</sup> Rogers Commission Report, Volume II, p. I-14.

<sup>99</sup> NASA Response to Rogers commission, July 14, 1986, p. 40.

<sup>100</sup> Rogers Commission Report, Volume II, p. J-31.

sion simulators<sup>101</sup> or because of inadequate spare parts for the Orbiter.<sup>102</sup>

Availability of training time on simulators and availability of spare parts can both be improved by the application of more resources. Nevertheless, if the achievement of a planned flight rate is the overriding concern, removal of one bottleneck may only reveal another one. Eventually, pressures will be brought to bear on safety. The pressure on NASA to increase Shuttle flight rate has been complicated by the need to maintain program flexibility (which means to accommodate changes in the payloads on the manifest) and by the "developmental" nature of the Shuttle system. Manifest changes and the developmental nature of the system create problems in the planning of Shuttle missions.

In addition, it is interesting to note that until the training, spares, and mission planning problems are resolved, achievable flight rate may not depend on whether or not Challenger is replaced.

### c. Impact of Pressures on Shuttle Operations

#### *Issue*

Did operating pressures adversely affect the safety of the Shuttle program?

#### *Findings*

1. The pressure on NASA to achieve planned flight rates was so pervasive that it undoubtedly adversely affected attitudes regarding safety.

2. The pressure to achieve planned flight rates was compressing mission preparation as earlier missions were delayed due to unforeseen problems. Had the accident not occurred there would soon have been a collision between planned launch dates and mission preparation needs which could not have been met by overtime, cannibalization, or other undesirable practices. Operating pressures were causing an increase in unsafe practices.

3. The schedule of payloads planned to fly on the Shuttle (the manifest) was frequently changed. Each change rippled through the NASA Shuttle organization and through the manifest and, especially if made shortly before launch, would increase the demands on personnel and resources in order to achieve the planned flight rate.

4. The Space Shuttle has not yet reached a level of maturity which could be called operational as that term is used in either the airline industry or the military. Each Shuttle flight is fundamentally unique, and requires unique preparations. Therefore, small changes in a mission can cause significant perturbations of mission planning and crew training.

#### *Recommendations*

1. The new Associate Administrator for Safety, Reliability and Quality Assurance must assure that any pressures to increase the

<sup>101</sup> *Ibid.*, Volume I, p. 170.

<sup>102</sup> *Ibid.*, p. 174.

Shuttle flight rate do not adversely influence mission preparation. The Associate Administrator must have the authority not only to stop a particular flight, e.g., at a Flight Readiness Review, but to stop the whole mission planning process if necessary.

2. Where appropriate, NASA should take steps to make the mission planning process standard and routine to reduce the time and resources needed to plan a mission. Before requesting more resources for the existing mission planning process (manpower, facilities, equipment) NASA should identify ways to improve the process.

### *Discussion*

There is no doubt that operating pressures created an atmosphere which allowed the accident on 51-L to happen. Without operating pressures the program might have been stopped months before the accident to redesign or at least understand the SRB joint. Without operating pressure the flight could have been stopped the night of January 27. This is documented in the Rogers Commission report in Chapters V and VI.<sup>103</sup> Specific manifestations of launch pressure and the resultant atmosphere in the agency are described in detail in Section VIII of this report.

Nevertheless, it has become clear that the Shuttle launch system was not functioning well and was becoming increasingly unsafe as flight rate was increased. This is documented in Chapter VIII of the Rogers Commission report.<sup>104</sup>

*Mission Planning.*—Mission planning refers to the process of defining and preparing each Space Shuttle mission. It is important to understand the mission planning process in order to understand why pressure to achieve a given flight rate could have adverse impacts. The process is lengthy, complex, and tightly interrelated. That is, many steps must be done in sequence, and many different flights have to use limited resources and facilities.

Mission planning begins at NASA headquarters with the customer services manager in the Office of Space Flight. Both financial and policy agreements between NASA and the customer are negotiated and signed. Technical documentation begins at this time although the level of mission-specific work is low.

After flight assignments are made by NASA Headquarters and the mission is defined, a process of continual review begins. Payloads are assigned to a particular flight 33 months prior to launch. At this time a Payload Integration Plan (PIP) is developed which includes a preliminary analysis of the mission.

Payload safety is the responsibility of the payload developer. He must be thoroughly familiar with NASA safety requirements and must certify that his payload meets them. NASA audits the certification process but performs no visual inspection of the payload for conformance to safety standards.

Once the cargo of a particular mission has been defined, or "baselined", the significant engineering work of mission processing actually begins. NASA refers to this as the "production process". The product of the process is the launch of a particular mission,

<sup>103</sup> *Ibid.*, pp. 82-151.

<sup>104</sup> *Ibid.*, pp. 164-77.

but there are many other intermediate products such as flight and training software, crew activity plans, and handbooks and checklists for the crew to take on the flight.

The launch production process template is displayed schematically on Figure VI-2. The template begins 15 months before the scheduled launch date (L-15), at which time a Flight Definition and Requirements Directive (FDRD) is issued. This marks one of seven defined "freeze points" of the 15 month mission-specific pre-launch activity. A freeze point simply means that a particular activity is norminally defined so that no time changes can occur without a formal process to authorize and document the change. In theory, non-mandatory changes are not made after a freeze point. As noted below, significant changes do indeed occur after the various freeze points in the schedule.

# GENERIC TEMPLATE (CIR 7.7 MO)

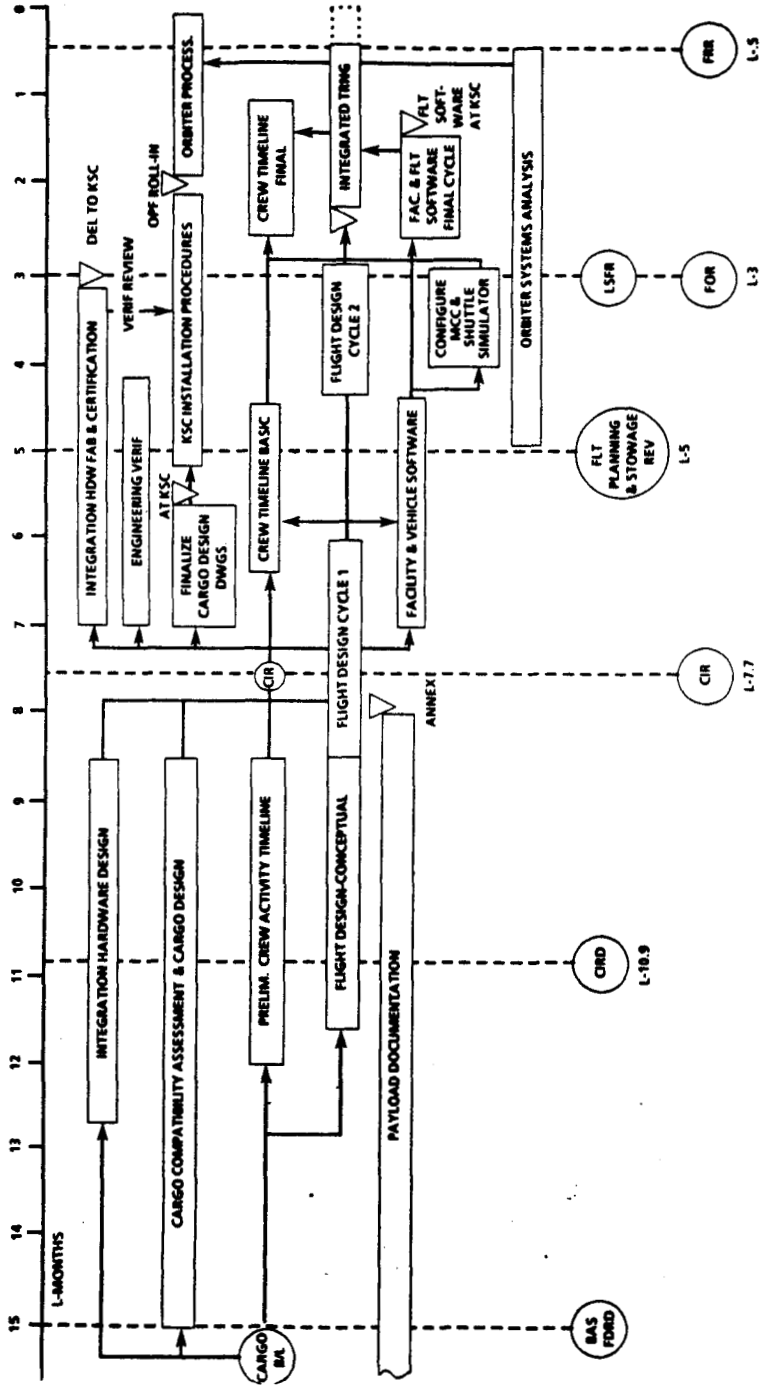

FIGURE VI-2

At 7.7 months before launch, the Cargo Integration Review (CIR) occurs. This is a critical point in the mission definition and launch process. The customer participates in this review. All baseline requirements for flight design, flight and ground operations, and crew size are defined. The engineering requirements for a particular mission are approved. The CIR essentially separates the design process and concept documentation from the actual Orbiter processing, installation and certification of the hardware and software, and final crew training and engineering verification of the various systems on the Orbiter. Typically 10 to 20 percent of the mission-specific preparation work is accomplished by the time of the CIR, and after the CIR the process is driven by the Shuttle mission preparation milestones.

At L-3 months the flight operations review (FOR) takes place. This freeze point allows the customer to review all final flight operations plans. At approximately the same time the launch site flow review (LSFR) takes place, at which the timing and flow of the Shuttle and its cargo through the Orbiter processing facility (OPF), the vehicle assembly building (VAB), and to the launch pad are all reviewed and baselined. No changes should occur after this point in time, but, of course, some do.

At L-2 weeks the Flight Readiness Review (FRR) takes place. Its purpose is to verify the fact that for this mission the hardware and software are ready for flight. It is here that the final commitment to a specific launch date and time is made.

At the FOR typically 40 to 50 percent of the work of the production process has been accomplished. At the time of the Flight Readiness Review, almost all of the work must have been accomplished because the Flight Readiness Review is not for the purpose of working out problems but merely to certify that problems have been resolved.

As the targeted flight date approaches, conditions are continually reviewed and last minute changes are made as necessary through a series of meetings and teleconferences.

This simplified description does not begin to reveal the details of the launch production process but study of the template should give some indication of its complexity. With over 50 percent of the work typically needing to be accomplished in the last three months before launch, and with typically 20 or more flights in work at any given time, it should be clear that last minute changes can be very disruptive and costly.

The developmental or non-operational status of the Shuttle also contributed to problems as the flight rate increased. Less time between flights meant that results from one flight could not be incorporated into the early planning for the next one. In other words, any change resulting from feedback from the previous flight was necessarily a last-minute change. Because of the developmental nature of the Shuttle system, such changes were to be expected. At 24 flights a year there would be about two weeks between flights. Allowing some time for flight data analysis, this would mean that results of the previous flight typically would not be available at the Flight Readiness Review. Indeed, the O-ring erosion results of flight 61-C were available only immediately before the 51-L launch.

The complex and lengthy mission planning process was under increasing pressure and was being strained to achieve the planned launch rate. Two activities that were compressed were training of the flight crew and training of the ground launch crew.

*Training.*—When training and other preparations is compressed, program quality is likely to suffer, and errors become more likely. Given the situation with NASA's safety program—which the Rogers Commission described as “silent”—errors were less likely to be detected before harm could occur. Errors can be caused by personnel taking shortcuts with respect to established procedures. Two examples are given in the Pre-Launch Activities Team report:

The most significant error encountered was during the launch countdown. While preparing for propellant loading, the LH2 Orbiter to ET disconnect Valve was opened by the console operator. He had erroneously failed to follow the required steps in the OMI. A follow-on error was made in that this occurrence was not properly documented. Since proper documentation was not present, a full assessment of the problem was not made prior to the launch of STS 51-L. Flight data from STS 51-L indicated the valve did perform satisfactorily.

Another major error occurred when the integrity seals on the ET aft restraints were broken and not reported. It is believed that the seals were broken in error, but the break of integrity was not reported in accordance with established procedures.

The underlying factors contributing to these errors were not determined during the processing reviews.<sup>105</sup>

These errors apparently had no adverse impact on the mission, but indicate a breakdown of the discipline so necessary for a process as complex as launching a Shuttle.

Shuttle crew training is an important part of mission preparation. The crew of 51-L had training loads as high as 70, 63, 65, 59 and 58 hours in the several weeks before their launch. This was due to the fact that their training started some 3 weeks later than scheduled.

It must be noted that the crew also had 3 easy weeks during this period. During the weeks which included Thanksgiving, Christmas and New Year's they only trained 31, 27 and 49 hours, respectively. No harmful effects of compressed Shuttle crew training have been documented but common sense indicates that the situation must have been less than optimal.

It will be recalled that the launch of flight 61-C, which immediately preceded 51-L, was delayed several times. It was originally scheduled to launch on December 18th and eventually launched on January 6th. The Commission report describes how the launch date slips for 61-C became a scheduling factor for the training through integrated simulations for 51-L.<sup>106</sup> Delay of 61-C launch pushed a bow wave of tests at the Kennedy Space Center which required 51-L prime crew and/or mission control center resources and thereby

<sup>105</sup> Rogers Commission Report, Volume II, p. I-15.

<sup>106</sup> *Ibid.*, p. J-13.

constrained the time at which integrated simulation training could be conducted. The 51-L training schedule was changed several times during the last weeks prior to launch due to launch slips of 61-C and the desire to suspend work between the Christmas and the New Year holidays. Eventually all 51-L training was accomplished with some change of spacing between the simulations. If the originally planned spacing of simulation training was optimum, then the changed spacing probably was not.

It is not clear exactly why the 51-L crew was late in starting its training, because it should have started training before the delays of the 61-C launch began. What is clear is that the crew training is a serial effort which cannot occur until software is available to drive the simulation computers.<sup>107</sup> The necessary software cannot be written until the specific flight configuration of the mission has been designed. This is a situation in which each event must wait on the completion of the previous one. In the case of 51-L there were delays and development of some software elements. But it is not clear that the development of these elements was in fact started on time. It is clear that there was considerable remanifesting of 51-L, for example during most of 1984 the Cargo Integration Review was scheduled to occur on September 4 but due to remanifesting this slipped and the CIR eventually occurred on June 18, 1985. In April 1985 a major change was made when the Orbiter assigned to the mission was changed (from OV-104 to OV-099) and major payload changes were made. This caused a slip of launch date from November, 1985, to January, 1986. There were small middeck payload changes in October, November and December of 1985.<sup>108</sup>

It is clear that these changes must have delayed the delivery of software which, in turn would delay the start of crew training. Crew training was not related to the accident, but it does seem clear that the system was breaking down (i.e., data presented in the Commission report shows that in January of 1986 the delays in the projected start of crew training were growing).<sup>109</sup>

Examination of the record shows that pressure to achieve the planned flight rate was forcing the crew to train later and later, which meant higher weekly training loads. This was very likely compromising the effectiveness of the crew training and thus the safety of the missions, although no harm had been documented at the time of the accident.

*Manifest Changes*—As described in detail above, the planning of a Shuttle mission requires more than a year of significant work, with the first major “freeze point” occurring 15 months before planned launch. A freeze point is a place in the mission planning schedule where decisions are made about the mission and its implementations. In theory, these decisions are made in a cumulative fashion so that earlier decisions do not have to be changed as the mission is refined through the planning process. Indeed, if there are no changes, this is in fact the way the system works; however, there are changes.

---

<sup>107</sup> *Ibid.*, p. J-38.

<sup>108</sup> *Ibid.*, pp. J-7-12.

<sup>109</sup> *Ibid.*, p. J-42.



The first freeze point occurs when the mission is officially defined and payloads are assigned to a specific Orbiter. Another major freeze point occurs approximately seven months before launch at the Cargo Intergration Review (CIR). Typically, more than 80 percent of the work necessary to prepare a mission occurs after the Cargo Integration Review. Changes in the mission after the CIR tend to be much more expensive than changes made earlier in the process.<sup>110</sup> The Rogers Commission has adequately documented the fact that changes to the Shuttle manifest were common and major.<sup>111</sup> As of April, 1986, the six missions planned to follow flight 51-L which were not dedicated missions, i.e., not missions having only one customer, had a total of 30 changes or an average of five each after the start of the production process. Eleven of these changes were major that is, they involved the exchange of different types of major payloads.<sup>112</sup>

Manifest changes can be divided into four basic categories depending on the origin of the change. Some changes are caused by hardware problems such as when the Tracking and Data Relay Satellite was found to have a problem and was deleted from flight 51-E. As there is no reason to launch a faulty satellite, NASA virtually is obligated to allow such faulty satellites to be changed out.

The second category of manifest change results from what could be called "customer request." For example, many communication satellites have been rescheduled at the customer's request for business reasons. Again, NASA is in an awkward position because if the satellite is not needed, NASA would not want to be in the position of insisting that it be launched. (Although there have been cases when customers launched satellites and stored them on-orbit.)

A third category is caused by the belated recognition of operational constraints in the Shuttle system. For example, it has been found that a payload combination would exceed the landing weights for the transatlantic abort sites.

In another example of this type of change, it was found that there was no acceptable launch window for a planned combination of payloads which needed to be put in different orbits. It would seem that NASA could improve its mission planning production process to minimize this kind of manifest change by doing a better job of assessing the impact of operational constraints on payload combinations earlier in the planning process. Of course, one must allow for the late emergence of subtle operational constraints which would only be discovered as a result of deep analysis relatively late in the process. Nevertheless the MPOT report suggests that NASA sometimes carries unworkable flights on the manifest.<sup>113</sup>

The fourth category of manifest change is due to external factors, many of which are totally within NASA's power to deny. It appears that many of the Headquarters requests for changes are made in order to put on the manifest science experiments which

<sup>110</sup> NASA briefing on STS Production Process by Elaine Hofstetler—Presented to Committee Staff on May 19, 1986.

<sup>111</sup> Rogers Commission Report, Volume I, pp. 166-73; Volume II, pp. J-26-29, J-33-51.

<sup>112</sup> NASA briefing, May 19, 1986.

<sup>113</sup> Rogers Commission Report, Volume II, p. J-46.

are essentially payloads of opportunity. This would include the Get Away Specials (or GAS-cans). It has been considered highly desirable to give this kind of standby status to scientific experiments because they have had low priority on the manifest. That is, it is a way for such experiments to get a relatively early flight.

When changes are made in the manifest they tend to ripple through the system and affect not only the mission in work but also all the other missions in work. For example, changes mean rework—things need to be done over. Software for the mission may have to be rewritten. Inevitably, this causes some delay and compresses the time available for other work scheduled downstream in the process if the launch date is to be maintained. Of course, if the flight rate is to be achieved, launch dates must be kept.

Other missions are affected because the reworks necessary as a result of changes will pull engineers and technicians away from other projects. For example, in January, 1986, there were 21 flights in process. Given the fact that that resources available were finite, more work on one mission means that other missions have to wait. The result is that the mission preparations for the other missions also are compressed as they wait for the preceding mission to clear the process. The world system becomes less and less resilient, there is more and more overtime, and there is temptation to take shortcuts in the process.

It is important to note that “manifest changes” can also be viewed as “payload flexibility” as in the case of the “GAS-cans” mentioned above. Therefore, there may be a need to decide more specifically what we intend the Shuttle system to accomplish. If maximizing flight rate is to be the overriding consideration, then flexibility will have to suffer. However, if NASA adopts to rigid a posture with regard to payload changes, customers or users may object. For example, as pointed out above, there is no point in launching a faulty satellite. Most space operations are simply not mature enough for NASA to enforce a rigid manifest.

It would seem that a better way to minimize the adverse impacts of manifest changes would be to simplify the mission planning process so that freeze points could be later, that is nearer to the launch date, so that consequently changes would occur relatively earlier in the process, therefore with less impact.

Given the history of the program, it is known that there will be changes in the manifest and that the impact of these changes will be serious. It does not seem, therefore, that it would be particularly fruitful to try to develop analytical management tools to predict the impact of changes in the existing system (an effort NASA has suggested). Rather, effort should be directed toward developing a new, improved mission planning system. Also, the MPOT report claims that the impact of changes is already predictable, and can be budgeted.<sup>114</sup>

*Operational Status of the System.*—In addition to reconsidering the priority which should be attached to maximizing flight rate, there is also a need to consider the degree to which the Shuttle itself can be made more “operational.”

---

<sup>114</sup> Ibid., p. J-38.

The Rogers Commission Report makes much of the fact that the Shuttle is not operational.<sup>115</sup> The same point was made strongly to Committee staff in interviews with personnel at Kennedy Space Center involved in launch processing. The Roger Commission made no recommendation on this matter and NASA in its reponse to the Commission has not directly commented on it.

As early as 1981, senior NASA officials agreed that the Shuttle should be brought "to a cost-effective operational status" and that to that end Shuttle design should be "frozen".<sup>116</sup>

The Shuttle was declared operational after its fourth flight, but that the program clearly was not capable of functioning in a manner that would be called operational in any other milieu. Each Shuttle flight is, indeed, unique. Large amounts of software must be written *de novo* for each flight. This is appropriate for a developmental program but clearly but clearly will not work as NASA tries to move into a truly operational phase.

Prior to the Challenger accident NASA had realized that the mission planning process had to be drastically improved, probably through standardization. Unfortunately, pressure to increase the flight rate was driving all available resources into speeding up the existing system. There simply were not resources available to analyze the mission planning system and see where it could be simplified.<sup>117</sup>

If the Shuttle is to fly routinely, the mission planning system must be reworked to that end. For example, the Commission report makes the point that the two flight simulators were a bottleneck in the astronaut training process.<sup>118</sup> Undoubtedly this was true. What is not clear is whether there is another way. For example, would it be possible to develop specialized crews, say a group of astronauts trained to deploy communication satellites, who would need much less training to repeat identical or similar missions, thus reducing the demands on the simulators? The point is not that such savings must be found or can be found, but that they must be sought and resources must be dedicated to the search for such savings. If, indeed, no such standardization of mission planning is possible, NASA must face up to this fact and operate the Shuttle accordingly. As mentioned above, there are disturbing signs that NASA is moving once again toward achieving the highest possible flight rate without fundamentally changing its approach to Shuttle operations.

*Pressure to Reduce Cost and Turn-around Time.*—NASA was under pressure to reduce flight costs and to reduce turn-around time between flights. In some cases they could achieve both objectives at once by eliminating work done between flights (e.g., testing and refurbishment). A NASA memo shows that such actions were being pursued as early as August, 1981, after only one Shuttle

<sup>115</sup> *Ibid.*, Volume I, p. 170-71.

<sup>116</sup> Memo from W. R. Lucas, Director, Marshall Space Flight Center, to James M. Beggs, Administrator, dated August 21, 1981; subject: "ET/SRB Productibility/Cost Reduction"; the relevant sentence reads: "I wholeheartedly agree with your statements that Shuttle performance requirements and design should be frozen so that we can concentrate all efforts on bringing the system to a cost-effective operational status."

<sup>117</sup> Rogers Commission Report, Volume II, p. J-31

<sup>118</sup> *Ibid.*, Volume I, p. 170.

flight.<sup>119</sup> Attached to the memo are lists of activities to improve the producibility and reduce the cost of the SRB and ET. These include reduction of "mandatory government inspection requirements" for SRM processing by Thiokol and reduction of SRM propellant verification testing.

The point is not that these particular actions were unsafe, but that even very early in the flight program there were pressures on testing and inspection activities in the program.

*Shuttle Process Issues.*—Section VI.A.2.a. of this report, on "Shuttle Processing Issues" discusses several matters such as the availability of spares, overtime, and the adequacy of OMIs. It is clear that operating pressure aggravated and issues discussed there. For example, had there been no operating pressure there would have been less pressure on spares, less overtime, and more time either to revise OMIs or to execute them.

*Change Control Process.*—Section VI.B.1.d. on "Change Control Process" discusses how the pressure to increase flight rate compromised the hardware change control process. An important factor is the developmental (i.e., not-yet-operational) nature of the Shuttle System which means that large numbers of significant hardware changes can be expected.

#### d. Other Safety Issues

##### *Issue 1*

What is the criticality of landing safety associated with programmed and abort landing sites and their local characteristics?

##### *Findings*

1. The Committee finds that many of the normal and abort landing safety problems will be alleviated when the Rogers Commission's and the Committee's (section V.A.1.b., this report) recommendations to upgrade the landing gear system are implemented. When the landing gear system is understood, straightforward calculations and operational rules will determine acceptable runway dimensions and conditions.

2. The Committee found no reason to fault NASA's current procedure on launch constraints based upon operational judgement and conservative rules on local conditions at planned abort and landing sites. However, since an obvious finding is that the Orbiter is a developmental system, it is axiomatic that unanticipated "dicey" circumstances will arise.

3. It was found that for the least landing gear system stress, runway preference is Edwards Air Force Base (EAFB) (concrete), KSC, and Rogers Dry Lake (EAFB "lake bed") in that order. No reason was found to invalidate the KSC runway design. The reasons for the "dry" course surface still prevail over concern about wear on tires designed for one landing. Additional constraints at KSC because of lesser lateral stabilized overrun area may be needed to bring its safety to the level of the EAFB runway.

4. The NASA Landing Safety Team's proposal to provide standard landing aids and arresting barriers at all sites and their em-

<sup>119</sup> NASA Memo from W.R. Lucas, to James M. Beggs, Administrator, dated August 21, 1981.

phasis on runway surface characteristics for repetitive tire use takes on a new dimension that is in addition to the Rogers Commission's recommendations.

5. Weather, by far, is the most significant factor governing operational decisions, Orbiter damage, and landing safety. The constraint is simply that acceptable weather must be forecast with confidence within the time frame needed. Ultra-conservative rules prevail because of the predictable unpredictability of Cape weather. New and innovative local weather analysis and forecasting research is a high priority. The African Coast and southwestern United States sites enjoy more stable and predictable weather.

### *Recommendations*

The first priority to achieve an acceptable degree of landing safety and to have a sensible base to work from for improvement is to implement the recommendations of the Rogers Commission and the Committee on the landing gear system improvement to attain an operational capability. Then:

Instrument the system, and schedule all landings at Edwards runway for systematic concurrent testing until the landing gear system is understood.

Write a clean sheet set of rules based on results.

Determine the risk of accident with the B-747 Shuttle Carrier Aircraft (SCA) and its impact upon the Shuttle program.

Extend every reasonable effort to assure a mission planning process to minimize the need for abort site landings.

Reevaluate and determine the degree of risk acceptable at abort site landings and bring abort site capability up to meet that risk level.

Expand astronaut matched team flight landing practice to cover all known exigencies. Propose additional training craft if necessary.

Join in a venture with NOAA to invent new technology and techniques to learn new ways to understand the dynamics of Cape Kennedy weather phenomena to supplant current inadequacy to forecast two hours ahead.

### *Discussion*

This discussion assumes that landing gear system improvements are to be implemented. The substance of the testimony and results of the Committee investigation are fairly clear.

The EAFB runway will remain the primary programmed landing site for the duration of the Shuttle program simply because of the capricious nature of the Cape weather. All landing parameters favor Edwards runway as the best for safety and it approaches 100 percent predictable availability.

The safety of Rogers dry lake is permanently compromised because of the lake bed surface. Its firmness and surface strength are variable and the surface has considerable debris scattered on it. Should the tires blow on one strut, it would dig in and the Orbiter would not be controllable as it would be on a concrete runway with nose wheel steering and brakes. This is also true of stabilized lateral and longitudinal overrun areas of the concrete runway.

From the body of testimony, it can be deduced that given a landing gear system that meets operational requirements, acceptable weather, and an adequately trained pilot, the Orbiter can consistently achieve the acceptable level of low risk landings that was originally intended at Edwards and KSC. The worst KSC case is the heavy weight abort Return To Launch Site (RTL) landing. Night landings at these sites add an element of risk that cannot be evaluated until day landing confidence is restored. The only astronaut testimony on night landings was not favorable.<sup>120</sup>

Landing safety at remote abort sites presents, by far, the worst case including all facets of navigation, weather, energy management, depth of pilot training, other air traffic intrusion, alignment, approach, heavy weight high speed landing, narrow and short runways, and fire and rescue support, and perhaps even terrorism or sabotage. In short, the classical emergency landing is just that—an emergency landing. It will surely test the skill of the pilot. The only sure cure for abort landing exposure is a successful launch.

Testimony gave reference to one RTL site (KSC), five TAL (Trans Atlantic or Trans Abort Site) sites (Casablanca, Dakar, Moron, Rota, Zaragoza), and three AOA (Abort Once Around) sites (EAFB, White Sands Northrop, KSC). At least one each of these must be available within the rules of visibility, wind, dew point, precipitation, ceiling, cloud cover, turbulence, and gusts, and provide TACAN, MLS, PAPI (Precision Approach Path Indicators), and Ball Bar lights as deemed necessary for the mission; the RTL within 25 minutes of launch, the TAL at about 35 minutes, and the AOA in an hour and 45 minutes.

The Orbiter is not a good handling airplane to fly. The Orbiter landing is the most demanding task of airmanship expected of an aviator today. It is a complex and sophisticated blend of automation, systems management, and manual skills:

The Orbiter re-enters with a 1100 mile cross track capability to begin the Terminal Area Management phase, 52 miles out at Mach 2.5 and 82,000 feet.

Computer energy management delivers the Orbiter to the alignment circle on TACAN where the pilot takes over at three minutes out on a 19 degree glide slope aligning on PAPI lights.

At 13,000 feet, 6 miles and two minutes out, he initiates flare to intercept the 1.5 degree glide slope at 275 knots.

Guiding on the Ball Bar lights, he approaches and lands around 200 knots depending on his weight.

At 140 to 120 knots, he begins to brake and decelerates to a stop.

If MLS terminal navigation is not available, the pilot can rely upon onboard radar for precision altitude and use his heads up display to assist what is nominally a visual approach and landing. There is no room for computer, navigation or pilot error. Training aircraft training and practice is an element of major importance to successful Orbiter landings under the variety of conditions facing the pilots. Unrationed crew team flight training is deemed essen-

<sup>120</sup> Rogers Commission Report, Volume V, p. 1455.

tial to landing safety. Conversely, suggested autoland systems for this application did not find much support because they would pose a whole new development and certification hazard.

Landing safety will make a lot more sense if and when the cloud of imminent landing gear system failure is dissipated. That has been a pervasive note through the entire testimony and investigation.

### *Issue 2*

Has adequate provision been made for crew safety in case of in-flight emergencies? That is, has adequate provision been given to launch abort options and crew escape options?

### *Findings*

1. Crew escape options were considered when the Shuttle was originally designed and the basic situation has not changed. Many initially attractive options do not significantly reduce risk to the crew either because they may not reduce exposure to the principal hazards or because they add risks of their own.

2. A crew escape system for use in controlled gliding flight might be feasible and worthwhile.

3. Crew escape during the ascent phase appears infeasible.

4. Launch abort during SRB burn appears impossible but it may be possible to decrease risk to the crew after SRB separation, primarily through mission design.

### *Recommendation*

NASA should continue to respond to the recommendations of the Rogers Commission regarding (i) crew escape during controlled gliding flight and (ii) increasing the possibility of successful emergency runway landings. NASA should re-examine all crew survival options and report to the Committee on its findings.

### *Discussion*

Before addressing the particulars of the findings and recommendations regarding launch abort and crew escape a few general comments on safety and risk will establish a useful framework.

Any new safety equipment installed on the Orbiter will bring with it its own new risks. It will also add weight to the Orbiter and will have associated capital and operating costs. Each of these must be addressed.

*New Risks.*—Consider for example the possibility of adding ejection seats to the Orbiter. The United States Air Force experience with ejection seats has been that they are only about 80 percent effective.<sup>121</sup> The point is that ejection seats are not a panacea. Any safety equipment has a chance of failing; ejection seats in particular always have a potential of premature activation which would result in the crew being ejected when there is no need.

*Additional Weight.*—In order to accomplish its purpose, the Shuttle must put payloads, i.e., weight, in orbit. Adding weight to

<sup>121</sup> Briefing to Committee Staff, May 28, 1986, "Report of the First Stage Abort Options History Task Group Chartered by the Mission Planning and Operations Team"—Barney Roberts, Advanced Programs Office, Johnson Space Center.

the Orbiter reduces the payload weight that can be orbited and therefore reduces the justification for the program. This is perhaps made clearer by considering a *reductio ad absurdum*. Suppose one could develop a new escape system—perhaps an ejection pod which could reduce risks to the crew by 90 percent but weighed approximately 65,000 pounds. Since the Shuttle payload capability is only about 65,000 pounds there would be no remaining payload capacity in the Shuttle, and some risk would still remain. There would be no point to installing such a system because it would be a very bad trade. Evidently, one must do an engineering cost-benefit calculation and decide if the benefit is worth the penalty for each proposed change.

*New Costs.*—The same type of cost-benefit calculation must be done in the financial dimension. It is important to emphasize that the question is not “how much is a life worth?,” but rather “where can an extra amount of funding best be spent to reduce total risk to the crew, the mission, and the Orbiter?”

Risks will never be zero—what NASA must do is to better understand the risks and minimize the most dangerous exposures.

The risk, cost and weight penalties of crew escape systems that could hope to operate effectively while the SRB are thrusting are very large. This dictates that it is much more efficient to put program resources into reducing risks by improving the reliability of the SRB's and the whole Shuttle system during the period of time that the SRB's are thrusting. For example, if one of the SRB's should develop a problem so that there was a need to separate the Orbiter from the SRB's and External Tank, it is essentially impossible to do this successfully while the SRB's are still thrusting. There are potential means of terminating SRB thrust which amount to explosively opening holes in the rocket casing. The holes allow the burning gases to exit the casing at several places so that there is no net thrust. Such a mechanism has the potential of premature activation which could lead to loss of the crew and the mission. In addition, the resulting deceleration loads on the Orbiter would require significant redesign, if the Orbiter were to survive.<sup>122</sup>

A large part of the problem is that the launch situation is very dynamic. Decisions and implementation of decisions must be made very rapidly. The decisions are binary; that is, either “go” or “no-go,” and the implementation must be largely automated for speed of execution. Thus, if a premature activation begins it will almost certainly go to completion.

In the case of 51-L accident, the first ambiguous indication of a problem came at about 65 seconds into the mission. At 72 seconds the system was coming apart and by 74 seconds the Orbiter was destroyed. The first signs of trouble were ambiguous because indications that the Orbiter was adjusting to aerodynamic forces due to the leak in the SRB joint appear very similar to signals generated when the Orbiter responded to upper atmosphere winds. It would be very risky to initiate any kind of crew escape action based on

<sup>122</sup> Cmte Hgs, Transcript, June 25, 1986, pp. 132-35, 139-41. Former astronaut, General Thomas Stafford, testified strongly in favor of crew escape systems but seemed to represent a minority view.



this sort of signal. The Solid Rocket Boosters began coming off the system at 72 seconds, after which an escape system might well have been inoperable due to mechanical deformations of the Orbiter structure under the aerodynamic loads that resulted. Thus, there was a period of time of something less than 9 seconds during which some kind of escape system might have been able to help the crew. It seems clear that attempting to develop a system to respond effectively to a situation such as this would be unproductive and that it would be wiser to improve the safety and reliability of the system during this ascent phase.

After the termination of SRB thrust, immediate crew escape is difficult because the Orbiter has achieved a very high altitude. However, under a range of circumstances it is possible to fly the Orbiter back to a controlled gliding landing at a runway. Under other circumstances, for example if the main engines fail shortly after SRB termination, the Orbiter may be forced to ditch into the ocean and such a ditching is not survivable.

Therefore the Rogers Commission recommended, and the Committee agrees, that NASA should attempt to minimize these risks. That is, NASA should take steps to increase the probability of the Orbiter being able to fly to a landing site and NASA should attempt to develop a way for the crew to escape from controlled gliding flight, for example, if the Orbiter is approaching a ditching or a crash landing.

After SRB termination a principal risk is that the Orbiter could lose one, two or three main engines. Depending on when and how this occurred it might be possible to fly the Orbiter to a landing site. It may be possible and perhaps practical to increase the probability of the Orbiter successfully accomplishing this maneuver through flight design. That is, it might be possible to accept somewhat reduced payloads and achieve more conservative trajectories which would minimize the exposure of the Orbiter to ditching or crash landing if main engine failure were to occur during the ascent phase.

If the Orbiter finds itself in a situation (due to Main Engine failure or other failure) where it cannot fly to a runway but is otherwise under control, the crew might be able to escape during the controlled gliding descent. This would apply not only during the ascent phase but also during the landing phase. For example, if the reentry trajectory were miscalculated and the Orbiter could not reach the planned landing site the crew might have adequate time to bail out. There is a change that such a bailout system could be achievable with acceptable performance penalties. Certainly this last option—crew bail-out during gliding flight—must be very carefully studied.

The trade offs and calculations that have to be made in the area of crew escape and launch abort are activities in which astronaut involvement would be most useful.

Astronauts clearly represent the principal source of flight experience and therefore can make major inputs to decisions regarding what is practical to accomplish during flight. It is pointless to add risks, weight, and cost for a system that cannot be operated by the astronauts during flight conditions. Involvement of astronauts in management is discussed in section VI. B. 2. a. of this report.

In summary, space flight will always be a bold and dangerous venture. NASA must work to better understand the risks of space flight and in particular the risks of each Shuttle launch and to reduce these to an acceptable level.

## B. MANAGEMENT ISSUE

### 1. TECHNICAL MANAGEMENT

#### a. Risk Management Issues

##### *Issue*

There a coordinated and effective risk management program in the NSTS?

##### *Findings*

1. NASA does not explicitly use a centralized program that coordinates all the factors that encompass an adequate risk management program.

2. As a result of the accident, NASA is reexamining the Failure Modes and Effects Analyses (FMEA) and Hazard Analyses (HA) to reassess risks associated with the designs of Shuttle subsystems.

3. NASA's lack of statistical data on the performance of certain components will limit the usefulness of sound engineering judgment in much the same way as it limits the usefulness of probabilistic risk assessment.

##### *Recommendations*

1. NASA should develop and provide to the Committee a description of an overall risk management program as it relates to the Space Shuttle. This effort should include a determination of whether or not a more centralized coordination of a risk management program and issuance of direct risk management guidance directives are needed.

2. NASA should review analytical methods utilized in the performance of risk assessment, including statistical analyses, trend analyses and probabilistic risk assessment methodologies to determine their applicability to the NSTS program. Assistance from the National Academy of Sciences, or other appropriate organizations with expertise in these matters, may be required to adequately perform this review.

3. NASA should review its certification testing to ensure that all critical items are adequately tested. Data obtained from these tests should be used when appropriate in conducting a formal risk assessment.

##### *Discussion*

NASA does not have a specifically labeled risk management program. The process is accomplished by the agency through its configuration management program and the FMEA performed on each component of the Space Shuttle. The identification of critical items is the principal product of these analyses. The ability to make the programmatic or engineering changes necessary to enhance the

safety and performance of flight systems while controlling costs and schedule is the task of the risk management activity.

The process of risk management as applied to systems such as the Shuttle can be described schematically as shown in Figure VI-3,<sup>123</sup> which shows the various steps that might be imposed upon flight systems such as the Shuttle through a risk management program.

---

<sup>123</sup> Douglas B. Feaver, "Success Relaxed NASA's Vigilance", *Washington Post*, May 26, 1986, pp. A-1, A-10.

# RISK MANAGEMENT: DECIDING HOW SAFE IS SAFE?

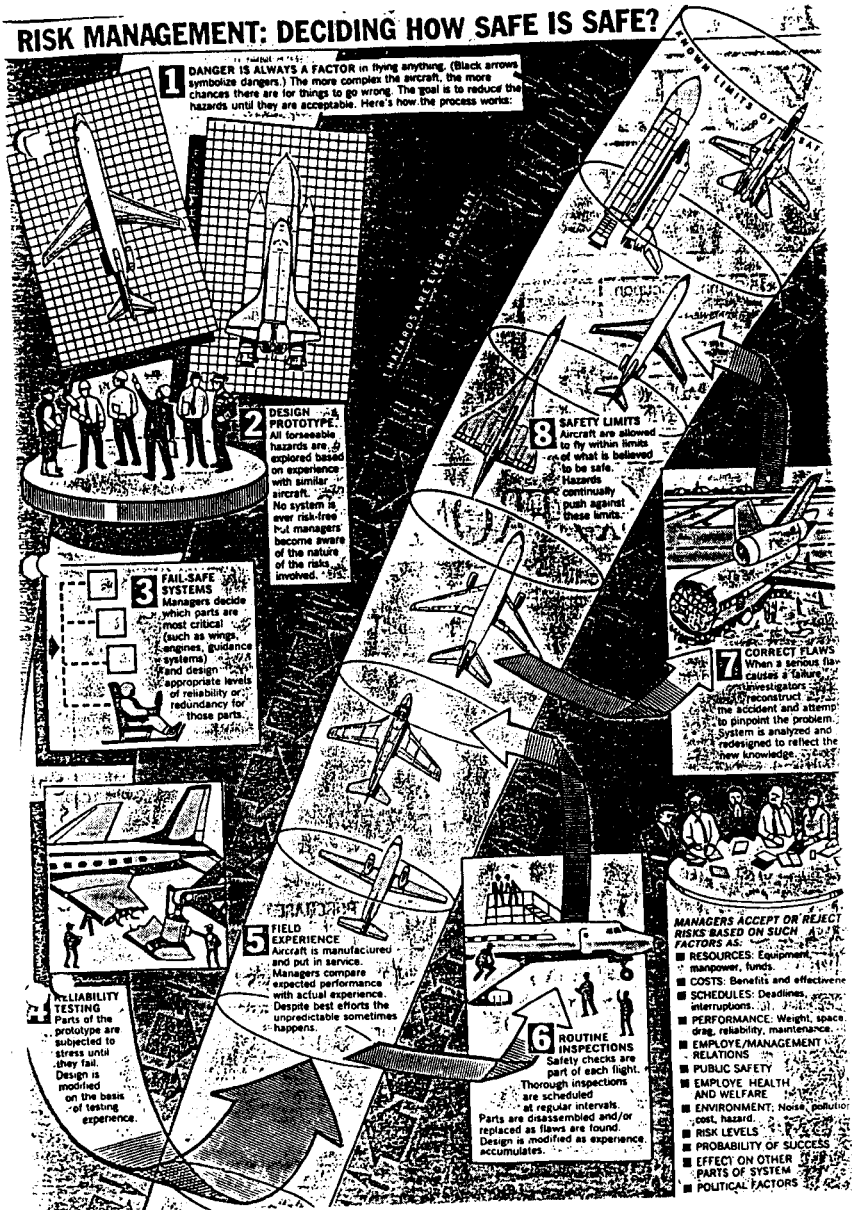

FIGURE VI-3

Top NASA managers lack a clear understanding of risk management. Dr. Fletcher, NASA's Administrator, made the following statement, when asked by Mrs. Lloyd to "describe the elements of NASA's risk management activities . . .":

Well, risk management is a pretty generic term. Risk management is decided in Headquarters in terms of what are the chances of an overall failure of a system under a given set of circumstances. When you get down to the flight team, the launch crew in those last several hours or couple of days, risk management is an entirely different thing. They have to look at the factors that have come up just before launch and assess whether this is a risk we want to take. This is a judgement question; you can't make calculations at this point.<sup>124</sup>

Dr. Silveira, NASA's Chief Engineer, testified on the same day that,

As we had mentioned in the testimony that we gave previously . . ., the only time that we had gone into trying to assess a probability, if you will, or a risk, was as a result of a request that was made by DOE for their analysis that they were performing at that time, to assess the probability of failure of the vehicle, to assess the danger when we are flying the RTG's, the radioactive material.

As far as in our program, and any major decisions that we would make, we have a number of reasons why our past history had indicated that that was not a good way of doing it. As a result, we don't use it generally in our risk management, we prefer using things like the failure effects and analysis that we do; the technical engineering judgement, using things to control our failures rather than depending upon a probability analysis to assess it.<sup>125</sup>

However, Mr. Robert Thompson, who was Shuttle Program Manager from 1970 to 1972, testified on July 24th before the Committee in a much less ambiguous fashion regarding his view on the importance of risk management:

I would first like to make an observation on the decisionmaking process. Evidence, in retrospect, points to a long period of time, especially based on post-flight inspections when the joint design weakness was 'sending a message' and the true potential of this message was not perceived and reacted to.

This, combined with perlaunch discussions between Marshall and Thiokol, points out the need that must pervade the Shuttle management team in the future. A very strong risk management . . . I have parentheses around risk management. I will be happy to expand on that. It has a certain meaning to me. A very strong risk management organization must be kept in place and a continuing search for potential failures must be maintained. . . .

<sup>124</sup> Cmt Hgs, Transcript, June 12, 1986, p. 186.

<sup>125</sup> Ibid. p. 187.

The role of the program manager in this risk management organization must be very strong and clear. The entire program organization from top to bottom must be clearly chartered and as people come and go these organizational relationships must be carefully maintained.<sup>126</sup>

Based upon the divergences of these testimonies, the Committee concluded that although NASA's Space Transportation System program contains the elements of a risk management program, there needs to be a new and heightened coordination of the separate activities by NASA in order to minimize the risks inherent in Shuttle flights.

The FMEAs determine the worst case "What if" scenarios for all possible failure modes and their potential worst case or intended effects.<sup>127</sup> As a result of performing the FMEA, a list of critical items is identified. NASA's FMEA assure that all Criticality 1 and 1R systems are properly identified and classified. The failure of these items would produce loss of life and/or loss of vehicle. The FMEA applies strictly to the hardware associated with the NSTS and is "bottoms-up" analysis, in which a single component failure is traced and its effect on a particular subsystem, subsystem interfaces, and the overall flight systems is determined. Accompanying the FMEA is the Hazard Analyses (HA) which is, according to NASA, a "top-down" approach that takes into account human factors in evaluating the consequences of particular accidents or accident scenarios. Hazard Analysis is the basic tool of the safety evaluation.

The FMEA as used by NASA assigns no probability numbers to event sequences along a given failure path. Although NASA regards the methodology of FMEA as rigorous, within the agency there was a wide variation in the engineering judgments among the design engineers and senior management in the NSTS program on the probability of failure of the Shuttle.<sup>128</sup> The Committee, in hearings held earlier this year related to the safety aspects of the Shuttle Centaur in its utilization of Radioisotope Thermoelectric Generators on board the Shuttle spacecraft, also found wide discrepancies in the estimate of the failure probability for the Solid Rocket Booster among the experts.<sup>129</sup>

NASA has rejected the use of probability on the basis that such techniques are insufficient to assure that adequate safety margins can be applied to protect the lives of the crew. They also argue that their problem correction procedures preclude the establishment of a sufficient statistical database, because once a single point failure has been identified through the FMEA, steps are taken to design

<sup>126</sup> Ibid., July 24, 1986, p. 106.

<sup>127</sup> It is the prime responsibility of the design engineers working with reliability analysts to perform the FMEA in accordance with guidelines established in NASA documents (Appendix VI-C). These documents are provided as part of each statement of work submitted to the contractor. From such FMEAs, a Critical Items List is established in which particular components under the responsibility of the contractor are categorized in accordance with their criticality to the mission, crew, and/or spacecraft. Included as Appendix VI-D is NASA's document 100-2G entitled *Reliability Desk Instruction, Flight Hardware Failure Mode and Effects Analyses (FMEA) and Critical Items List (CIL)*.

<sup>128</sup> Rogers Commission Report, Volume II, p. F-4.

<sup>129</sup> Hearing before Subcommittee on Energy Research and Production and Subcommittee on Space Science and Applications of the Committee on Science and Technology, 99th Cong., 2nd Sess., March 4, 1986 (No. 97). "Review of RTG Utilization in Space Missions."

the safety features into the component, thereby eliminating the failure mode or establishing sufficient redundancy to preclude catastrophic failures associated with the particular component. This change of the component means that earlier data no longer apply.

On the other hand, with respect to certification testing of the Space Shuttle Main Engine, NASA seems to argue that a useful statistical data base can be generated even though the configuration of the engine is changed as data is accumulated. That is, as running time is accumulated in SSME certification testing, major components—e.g., the high pressure turbopumps—are replaced, and yet NASA seems to believe that the total accumulated running time has some meaning for determining engine life time.<sup>130</sup>

All subsystems of the NSTS are intended to meet design requirements that incorporate the fail-safe features as a minimum with fail-operational/fail-safe criteria placed on all Orbiter avionics systems.<sup>131</sup> Fail-safe requirements are defined as designs which can withstand a single failure and permit return of the crew to the ground safely. Fail-operational/fail-safe is defined as permitting two sequential failures while enabling crew return. There are some parts of the NSTS which must be exempted from meeting these criteria. The reason is that it is not possible to improve the safety features of these systems through redundancy or other means. Such systems are the primary structure, the thermal protection system, pressure vessels and the premature firing mode of the pyrotechnics. For example, the pressure vessel cannot be provided with redundancy in a safe manner because addition of another pressure vessel would only enhance the failure probability or the criticality of this component.

The FMEA is a very conservative analysis according to NASA since it provides information on worst case situations of all possible failure modes and the potential worst case effects. Even so, the Committee was unable to determine the degree to which flight anomalies and trend analyses in historical performance data are utilized to insure that the appropriate measures are taken in the design and testing of various critical components to assure ultimate safety and minimization of risk.

NASA is presently reviewing the 748 Criticality 1 items and the 1,621 Criticality 1R items. Based upon a series of tests and analyses and the availability of methods and instrumentation to detect problems associated with various Criticality 1 and 1R items, waivers are given to permit flight of critical items. Before a waiver is granted, according to NASA, extensive documentation and review of each item on the Critical Items List (CIL) for which a waiver has been applied must be undertaken and approved all the way through Level 1 management. There is a difference between the number of waivers granted and the total number of items on the Critical Items List. For Criticality-1 items this difference reflects the number of systems exempted from the criteria of fail-safe or fail-operational/fail-safe. NASA, however, does not distinguish in its quality control procedure between exempted items and those items which are not exempt from the waiver process. According to

---

<sup>130</sup> Rogers Commission Report, Volume II, pp. K25-26.

<sup>131</sup> NASA Briefing on July 10, 1986.

NASA, this categorization of exempt versus waiver is strictly a management technique for identifying components and systems on the Space Shuttle in terms of their safety compatibility.

The Committee finds the FMEA to be an appropriate method for identifying the Critical 1 and 1R elements of the NSTS; however, not all the elements so identified pose an equal threat. Without some means of estimating the probability of failure of the various elements it is not clear how NASA can focus its attention and resources as effectively as possible on the most critical systems. Moreover, waivers can be granted without assurance that an adequate level of safety has been achieved.

#### b. Launch Decision Process

##### *Issue 1*

Is the process for establishing launch constraints and dealing with them effective?

##### *Findings*

1. There is no clear understanding or agreement among the various levels of NASA management as to what constitutes a launch constraint or the process for imposing and waiving constraints.

2. Launch constraints were often waived after developing a rationale for accepting the problem rather than correcting the problem; moreover, this rationale was not always based on sound engineering or scientific principles.

##### *Recommendations*

1. NASA should establish rigorous procedures for identifying and documenting launch constraints. The individual(s) responsible for implementing this procedure should be clearly identified, and well defined and understood criteria for waiving the constraints should be established.

2. NASA should exercise extreme caution in waiving launch constraints before correcting the problem that led to the launch constraint. The rationale should be based on rigorous scientific/engineering analyses or tests and should be understood and accepted by the Program Manager.

##### *Discussion*

No single system exists for establishing and dealing with launch constraints within the Shuttle Program; for example, Marshall maintains their own system through their Problem Assessment Center (PAC) to deal with problems affecting the propulsion system. In testimony before the Rogers Commission, Mr. Mulloy explained that the system was established to provide visibility for problems relating to the propulsion system and a "launch constraint" was in effect a flag to alert the Project Office to address the problem at the Flight Readiness Review.

A launch constraint means that we have to address the observations, see if we have seen anything on the previous



flight that changes our previous rationale, and address that at the Flight Readiness Review.<sup>132</sup>

The NSTS Program Manager stated that he was unaware that a launch constraint had been imposed as a result of the O-ring erosion. Unawareness of this launch constraint was also claimed by the Level I Program Office and key Thiokol personnel: Msrs. Ebeling, Kilminster, Russell, McDonald, and Boisjoly.<sup>133</sup>

In staff briefings, it was suggested by NASA personnel that perhaps "launch constraint" was a poor choice of words to describe this process for flagging problems. Those individuals who claimed no knowledge of a launch constraint had certainly been made aware of the O-ring erosion problem. This problem and the resolution had been discussed throughout the system including the FRRs. Therefore, although it is difficult to understand why the Program Manager and others weren't more familiar with the Marshall PAS, as a practical matter it probably had little effect on the final decisions. These "launch constraints" were potential problems that had to be resolved prior to flight and the Level III Project Managers were responsible for resolving any problems dealing with their systems. During the Rogers Commission hearings, Mr. Mulloy acknowledged that he had ultimate responsibility for waiving the launch constraints and ultimate responsibility for the launch readiness of the Solid Rocket Boosters.

Although the O-ring erosion continued to occur, and with no apparent pattern, the SRB Project Manager repeatedly waived the launch constraint. Throughout the Rogers Commission hearings and the hearings of the Committee on Science and Technology, NASA witnesses continually justified their decision to continue flying the Shuttle based on their previous successful flights. This reliance on their "experience base" was a major factor in the repeated waivers of the Marshall imposed launch constraint on the SRBs. Chairman Rogers asked Mr. Mulloy what was meant by "addressing" the problem, and Mr. Mulloy responded:

I mean present the data as to whether or not what we have seen in our most recent observation, which may not be the last flight, it may be the flight before that, is within our experience base and whether or not the previous analyses and tests that previously concluded that was an acceptable situation is still valid, based upon later observations.<sup>134</sup>

Mr. Mulloy also explained his reliance on the experience base in testimony before the Science and Technology Committee:

That was presented to me as a rationale to continue flying, one we had seen it on STS-2, what we saw on the last flight wasn't as bad, therefore it was an acceptable risk.<sup>135</sup>

<sup>132</sup> Rogers Commission Report, Volume V, p. 1513.

<sup>133</sup> *Ibid.*, p. 1590; note: Yet it was Mr. McDonald who wrote a letter to the SRB Project Office recommending that the O-ring problem be dropped from the Problem Assessment System (PAS), which was in fact equivalent to removing the launch constraint.

<sup>134</sup> Rogers Commission Report, Volume V, p. 1513.

<sup>135</sup> Cmte Hgs, Transcript, June 17, 1986, p. 151.

The Committee concurs with Dr. Feynman's analysis that NASA had no understanding of the O-ring erosion phenomenon, and their rationale for accepting it was not based on sound engineering principles.

. . . The acceptance and success of these flights is taken as evidence of safety. But erosion and blow-by are not what the design expected. They are warnings that something is wrong. . . . The fact that this danger did not lead to a catastrophe before is no guarantee that it will not the next time, unless it is completely understood. . . . The origin and consequences of the erosion and blow-by were not understood . . . officials behaved as if they understood it, giving apparently logical arguments to each other often depending on the "success" of previous flights.<sup>136</sup>

### *Issue 2*

Are the launch commit criteria procedures adequate to ensure the safety of the mission?

### *Findings*

1. The procedure used for developing launch commit criteria is systematic and thorough; however, violations of the criteria do not necessarily mean "no go". Therefore, NASA sometimes relied on engineering judgments made during the terminal countdown in determining whether to launch.

2. Launch commit criteria were sometimes waived without adequate engineering analysis or understanding of the technical reasons for establishing the criteria.

### *Recommendations*

1. NASA should review the launch commit criteria procedures, especially those for dealing with violations, to lessen the reliance on engineering judgments under stress.

2. When situations arise where "real time" engineering judgments are unavoidable, NASA should adopt a more conservative approach to waiving previously established criteria. In no case should a criterion be waived without a thorough understanding of the rationale for the establishment of the criterion.

### *Discussion*

Launch commit criteria define limits on specific system parameters which are required to be monitored during the terminal countdown. When these limits are exceeded the launch is held until the condition is corrected or an acceptable alternate capability or procedure is instituted.

Proposed criteria are developed by NASA and contractor personnel and are submitted to the NSTS Program Office for review and disposition. All changes are controlled by the Level II PRCB (Program Requirements Change Board) and all launch commit criteria are reviewed prior to each flight at the launch site flow review (8 weeks prior to launch), the Flight Readiness Review and the L-1

<sup>136</sup> Rogers Commission Report, Volume II, p. F-1.

review. Where practical Launch Commit Criteria include pre-planned decisions on courses of action to be taken when violations occur.

The process described for developing and controlling the launch commit criteria is systematic and thorough; however, in briefings by NASA personnel it was learned that it is not uncommon to experience violations of the specified limits. These can often be resolved in a straight forward manner based on a prior plan of action; however, the Committee is concerned that in those situations where no preplanned course of action is available, real time engineering decisions are being made under the stress that is inherent in a pre-launch environment. This is particularly undesirable when it is perceived that there are pressures to launch.

For example, it was learned that on the morning of the scheduled launch of STS 51-L the Mission Evaluation Room (MER) Manager requested a waiver of the Launch Commit Criteria lower limit of 31 degrees F.<sup>137</sup> The Flight Director can not unilaterally waive launch commit criteria and since the temperature at launch was above 31 degrees it became unnecessary to pursue the matter further. Had it been necessary to waive the criterion, the Flight Director would have advised the Program Manager who then would have orally polled the Project Managers before making the final decision. One can only conjecture at this point what the decision would have been; however, the Committee is concerned that at least two key managers in the decision making chain (i.e. the MER Manager and the Flight Director) were prepared to waive the criterion without thoroughly understanding it.

### *Issue 3*

Are the launch readiness review procedures and communications adequate?

### *Finding*

The Committee finds that the review procedures and communications used to assure flight readiness were systematic, thorough, and comprehensive and provided ample opportunity for surfacing hardware problems prior to flight. Level I FRRs are usually recorded (audio); however, there is often no record made of other key pre-launch meetings.

### *Recommendation*

NASA should make every reasonable effort to record meetings where key decisions might be made; in particular, all formal Flight Readiness Reviews, including the L-1 and the Mission Management Team meeting should be recorded, where feasible by video.

### *Discussion*

The Flight Readiness Review process encompasses a series of reviews beginning with contractor reviews of their systems, and going through the Project Management review (Level III), and NSTS Program Management review (the "Pre-FRR"), and culmi-

<sup>137</sup> Rogers Commission Report, Volume II, pp. J22-23.

nating in the Level I (Headquarters) review which is referred to as "the" FRR. One additional formal review takes place 24 hours before launch and is called the "L-1" review. This is conducted by the Mission Management Team (MMT) which is appointed by the Associate Administrator for Space Flight at the time he calls for the FRR. All open work and action items identified at the FRR are closed out at the L-1. In addition to conducting the L-1 review, the MMT functions as a technical advisory body for the Program Manager and is on call beginning 48 hours before the launch until after the mission is completed and the Orbiter is safed.

The Committee concurs with the Rogers Commission that NASA should record key pre-launch meetings; however, the Committee finds no basis for concluding that the Flight Readiness Review procedure is flawed; on the contrary, the procedure appears to be exceptionally thorough and the scope of the issues that are addressed at the FRRs is sufficient to surface any problems that the contractors or NASA management deem appropriate to surface. However, the Flight Readiness Reviews are not intended to replace engineering analysis, and therefore, they cannot be expected to prevent a flight because of a design flaw that management had already determined represented an acceptable risk. In addition all the appropriate offices, including the Chief Engineer representing SR&QA, are represented at the FRRs. Specifically, from the first evidence of O-ring erosion to the final decision to launch 51-L, the process provided ample opportunity to review and assess the severity of the problems; moreover, all levels of NASA management were made aware of the erosion.<sup>138</sup> However, a process is only as effective as the responsible individuals make it. For example, see section VI B.2.c. on the weakness in the SR&QA organization.

#### *Issue 4*

Was the failure to inform the Level I or Level II Program Managers of the Teleconference involving NASA and Morton Thiokol on the eve of the launch a factor in the decision to launch?

#### *Findings*

1. The Committee finds that Marshall management used poor judgment in not informing the NSTS Program Manager or the Level I Manager of the events that took place the night before the launch, specifically the stated concerns of the Thiokol engineers. However, the Committee finds no evidence to support a suggestion that the outcome would have been any different had they been told.

2. The Committee finds the efforts of Thiokol engineers to postpone the launch commendable; however, Thiokol had numerous opportunities throughout the normal flight readiness process following flight 51-C in January, 1985 to have the new minimum temperature criteria established.

---

<sup>138</sup> Ibid., pp. H1-97.

### *Discussion*

The management of the Shuttle Program has given the responsibility for the Solid Rocket Boosters to the Marshall Space Flight Center. It is the Marshall Center that contracts with Thiokol for the hardware and related services pertaining to the SRBs. The NSTS Program Manager relies on the Marshall management and technical expertise for issues relating to the SRB and it is unreasonable to expect him to take technical advice from the contractor's engineers. This position is supported by the actions taken by Mr. Aldrich and Mr. Moore with regard to the Rockwell concerns over ice.<sup>139</sup> Unlike the SRB situation where the Thiokol managers gave a written positive recommendation for launch, the Rockwell managers refused to give an unqualified go for launch; yet Mr. Aldrich asked for and accepted the recommendations of the Orbiter Project Manager and the Directors of Engineering at JSC and KSC. The Committee finds no evidence to suggest that in the instance of the Thiokol engineers' concerns, either Mr. Aldrich or Mr. Moore would have disregarded the recommendation of the technical managers with the expertise in solid rockets (i.e. Marshall and Thiokol) and relied instead on their own assessment of the engineers' concerns.

Launch commit criteria and launch constraints should be established well in advance of a scheduled mission and should be based on rational, scientific and engineering arguments, including previous flight experience. Thiokol engineers based their arguments for a 53 degree temperature criteria on the fact that this was the coldest temperature experienced to date and they had experienced severe (but not necessarily the worst) erosion on that flight. However, a test firing had been conducted at 40 degrees joint temperature which resulted in no joint problems (technicians had "tamped" the joint putty before the test, however, a procedure not used on flight hardware). Moreover, it was pointed out in the hearing that this flight had occurred a year earlier and no mention had been made of changing the temperature criteria for launch.

Mr. VOLKMER. But in all of the memorandums, et cetera, that had occurred before—in-between the time, January 1985 and January 1986, you don't specifically say that. . . .

Mr. BOISJOLY. That is right, . . . It was nobody's expectation we would ever experience any cold weather to that degree before we had a chance to fix it again, so that basically is why it wasn't pursued any further than that from my personal standpoint.<sup>140</sup>

That was later questioned by Mr. Nelson in remembering that flight 61-C (the flight just prior to 51-L) had been scrubbed four times for reasons unrelated to temperature when the temperatures were less than 53 degrees during several of those scrubs, reaching down into the low 40s during the first scheduled launch.

<sup>139</sup> *Ibid.*, Volume I, pp. 114-17.

<sup>140</sup> Cmte Hgs, Transcript, June 18, 1986, pp. 83-84.

Mr. NELSON. . . . and so my question is, did any of these same concerns with the temperature come up in discussions during the final checks before those attempted launches?

Mr. McDONALD. I am not aware that they had, Congressman. I don't know. I wasn't at that launch, but I don't recall that that came up.<sup>141</sup>

Mr. Nelson later asked the Commander of 61-C, Cdr. Robert L. Gibson, whether he recalled any discussion among management or any of the contractors regarding the desirability of launching in 41 degree weather; Commander Gibson also recalled no special concerns regarding temperature.<sup>142</sup>

Mr. Packard also questioned Mr. McDonald about the temperature during earlier attempts to launch 51-L and asked whether in fact it had been below 53 degrees during some of those attempts. Mr. McDonald replied, "That is correct", and when asked whether temperature had been discussed at those times, Mr. McDonald said, "No, it was not . . . Nowhere was it, no." Mr. Packard also asked why, in Mr. McDonald's judgment, temperature had not been discussed in as much as the temperature was below what they believed to be safe, and Mr. McDonald answered, "I don't—I can't answer that."<sup>143</sup>

Mr. Packard also noted the delay in evaluating the effects of temperature, quoting from Mr. Kilminster's testimony, "As launch was scheduled for early the next day, our engineers immediately commenced evaluating the available data." He asked why they waited until the night before the launch to begin even considering the whole question of O-ring resiliency and O-ring problems under cold weather conditions. Mr. Kilminster replied that this was in response to a specific request by NASA.<sup>144</sup>

This indicated that the concerns and recommendations of the Thiokol engineers were solicited by NASA, and in as much as they had not come forth with the recommendation for a higher minimum temperature criterion on earlier occasions when it was planned to launch at temperatures below 53 degrees, it is unlikely that this recommendation would have been made on this occasion without the specific inquiry by NASA.

The Committee finds no evidence that new data were presented during the January 27th teleconference that were not available to Thiokol at the time of the Flight Readiness Review. Moreover, the information presented was substantially the same as that presented at the August 19th briefing (see Section VIII) at which time they had recommended that it was safe to fly as long as the joints were leaked checked to 200 psi, were free from contamination in the seal area and met O-ring squeeze requirements. No mention was made of a temperature constraint at that time or anytime between then and the January 27th teleconference.

The Committee finds that Thiokol's advice and recommendations to NASA were inconsistent, and therefore, the arguments present-

<sup>141</sup> Ibid., p. 98.

<sup>142</sup> Ibid., June 25, 1986, p. 78.

<sup>143</sup> Ibid., June 18, 1986, p. 100.

<sup>144</sup> Ibid., p. 101.

ed during the January 27th teleconference might not have been as persuasive at the time as they now appear to be in hindsight.

*Issue 5*

Do the principal contractors have an appropriate role in the launch decision making process?

*Finding*

The principal contractors have an active role throughout the decision making process right up to the launch; however, the look of a firm requirement for their concurrence at the time of launch does partially relieve them of responsibility for mission success.

*Recommendation*

Principal contractors should be required to make a clear, unambiguous statement concerning launch readiness just prior to launch.

*Discussion*

Participating contractors are required to sign off prior to launch that their flight system or facility is ready to support the flight. This is generally a one-time requirement for a given mission and although they are orally polled prior to the flight, they are not generally required to make any additional written positive commitment for a "go" prior to launch. Mr. Richard Davis, President, Martin Marietta Michoud Aerospace, explained:

Up to and including the L-minus-one-day review, there's no doubt that every company has a very strong voice; and, as a matter of fact, at the L-minus-one-day review, they are required to stand up and commit their hardware as go or no-go. And those are very unequivocal commitments, also. After that time, then the reviews are more mission management meetings that are held, and as you get down into the countdown, it turns into more of a real time polling of the people that are actually controlling the launch.

In those latter meetings we are not, I would say, formally involved in those unless there is some problem with the hardware itself . . . We are polled by the Director of Engineering prior to the launch actually proceeding, so we are sort of polled in an informal manner. We are not asked at any time after the L-minus-one-day for a formal go or no-go.<sup>145</sup>

Contractors can stop the launch if they have serious reservations about the safety of the mission, and presumably they would.

Mr. DAVIS. . . . I have never felt that if I needed to stop a launch, I could not stop it. While I have not been asked for a positive go or no-go, the ability is always there if I decide no, to stop the launch.<sup>146</sup>

<sup>145</sup> Ibid., July 15, 1986, pp. 71-72.

<sup>146</sup> Ibid., p. 73.

However, the present system permits them to “express concern” without actually saying, “stop the flight, it is unsafe”. If the odds favor a successful flight they do not have to be responsible for cancelling, yet if the mission fails they are on record as having warned about potential dangers. (see Section V, discussion over Rockwell concerns over ice)

*Issue 6*

Are astronauts adequately represented in the decision making process?

*Finding*

The astronauts believe they currently have the opportunity to make inputs into the process and are reluctant to assume a greater responsibility for the decision to launch.

*Discussion*

Considerable discussion at the hearing focused on the astronaut’s interest in being more involved in the decision making, for example by attending management meetings. Capt. Young made the point that astronauts really didn’t have the time to attend a lot of meetings, or the technical expertise to influence the decision.

We could certainly put people in those kinds of meetings. I am not sure they have the technical expertise to really be able to say go or not go.<sup>147</sup>

With regard to the SRB seals, he pointed out that he and Captain Crippen had attended a briefing at Thiokol where it was stated that the seals weren’t even necessary, and some people were complaining about having to put two seals in. And he suggested that if others in the agency had understood the problem they would have stopped the flights.

The rest of the agency, if they had been aware of this problem, we wouldn’t have flown. We would have fixed it. If other people responsible in the management structure had the feeling this was a serious problem, we wouldn’t have gone. We have to believe that, because there, on the Orbiter, there are 1500 criticality 1 items on the Orbiter alone, on STS-1, those items are still there, and if the management system can’t make sure those things are ready to fly, we can never fly again.

If you have an astronaut saying every step of the way, don’t fly because of this, that or this, where they have no expertise, it would be troublesome.<sup>148</sup>

Mr. Lujan asked whether NASA should consider a new class of astronauts with specific technical expertise who would fly occasionally. Capt. Young suggested that this was not a good use of an astronaut’s talents.

You can get real good engineers to do the same thing, a heck of a lot cheaper, and make just as good inputs. . . .

<sup>147</sup> Ibid., June 25, 1986, p. 42.

<sup>148</sup> Ibid., p. 44.



In the main, you like to keep astronauts around to fly spaceships because that is their talent, and that is what they want to do. . . .<sup>149</sup>

General McDivitt concurred:

There should be a caution about putting too much responsibility on astronauts, when they don't have the time to do it. Like the flight crew commander is very busy prior to flight and does not have time to spend a lot of his time involved in reviewing engineering decisions that have already been made by very professional people. . . .<sup>150</sup>

In response to suggestions that the astronauts might have stopped the launch of 51-L had they been aware of the problems with the seals, Capt. Young provided an excellent analogy to illustrate his skepticism that they would have altered the decision to launch:

If an engine man comes up and says that engine is ready to fly and the turbine blades are a little cracked but we have run tests and we can show with a cracked turbine blade the engine pumps are not going to come apart and we have got to fly, would an astronaut say no, you are not going to fly until you change the turbines, for example?<sup>151</sup>

There was complete agreement among the astronauts who testified that the crew should be able to make inputs to the decision making process, but they all felt they now have this opportunity; they can and do attend FRRs and other meetings. However, there was a strong feeling among the astronauts that they had to rely on the expertise of the engineers and the technical competence of the managers and could not be expected to intervene in that process. They believed it was unrealistic to expect the crew to make the go or no-go decision; astronauts should not be expected to represent the principal concern for safety.

Major Slayton made the point that astronauts in general were willing to take more risk than management, not less.

One philosophical point that needs to be brought out here . . . is that the crew commanders and astronauts in general view things a little bit different than everybody else does to begin with and you have to recognize that and be a little bit cautious.

In general a crew commander, if given a choice, is willing to take more risk than his management. That has been the case in the past and he is more likely to give you a 'go' and you need somebody at a higher level that is willing to, on his behalf, saying to take the bull by the horns and have the guts to say 'no go' on behalf of the crew.<sup>152</sup>

Col. Hartsfield concurred:

<sup>149</sup> Ibid., p. 49.

<sup>150</sup> Ibid., p. 53.

<sup>151</sup> Ibid., p. 64.

<sup>152</sup> Ibid., p. 54-55.

I wanted to say that I feel that it is just like in our own government, the buck stops at the White House or the Congress perhaps, but somewhere, but certainly above the level of the rest of us.

I think that the decision to go or "no go" rightfully belongs with the upper management, and not, my personal opinion, not with the crew. The crew input should be felt very strong.<sup>153</sup>

### c. Technical Expertise of Personnel

#### *Issue*

Does NASA have an adequate level of in-house technical expertise to manage the Shuttle Program properly?

#### *Findings*

1. During the last decade NASA has had significant decreases in manpower. A disproportionate reduction may have occurred in the safety, reliability and quality assurance staff at NASA headquarters and at the Marshall Space Flight Center. Additionally during the period preceding the Challenger accident, the Office of Space Flight also suffered a decline in staff. The decreases may have limited the ability of those offices to perform their review functions.

2. The information presented to NASA headquarters on August 19, 1985 was sufficient to require immediate and concentrated efforts to remedy the joint design flaws. The fact that NASA did not take stronger action to solve this problem indicates that its top technical staff did not fully accept or understand the seriousness of the joint problem.

#### *Recommendations*

1. NASA should review the numbers and qualifications of key staff in technical and management positions and should consider additional training and recruitment of individuals to further the quality and safety of NASA's missions.

2. The Committee should maintain on-going oversight of this analysis and conduct an in-depth examination upon the conclusion of NASA's review.

#### *Discussion*

In the wake of the Challenger accident, serious questions arose over whether NASA had sufficient technical capability to identify and solve problems like the SRB seal problem. It is argued that through reductions in staffing levels and departures to the private sector by experienced technical employees, NASA lacked in-house problem assessment capability. This is an issue that is not subject to ready answers, and an in-depth examination of NASA technical capacity was generally beyond the scope of the Committee's hearing.

However, it is clear that over the last 15 years NASA has had significant staffing reductions and that a disproportionate number of these reductions may have occurred in the areas of quality assurance and safety.<sup>154</sup> While NASA argues that its personnel levels for these functions "were adequate,"<sup>155</sup> the Rogers Commission found:

<sup>153</sup> *Ibid.*, p. 55.

<sup>154</sup> *Ibid.*, June 11, 1986, pp. 59-70.

<sup>155</sup> *Ibid.*, p. 60; material supplied for the record.

Reductions in safety, reliability and quality assurance work force at Marshall and NASA Headquarters have seriously limited capability in those vital functions.<sup>156</sup>

Reductions were not limited to the safety and quality assurance program. The former Associate Administrator for Space Flight, Jesse Moore, testified that his office also experienced a decline in the number of staff. As Mr. Moore observed, "we need to . . . get as much technical expertise into the Office of Space Flight as we possibly can" in order to "work on a plane with the real experts—the contractors, the engineers, the safety people at the contractors and at the NASA centers. . ."<sup>157</sup>

Similar views were voiced by former Shuttle program manager Robert Thompson:

I think we have to look pretty deep in our organization to make sure we are keeping enough technical muscle in the organization to continually search for these pending problems that are sometimes pretty subtle. Sometimes they just don't, as I say, announce themselves. So you have to be willing to expend the resources and keep that technical muscle in place and you have to put that technical muscle close to the heart of the issue so that they can perceive a problem if it is just beginning to occur.<sup>158</sup>

It does not necessarily follow however, that reductions in the numbers of technical personnel automatically limit the ability of headquarters to identify and correct emerging problems. The adverse impact flows from those reductions that cut into crucial areas. Accordingly, the Committee is pleased that Admiral Truly has undertaken an examination "throughout the agency and particularly in . . . the Space Shuttle program" to make sure that "we have not only the right numbers but the right kind of trained people . . ."<sup>159</sup> It is hoped that this analysis will identify appropriate technical staffing levels and positions that must be maintained if the agency is to properly perform its function.

NASA technical expertise is further reduced by the departure of highly skilled employees. During fiscal year 1985, approximately 1500 employees left the agency, over one-half of these (784) were engineers, technicians and scientists.<sup>160</sup> If present trends continue,

<sup>156</sup> Rogers Commission Report, Volume I, p. 161.

<sup>157</sup> Cmte Hgs, Transcript, July 24, 1986, pp. 80-81.

<sup>158</sup> Ibid., pp. 117-18.

<sup>159</sup> Ibid., June 11, 1986, pp. 61-2. Former Shuttle Program Manager, Robert Thompson, indicated the need for this analysis, stating: ". . . and I think the matter of being sure you have the proper people selected and that those people are properly indoctrinated and trained for their position and they clearly understand the responsibility and reporting channels of their positions, I think those are all areas for improvement."—Cmte Hgs, Transcript, July 24, 1986, p. 121.

<sup>160</sup> Material submitted for the record in response to written questions from Chairman Roe (letter dated 9/18/86). That submission includes the following table:

NASA LOSSES FISCAL YEAR 1981-86

[In fiscal years]

	1981	1982	1983	1984	1985	1986
Total .....	1,983	1,556	1,176	1,530	1,494	1,169
Non-AST* Engineers .....	32	26	13	19	9	5
AST engineers .....	665	503	386	576	569	457
Life scientists .....	6	6	0	3	2	4
Technicians .....	261	207	161	156	204	180

\*Non-Aerospace Technologist.

NASA can expect to lose between 7500 and 9000 technical and scientific employees over the next ten years.<sup>161</sup> While 50 percent of these personnel losses are formally attributed to retirement, NASA officials "know. . . that many retirees leave NASA for higher paying jobs in industry."<sup>162</sup> Additionally, 17 percent of the departing employees acknowledge that they are leaving NASA for more financially rewarding jobs.<sup>163</sup>

NASA is concerned that the difficulty it will experience in replacing these employees is essentially the same that led to the departures; the agency's "salary structure is not sufficiently flexible and competitive to attract the very best talent our nation has to offer."<sup>164</sup> Therefore, despite liberal hire authority for engineering positions, NASA is experiencing difficulty in recruiting entry-level engineers, largely due to salary. As noted by the Agency:

Currently the Government pays GS-7 recent college graduates in all engineering disciplines a special salary rate of \$23,170. This is the statutory maximum under the current special salary rate provisions. At the same time, our private sector competitors are offering these graduates an average salary of \$27,000 to \$29,000 depending on the engineering discipline. It would take approximately a 20 percent increase for us to match our competitors. However, absent a legislative change, the most we could offer in the next year would be the percentage increase to the General Schedule (perhaps two or three percent in January 1987).

A continuing infusion of recent college graduates is critical to the continued success of NASA's mission and accomplishing this has become increasingly difficult. Inadequate salaries are an equally significant problem at the executive levels in the agency.<sup>165</sup>

While outside witnesses did not fully concur as to the prevalence of departures for the private sector, all acknowledged the need to create incentives for quality people to enter and remain with the agency.<sup>166</sup> To this end, NASA Administrator Fletcher is examining means by which his organization can retain its highly skilled technical employees through a "more motivational type of organizational structure" and premium pay scheduled.<sup>167</sup> The Committee shares NASA's concern that it maintain a strong in-house technical capability and support staff.

In addition to the number of technical managers, it is also necessary to examine their technical performance. Insight into NASA

---

<sup>161</sup> Ibid.

<sup>162</sup> Ibid.

<sup>163</sup> Ibid.

<sup>164</sup> Ibid.

<sup>165</sup> Ibid.

<sup>166</sup> Cmte Hgs, Transcript, July 24, 1986, pp. 119-23.

<sup>167</sup> Ibid., pp. 123, 125.

headquarters' technical ability to discern and react to emerging problems may be gained from an examination of the manner in which it addressed the growing concerns with the O-rings in the summer of 1985. Prior to that time the problems with the O-rings had been briefed at all levels of the agency and had been presented to headquarters on at least two occasions.<sup>168</sup> However, increasing problems with case-to-case erosion prompted headquarters to request a complete briefing "to go over the situation in detail."<sup>169</sup>

The meeting was chaired by Mr. Moore's deputy for technical matters, L. Michael Weeks, and attended by a number of other headquarters personnel which Mr. Moore characterized as having "some knowledge about the SRB."<sup>170</sup> In testimony before the Rogers Commission, Mr. Moore described the composition of the meeting:

Mr. Winterhalter, who was Shuttle Propulsion Division Acting Director at that time, Mr. Bill Hamby was the STS program integration Deputy Director, Mr. Paul Wetzel, who was the Solid Rocket Booster programs chief, Mr. Paul Herr, who was the Solid Rocket Motor program manager, and Mr. Henry Quong, who was the reliability, maintainability and quality assurance director of the chief engineer's office.

Those were the group of people at NASA headquarters who attended the meeting. Mr. Mulloy of Marshall Space Flight Center, who was a Solid Rocket Booster program manager, attended and Mr. Bob Swinghammer of Marshall also attended, who is the material and processes laboratory director at Marshall. Thiokol had a total of six people

<sup>168</sup> See, e.g., testimony of L. Michael Weeks, Cmte Hgs, Transcript, June 12, 1986, p. 130; Rogers Commission Report, Volume I, pp. 120-140.

<sup>169</sup> Rogers Commission Report, Volume V, p. 1051, testimony of Jesse Moore. A somewhat different version of the genesis of the August 19 briefing was presented by Allen McDonald, Thiokol's Director of Solid Rocket Motor Project, in testimony before the Rogers Commission (Ibid., pp. 1591-92).

Mr. McDONALD. The meeting that occurred on August 19 came about as a result of this problem with the nozzle eroding through, and that is what drove that meeting. Headquarters wanted to hear about that. We lost the primary seal and eroded some secondary.

We all sat down together and got together with the engineering people and put together that presentation and collectively said, you know, we ought to address the whole seal issue, not just that failure, because we all felt that if that ever happened in the field joint we were in bad trouble because the nozzle has a much better secondary seal than the field joint does.

Mr. SUTTER. At this meeting on August 19th at headquarters, that was called because of Thiokol's concern that the joint was really in trouble?

Mr. McDONALD. No, it was called—we had had another meeting scheduled at Washington headquarters at that time that had a problem with the mixer fire earlier in the year, and there was a review of that.

I believe Mike Weeks either called Joe or I or one of us and said well, you're here, you ought to come and address a couple of other issues that have happened recently that we are very interested in.

One of them is we had broken the structural test article on the filament would case I believe in July down at Marshall, and they wanted to hear about that.

The other one was they were made aware that we had violated the primary seal in the nozzle and wanted to hear about that and what our rationale was to continue.

See also, Cmte Hgs, Transcript, June 17, 1986, pp. 98-101.

<sup>170</sup> Cmte Hgs, Transcript, July 24, 1986, p. 97.

there, including Mr. Mason, Mr. Wiggins, Mr. Kilminster, Mr. McDonald and Mr. Speas.<sup>171</sup>

The briefing documents prepared by Thiokol included a detailed history of seal erosion which noted, *inter alia*, that the "frequency of O-ring damage has increased since incorporation of Randolph putty; higher stabilization pressures in leak test procedures; and high performance motors." The briefing documents also listed MTT's primary concerns; the highest concern was "Field joint—joint deflection and secondary O-ring resiliency."

It is suggested that the August 19th briefing failed to give a complete picture of the seriousness of the O-ring problem because it did not include data on the effect that temperature would have on resiliency of the seals. As Michael Weeks noted in his testimony before the Committee:

When the briefing was presented to us on August 19th of 1985—as you will look in the briefing that was provided to the Commission on February 10th—there was no temperature data presented that showed that the resiliency was such a critical factor. It wasn't until after the disaster of 51-L that I actually saw the resiliency data that showed that Viton, which is the O-ring material that we've been using, is so slow to recover at very low temperatures—<sup>172</sup>

Mr. Weeks correctly notes that the briefing documents did not include data which resulted from bench testing which concluded that resiliency is a function of temperature.<sup>173</sup>

Other participants in the meeting felt that the temperature issue had been presented at the briefing.

General KUTYNA. Secondly, there has been some question that people understood that there was a temperature problem. I remember your conclusions chart, your file chart, and the very first bullet of that chart had the word "resiliency" in it.

Do you feel when you talked about resiliency at that meeting people got the connection between resiliency and temperature, that resiliency was a function of temperature, or was that lost?

Mr. McDONALD. It may have gotten lost because we hadn't run a very long range of temperatures when we got that data.

General KUTYNA. So it is possible that people at headquarters from that briefing did not understand temperature was a concern?

Mr. McDONALD. I guess it is possible they could have.

General KUTYNA. Is it probable?

Mr. McDONALD. I don't know if it is probable, because we put it as the first bullet of why we thought that was

<sup>171</sup> Rogers Commission Report, Volume V, pp. 1051-52.

<sup>172</sup> Cmte Hgs, Transcript, June 12, 1986, p. 138.

<sup>173</sup> Letter from Brian Russell, Manager MTT SRM Ignition System to James W. Thomas, Marshall Space Flight Center, August 9, 1985.

our highest concern, and if that hadn't have happened, we wouldn't have had that concern.<sup>174</sup>

The briefing recommended an "accelerated pace" to eliminate SRM seal erosion but concluded that "it is safe to continue flying existing design as long as all joints are leak checked with a 200 psig stabilization pressure, are free of contamination in the seal areas and meet O-ring squeeze requirements." Sometime thereafter, Mr. Weeks reported to Mr. Moore on the briefing, indicating that it was safe to continue the program and that it was not "an issue that ought to ground the fleet."<sup>175</sup>

In evaluating the information presented at the August 19, 1985, briefing, the Rogers Commission found:

The O-ring erosion history presented to Level I at NASA headquarters in August 1985 was sufficiently detailed to require corrective action prior to the next flight.<sup>176</sup>

The current NASA administrator concurs in the finding.<sup>177</sup>

Despite the clarity of the Commission's conclusions, none of the participants at this meeting (all with technical backgrounds)—NASA or Thiokol—recommended that the Shuttle be grounded until the problem with the seals was solved.<sup>178</sup> Rather, as noted above, the unanimous recommendation was to accelerate the efforts to fix the problem but continue flying. In adopting this course, did NASA take steps to seek a solution that was reasonably commensurate with a threatened failure of a criticality 1 item? Mr.

<sup>174</sup> Rogers Commission Report, Volume V, pp. 1595-96.

<sup>175</sup> *Ibid.*, p. 1052. See also, Cmte Hgs, Transcript, June 12, 1986, pp. 143-44, and July 24, 1986, p. 90. A conflict in the testimony arose on the question of the briefing Mr. Weeks provided Mr. Moore following the August 19th meeting. According to the testimony presented by Mr. Weeks, "I briefed on the results of that [meeting] and told him about the briefing and showed him the briefing [documents]." *Ibid.*, June 12, 1986, p. 143. Mr. Moore disagreed with this recitation of the facts (*Ibid.*, July 24, 1986, pp. 89-91):

Mr. SCHEUER. Are you telling us that you didn't receive a briefing from Mr. Weeks and that you didn't receive the briefing documents from Mr. Weeks that was given to headquarters by the Thiokol officials?

Mr. MOORE. To my recollection, the first time I remember seeing that document was on August—was on January 29th or January 30th, right after the Challenger accident. I was shown a document which contained the briefing material. It also subsequently came up in one of the earlier discussions with Chairman Rogers and his Commission is the other time I have seen some of that.

Post-accident was the first time I had, to my knowledge, as I said, seen that particular briefing. I had not sat down and been given a briefing on the Thiokol presentation on August 19th.

Mr. Weeks verbally said that the meeting was held that day on August 19th and that in effect that he felt comfortable with the overall conclusions, although he did have one more concern. He felt he wanted to talk to somebody else at Marshall and he did, I believe, talk to Mr. Hardy and said that he thought based on the data and also on the Titan success that in fact there was an acceptable position as far as he was concerned and that is where I left the information and that was the information I was given.

Mr. SCHEUER. He didn't indicate the kind of depth of concern that would have led you to believe that additional time was needed or that additional resources needed to apply to some of these problems before lunch?

Mr. MOORE. No sir. I did not get the feeling that we should have grounded the Shuttle fleet prior to the next flight as a result of that particular briefing.

In a subsequent interview with staff, Mr. Weeks recanted his earlier statement and acknowledged that he did not show Mr. Moore a copy of the briefing document and that to the best of his knowledge Mr. Moore did not see this document until after the Challenger accident. Moreover, Mr. Weeks stated that he did not tell Moore specifically that Morton Thiokol was calling for an accelerated pace to eliminate the seal erosion problem nor did he state that additional resources were needed to be committed to solve the problem.

<sup>176</sup> Rogers Commission Report, Volume I, p. 148.

<sup>177</sup> Cmte Hgs, Transcript, June 12, 1986, p. 129.

<sup>178</sup> *Ibid.*, June 17, 1986, pp. 97-8, 101.

Moore, when asked what he would have done had he received the oral briefing and reviewed the briefing document responded:

I believe that looking at the document and looking at some of the issues that were cited about criticality 1, flight safety issues and mission success issues that came out in the series of the document there, I believe we would have initiated a formal team to go off and take a much more concentrated look at it.

So I believe my actions would have been to form a team of experts to assess this data and to make recommendations on what our course of action should be at this point in time.<sup>179</sup>

Unfortunately this team of experts was not formed until after the Challenger accident. Rather, NASA proceeded on the course summarized in the following exchange between Chairman Roe and Michael Weeks:

Mr. ROE. Therefore, there are a group of people—whom ever they were—that participated at this particular meeting, reviewed these facts that were available, and they determined two things, according to your testimony. One, they determined that if everything—if they had their “druthers,” or whatever the case may be—it would take two years in their judgment to be able to correct that; but in spite of that decision they took and made the second judgement. And the second judgement, well, we can continue to fly. We’ll start the mechanisms going to get this corrected, but we can continue to fly until we get that done. Isn’t that the decision that was made, according to what you’re saying?

Mr. WEEKS. That is correct.

Mr. ROE. Therefore, some people who were at that specific meeting had to be the people who made that specific decision.<sup>180</sup>

In attempting to assess the reasons for NASA Level 1 managers not adopting a more aggressive posture to the O-ring problem, it is suggested that insufficient information was communicated to top.<sup>181</sup> However, as Deputy Acting Administrator Graham observed:

They could have transmitted the information in a higher profile way, but also as engineers, as managers at headquarters, there was certainly a responsibility to perceive the significance of this.<sup>182</sup>

There was plainly a failure of NASA technical managers, and for that matter those at Thiokol, to grasp the seriousness of the problem. As former Shuttle Program Manager Robert Thompson observed:

<sup>179</sup> Ibid., July 24, 1986, pp. 91-2.

<sup>180</sup> Ibid., June 12, 1986, p. 141.

<sup>181</sup> The issue of whether communications are filtered so that important information is prevented from reaching decision-makers is addressed in Section VI.B.2.b.

<sup>182</sup> Cmte Hgs, Transcript, June 17, 1986, p. 207.



Sometimes these problems are very subtle. Sometimes they stand up and shout louder than at other times. Frankly, this time I think it was standing up and shouting pretty loudly.<sup>183</sup>

Why then did top technical managers in the Office of Space Flight at NASA Headquarters (Level I), Johnson Space Flight Center (Level II), and the Marshall Space Flight Center (Level III) fail to take stronger action? (See VI. A.1.f.) The answer may be simply poor technical decision-making, perhaps in combination with a type of collective rationalization described by Larry Mulloy:

You asked why wasn't more done. You know, in the six years previous. And I have had that question posted to me many times in the last four months, and I have asked it of myself many times since the tragic accident. And my answer has been in hindsight, obviously, more should have been done.

The turning, I think we started down a road where we had a design deficiency. When we recognized that it had design deficiency, we did not fix it. Then we continued to fly with it, and rationalized why it was safe, and eventually concluded and convinced ourselves that it was an acceptable risk.

That was—when we started down that road, we started down the road to eventually having the inevitable accident. I believe that.<sup>184</sup>

#### d. Change Control Process

##### *Issue 1*

Has the pressure to maintain operational flight rates and schedules for the Shuttle compromised the hardware Change Control Process?

##### *Findings*

1. When NASA declared the Space Shuttle to be an operational system, additional pressure to increase flight rates impacted other aspects of the overall program such as the ability to implement, evaluate, test, and certify changes in hardware design.

2. As a result of attempting to operate the Shuttle at increased flight rates, controlling other aspects of the program such as the flight production process and manifest also became a more complex and difficult aspect of program administration.

##### *Recommendations*

1. NASA must reconsider its efforts to categorize the Shuttle as an operational transportation system.

2. The Configuration Management System designed to control such changes must be reexamined by NASA as to its effectiveness in assuring that all hardware changes take place in a safe and reliable fashion.

<sup>183</sup> Ibid., July 24, 1986, p. 117.

<sup>184</sup> Ibid., June 17, 1986, pp. 215-16.

### *Discussion*

The Rogers Commission noted that, "Following successful completion of the orbital flight test phase of the Shuttle program, the system was declared to be operational."<sup>185</sup> The Commission found that as a result, NASA reduced its safety, reliability and quality assurance activities related to the Shuttle. The Commission report goes on to note that this reasoning was faulty; "The machinery is highly complex, and the requirements are exacting. The Space Shuttle remains a totally new system with little or no history."

Program officials frequently find it necessary to consider changing existing hardware designs or production processes. Such changes can be required for a number of reasons, including: to correct the deficiency in a component; to improve a component's performance or the length of this operating life; to enhance the ease of maintaining the component; or to reduce the cost of manufacturing, servicing, or processing the component. Typically, change proposals originate from a manufacturer and are reviewed by the cognizant NASA field center and frequently by the Level II Program Office at the Johnson Space Center as well. In his review process, NASA compares the cost and schedule impacts of the proposed change against the performance improvement that is anticipated. Of particular concern are the safety aspects related to the change (e.g., What analyses and tests must be conducted to insure that the change does not directly or indirectly have a negative impact on the systems safety or reliability?).

It is clear that these activities or steps in the process of implementing essential changes are complex and time consuming, especially if the components to be evaluated are some of the larger and critical elements of the Space Shuttle. Therefore, it is the Committee's view that until such time as all elements of the Space Transportation System can be fully evaluated through extensive flight testing and trend analyses, it is premature to impose an operational flight schedule on the system in a manner comparable to that imposed upon, for example, an air transportation system.

### *Issue 2*

Is the change control process sufficiently defined for all elements of the Shuttle system?

### *Findings*

1. The NSTS engineering and process change guidelines are, for the most part, sufficiently well-defined for the majority of the subsystems that comprise the Space Shuttle.

2. NASA gives the same level of scrutiny to changes involving a minor component (such as moving velcro strips in the Orbiter) as those involving mission critical elements of flight hardware.

### *Recommendation*

NASA should review its change control process to determine the usefulness of differentiating between minor changes and significant changes.

---

<sup>185</sup> Rogers Commission Report, Volume I, p. 159.

*Discussion*

NASA's Change Control System is shown in Figure VI-4. From the chart, it is evident that the success of the system is highly dependent on the information flow among the various levels of management control.

SPACE SHUTTLE CONFIGURATION MANAGEMENT  
CHANGE CONTROL FLOW

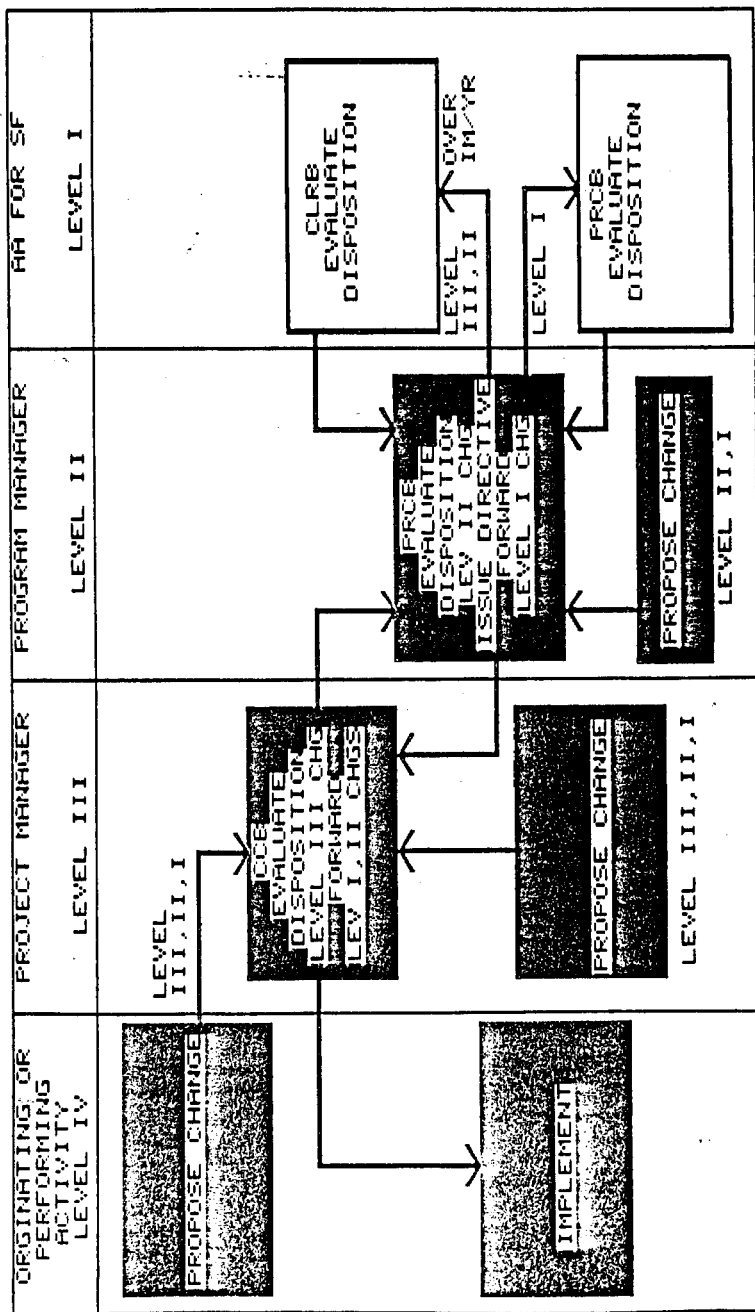

AMIC2-SSCHT.SKE

Figure VI-4

The Configuration Management System Requirements are documented in JSC 07700 Volume 4, entitled "Configuration Management Requirements," dated March 2, 1973. Changes to this document have periodically been issued over the course of the program. The configuration management system defines requirements for all levels of management within the NSTS program. A baseline set of requirements is defined for each level of management (Level I through Level IV). This baseline establishes what is to be accomplished at each level of management and established the controlling procedures that supposedly prevent deviations from the baseline program. This baseline program is specified for each flight and includes specifications on payloads for each flight as well.

Changes to the flight and system requirements and the acceptance baselines are made, according to NASA, only by directives issued by the Program Requirements Control Board at Level I and Level II and the Change Control Boards. For example, there is an Orbiter Avionics Software Control Board (OASCB) that has joint Level II and Level III authority for managing the program-wide requirements for Shuttle computer hardware and software systems as part of the Orbiter project. The Board also assures the correct configuration of the software within the Orbiter avionics system for all vehicle and test operations.

Design changes at the contractor level are processed through several levels of technical and managerial reviews. Design and engineering changes on the Orbiter, for example, undergo Technical Status Reviews (TSR's), Avionics Status Reviews (ASR's), Preliminary Design Reviews (PDR's), Critical Design Reviews, (CDR's), Design Certification Reviews (DCR's), and numerous special meetings of NASA and the Rockwell management are utilized to review issues and concerns about any design drawing or specification. According to Rockwell,<sup>186</sup> "Changes are reviewed at a TSR or ASR and the Change Control Board for approval. Any outstanding design dispute is tracked as an open action until it is resolved by Rockwell and NASA management."

The Committee questions, however, whether the complex and extensive processes involved in NASA's change control management system allow for sufficient distinction between minor changes and the significant changes. For example, the systems requires the same level of management attention to as minor a change as moving velcro strips on the Orbiter as it is applied to all Criticality 1 item such as changing a turbo-pump on the SSME.

## 2. ORGANIZATION AND POLICY MANAGEMENT

### a. Management Structure

#### *Issue 1*

Does the management of the Shuttle Program adequately define the lines of authority and are managers given authority commensurate with their responsibilities?

---

<sup>186</sup> Responses to Committee Questions, dated August 22, 1986.

### *Finding*

The management of the Shuttle Program is complex and diversified and it is not always clear who has authority or responsibility. NASA's "lead center" concept has resulted in placing the management of the program at JSC, one of three centers participating in the program; however, because Johnson does not have control of the other centers' resources, the NSTS program manager's authority to manage the program is limited and the responsibility is unclear.

### *Recommendation*

NASA should restructure the Shuttle Program management to define clear lines of authority and responsibilities. This restructuring should take into account the special role each center must play and be especially sensitive to the need for the cooperation and support of all the participants to achieve a common goal. NASA should give special consideration to moving the Program Manager to NASA Headquarters to avoid the confusion and inter-center rivalry that result from having a large multi-center program managed out of one of the participating centers.

### *Discussion*

The line of management responsibility, authority, and accountability for NASA programs is from the Administrator to the Associate Administrator to the Field Center Directors, who delegate implementation authority to a program/project manager. JSC has been designated the "lead" center for the NSTS Program and has the responsibility for systems engineering and integration, operations integration, and management integration. Marshall has the responsibility for the propulsion system and Kennedy has the responsibility for launch operations.

The Associate Administrator for Space Flight (the Level I program manager) performs oversight over the program but doesn't have the technical staff to effectively manage the program. The NSTS Program Manager, i.e. the Level II manager at JSC, functions as a program coordinator; he is responsible for integrating the various program elements and he controls all the project interfaces. He clearly does not control all the program elements since the individual (Level III) Project Managers are accountable to their Center Directors who are in turn accountable to the Associate Administrator who controls the funding. For example, the Level II manager told the Rogers Commission that he was unaware that the SRB Project Office had procured additional Solid Rocket Motor casings to be used for testing of the joints;

Now it turns out that the budget for that kind of work does not come through my level II office. It is worked directly between the Marshall Center and NASA Headquarters and there again had I been responsible for the budget for that sort of work, it would have to come through me, . . . .<sup>187</sup>

---

<sup>187</sup> Rogers Commission Report, Volume V, p. 1490.

The witnesses who addressed the management issues at the Committee hearings had differing philosophies regarding the best possible solution; however there was general agreement that the present system tended to cause confusion. There was also strong sentiment for strengthening the headquarter's role. Mr. Jesse Moore, former Associate Administrator for Space Flight, testified:

I think we need to go back and make sure we clearly define the roles of NASA headquarters, the roles of the centers in the overall management of the STS.

I think we need to re-look at that kind of interaction and the kind of specific roles, responsibilities, to ensure that authority and responsibility is commensurate in terms of the role definitions for the various levels of management in NASA.

I think we need to look at strengthening NASA headquarters. I would say that in my tenure a NASA headquarters we had a decline in staff in the Office of Space Flight. It was a decline in the number of staff, and I think we need to look at what is the proper level of staffing requirements to do this particular job.

I also think we need to look to make sure we get as much technical expertise into the Office of Space Flight as we possibly can.<sup>188</sup>

General Stafford, a former Gemini and Apollo astronaut, also stated: ". . . I guess I was never comfortable with the lead center type of management structure, after having seen how satisfactorily Apollo worked."<sup>189</sup> (Note: The Apollo program was managed out of headquarters.)

With regard to the appropriate role of the Program Manager (Level II), there was not a clear consensus. In discussing the Rogers Commission's recommendations, General Abrahamson stated:

. . . However, I would also like to point out that many of these recommendations have long been incorporated in NASA management procedures. The Program Manager, by definition, has the necessary authority to get the job done.<sup>190</sup>

When asked if the program management should remain at JSC, Mr. Moore, who is currently Director of JSC, replied:

I think that is certainly a topic that is going to be studied very, very carefully.

I think there are a couple of options that can be looked at that would keep the major parts of program management that has been in operation at the Johnson Space Center at the Johnson Center.

There are a lot of tools, roots and capabilities. I think, on the other hand, there should be some looks at the Office of Space Flight for finding some way to strengthen

<sup>188</sup> Cmte Hgs, Transcript, July 24, 1986, pp. 80, 87.

<sup>189</sup> *Ibid.*, June 25, 1986, p. 128.

<sup>190</sup> *Ibid.*, July 24, 1986, p. 11.

the overall program management in the Office of Space Flight.

And one concept might be to have a Shuttle Program Director within the Office of Space Flight and working with the Level II program office at the Johnson Space Center.

My answer is, I believe the Level II program office, with some strengthening, and the level I program office, with some strengthening—we can make it work and it should remain at the Johnson Space Center.<sup>191</sup>

This was in direct contrast to the view held by John Yardley, former Associate Administrator for Space Flight. In discussing the Rogers Commission's recommendations, he stated:

The one in particular that I think I have some background in that I think is not correct is they are trying to strengthen the authority and responsibility of the Program Manager at Johnson. Let me just relate what happened when I went to NASA.

I hadn't been there but a couple of weeks and one of the other centers called me and said, "Hey, the Program Manager wants to take 15 million of my money and put it on the Orbiter." It became immediately apparent to me to have one of the center people handle the funding decisions was not going to be in the best interests of cooperative technical activity.

So I pulled the final decisions on the money to Washington, where I think they still are . . .<sup>192</sup>

Major Slayton made a similar observation concerning the problems with having a multi-center program managed at one of the field centers:

. . . I think when you look at relationships between the centers and how the organization is structured; and you could say it could be restructured so you don't have inter-center jealousies interfering with the communications channel.

A lead center concept where Level II is viewed by the other centers as being another center instead of having its headquarters' level is one reference I would make.<sup>193</sup>

Major Slayton went on to say that any organization could work with the proper people:

A lot of it is in the management attitude; but again, my opinion is, you can make any organization work if you got the right people, and if you don't have the right people I don't care how you organize it, it will not work, so you still end up dealing with individuals.<sup>194</sup>

---

<sup>191</sup> Ibid., p. 99.

<sup>192</sup> Ibid., July 23, 1986, p. 10.

<sup>193</sup> Ibid., June 25, 1986, p. 101.

<sup>194</sup> Ibid.



Other witnesses also alluded to the problems with inter-center rivalries under the current system and the break down of esprit de corps. Mr. Moore called for a new effort to re-instill the team spirit:

I believe an approach to that has got to be building team work, again, to make sure—the Shuttle program involves many elements, many contractors, many NASA centers, all playing together as a team.

I believe we have to go back and re-instill in our people, in our participants, a team work approach . . .

I think the overall structure of the Shuttle program is obviously built upon people and, you know, there are humans all the way up the chain, all the way from the engineers at the subcontractors to the engineers at the contractors, the NASA centers and so forth.

I think we have got to make sure that each of those participants in the program feel a dedication, feel a dedication to safety, feel a dedication to the program that they are making a valuable contribution and I think we need to do that by personal communications as well as trying to look at our structure to make sure we have not defined something that will at least maybe encourage, tend to encourage communications breakdown.<sup>195</sup>

General Abrahamson made the following observations with regard to changing organization:

It is true that when any organization is formed, it is formed to help you accomplish a particular task. By the same token, once it is there, it develops momentum and procedures and impediments sometimes to exactly what you would like to have, a dynamic and modifying organization for the challenges of the future. This is always difficult.

I believe that we had an organization that was designed for the development of the Shuttle, and when we got there, since it was only the second flight, that we had a tremendous change of attitude that we had to be able to create, and that was to create an organization that would think in terms of operations of the Shuttle and overcome the flight test problems.<sup>196</sup>

## *Issue 2*

Are astronauts adequately represented in management?

### *Finding*

The Committee finds no evidence that astronauts are denied the opportunity to enter management if they so choose.

### *Discussion*

The Rogers Commission has suggested that NASA should make greater use of astronauts in management; however, the Commis-

<sup>195</sup> *Ibid.*, July 24, 1986, pp. 69-70.

<sup>196</sup> *Ibid.*, p. 17.

sion report provides no basis for that recommendation. Astronauts generally have shown little interest in going into any kind of desk job, including management positions, until such time as their active flying days end. At that time, management jobs within the astronaut program become attractive alternatives to some; however, opportunities in this area are naturally limited. Major Slayton expressed this very well when he testified about his experience with the Mercury Program:

I had the misfortune at that time of having been grounded due to a medical problem so I was elected to take over the management of the astronaut corps, a job I didn't particularly care about, but it was the next best thing.<sup>197</sup>

Mr. Nelson asked the astronauts whether any of them felt there was a "modus operandi" within NASA that excluded either active or former astronauts from the management structure. General McDivitt stated he had seen no bias in his three years as Program manager for the Apollo Program. Mr. Nelson then asked Deke Slayton if he had ever seen any bias in NASA and Major Slayton confirmed that he too saw no evidence of bias against astronauts in management. General Abrahamson observed:

Throughout my tenure, astronauts were in key program office positions and one served as an Assistant Associate Administrator in the Office of Space Flight. . . .<sup>198</sup>

There was agreement among the astronauts that the astronaut office should be moved up higher in the organization. General McDivitt summed up the astronauts' position:

I think I would recommend that the Flight Crew Operations Directorate be moved up to report to the Center Director as well as the Flight Operations Director.

I think both of those organizations are very key to flying, and having them go through another layer of management before they get to the Center Director creates a filter which is not necessary or desirable for either one of them.

I think it also gets them on the same level as the engineering organizations within the manned spacecraft center, and gives them better access to the program.<sup>199</sup>

#### b. Communication

##### *Issue 1*

Are there adequate opportunities to communicate problems within the Shuttle Program management structure?

##### *Finding*

There are many regularly scheduled meetings and teleconferences at all levels of management throughout the Shuttle Program. In addition, "special" meetings and telecons are routine. No evi-

<sup>197</sup> Ibid., June 25, 1986, p. 11.

<sup>198</sup> Ibid., July 24, 1986, p. 11.

<sup>199</sup> Ibid., June 25, 1986, p. 52.

dence was found to support a conclusion that the system inhibited communication or that it was difficult to surface problems.

### *Discussion*

Every day at noon central time a teleconference is held among all NASA Space Shuttle Program participants. This is the daily "special" Level II PRCB (Program Requirements Change Board) meeting and includes, among others, all the managers of the various program elements, the JSC Directors of Flight Crew Operations, Mission Operations, Engineering, Mission Support, SR&QA, and Space and Life Sciences. Program status, urgent problems, and program requirements are brought up at this meeting. The PRCB convenes by teleconference on alternate Fridays to discuss all other (less urgent) program issues; in addition, other special meetings are called by the PRCB secretary when deemed necessary.

Each of the supporting organizations also has regularly scheduled meetings, often by teleconference when they involve more than one location. Regularly scheduled (often daily) teleconferences are also held between various directors and managers.

Level I at headquarters conducts daily status meetings and also participates in the noon teleconference. These meetings plus all the Flight Readiness Reviews provide ample opportunity to surface problems.

### *Issue 2*

Is too much information being disseminated so that important information is lost?

### *Finding*

Large amounts of information are disseminated on a routine basis, often with little or no indication of its importance to all of the recipients.

### *Recommendation*

NASA management should review the process of providing information on significant actions so that awareness by concerned managers is assured.

### *Discussion*

In a NASA briefing to staff on Mission Operations (May 21, 1986), NASA managers revealed that they routinely received information copies of all sorts of memoranda, such as directives, requests, approvals for changes, etc. Often the individual receiving these copies had no direct involvement with the specific subject of the memoranda, and they acknowledged that it was entirely likely that an important piece of information could cross their desk without their awareness.

### *Issue 3*

Are communications filtered so that important information is prevented from reaching the decision makers?

### *Finding*

NASA managers delegated the responsibility for making technical judgments to lower level managers or assistants. Therefore, the information that reached the top decision makers was "filtered" in that it was interpreted by others that were presumed to have more specialized experience or expertise in a given area. There is no evidence that middle level managers suppressed information that they themselves deemed to be significant. In fact, as discussed in the Section on Technical Expertise, the failure was not the problem of technical communications, but rather a failure of technical decisionmaking.

### *Discussion*

It is typical in any large, complex organization that as managers rise higher in the organization the scope of their responsibilities broadens to encompass technical areas beyond their own specialized expertise. Therefore they must rely increasingly on the technical judgments of lower level managers or assistants. There is the additional risk of subordinates' reluctance to transmit unpleasant information upwards; however, it is not evident that NASA managers suppressed information about problems they themselves understood.

Throughout the hearings, witnesses said that had they known about the seriousness of the problem with the SRM joint, they would have stopped the flights; or (in their opinion), had the decision makers known about it the flights would have stopped. The witnesses acknowledged that the problems with the SRM joint had been briefed at all levels, but always in a way that didn't communicate the seriousness of the problem; it was not viewed as life-threatening. Yet the witnesses appeared reluctant to attribute this to poor technical judgments on the part of the managers or technical staff with expertise in propulsion, preferring instead to blame it on poor communications or a poor "decision-making process."

Mr. Scheuer questioned Jesse Moore specifically on this point when he asked, referring to Mr. Weeks' summary of the August 19 meeting, "Was it a failure of decision-making on his part or communications on his part?" Mr. Moore responded:

Sir, I think that in a position like Mr. Weeks is in, we have to work as a team, for example, and people have to make assessments on situations and I think Mr. Weeks looked at the data and his assessment was that he thought we had a program adequate to cover the activities in the SRB and he believed that after he had talked to the people at Thiokol and he also believed that, I think, after talking to the people at Marshall and I believe his position was that in fact was an acceptable posture for him to take. Part of his responsibility is to make technical judgments.<sup>200</sup>

Mr. Moore went on to explain that he believed the lack of understanding of the SRB joint extended throughout the agency:

---

<sup>200</sup> Ibid., July 24, 1986, p. 94.

I would say, sir, in looking up and down the system and what has been determined about the SRB from the many analyses and work that has been done in the past, I don't think the system all the way from day one of the program really understood all the implications of how the SRB joints worked and I think that we have learned, all of us have learned, an awful lot about the SRB . . .<sup>201</sup>

And again referring to the August 19 meeting:

That was a report from my deputy (Mr. Weeks), that he believed the situation was acceptable as far as assessment of the data presented to him, and I trust the people in the organization to make those kinds of judgments.

We have to make those judgments on a day-to-day kind of basis, but I did hear at Flight Readiness Reviews, as everybody as a member of the overall Shuttle team heard about issues associated with the O-ring problem. I believe the first time this was experienced on the Shuttle Program was all the way back to flight 2 . . . I did not, as the head of the Level I office, believe the problem with the SRB O-rings was serious enough to consider stopping the launches.

If I did, I would have stopped the launches, sir.<sup>202</sup>

Mr. Scheuer again asked Mr. Moore to identify where the failure was, "Was it in your being communicated with by Mr. Weeks? Was it a failure of judgment on Mr. Weeks' part that all systems were go? Where was the failure?" At that point, Mr. Moore blamed the failure on communications:

I think in looking at the whole situation, I think there was a failure to communicate the technical seriousness from the contractors involved in this program through . . .<sup>203</sup>

But, Mr. Scheuer suggested that the contractors had communicated the problem at the August 19th meeting. Mr. Moore then suggested that perhaps someone should have made a stronger statement; however, in their collective judgment it was not a serious problem:

On the basis of the specific August 19 briefing that was presented, I believe there should have been a stronger statement made to me that we have a much more serious problem by Mr. Weeks or any of the people who attended that briefing. Mr. Weeks was not the only one at the briefing. There were others at the briefing who had some knowledge about the SRB . . .

I don't recall the specific list of attendees at that particular meeting, but people that were in the overall propulsion area of the office of space flight—and the office of space flight is level one—that is the level one—people who had experience in this thing.

<sup>201</sup> Ibid., p. 95.

<sup>202</sup> Ibid.

<sup>203</sup> Ibid., pp. 96-97.

I believe if they felt after that August 19th briefing that we had a problem, that the system should be grounded, that somebody would have come and said, "We have got a problem serious enough to ground the Shuttle flight."

That did not occur, and I believe it was based on a collective set of judgments that we did not believe the problem was as serious.<sup>204</sup>

The Committee finds no reason to doubt Mr. Moore's observations that no one within NASA understood the problem with the O-ring and accepts his conclusions:

In hindsight, I think we should have taken much stronger action after the August 19th briefing . . . if I had the knowledge then that I have today, we would have grounded the fleet.

I did not have it at the time.<sup>205</sup>

In hindsight, the August 19th briefing, as well as the January 27th telephone conversation clearly identified a serious problem. Perhaps the Thiokol engineers understood the seriousness of the problem; however, Thiokol's own summary and recommendation at the conclusion of the August 19th briefing stated:

Analysis of existing data indicates that it is safe to continue flying existing design as long as all joints are leak checked with a 200 psig stabilization pressure, are free of contamination in the seal areas and meet O-ring squeeze requirements.<sup>206</sup>

This conclusion was accepted by all who heard the briefing, and this was the information that was transmitted throughout NASA. The evidence does not support a conclusion that the top decision makers would have arrived at a different conclusion from the managers at Marshall and the Level I managers with propulsion backgrounds. (For additional discussion on this issue, see Section VI.B.1.c.)

### c. Safety, Reliability and Quality Assurance

#### *Issue 1*

Is NASA's decision to establish a new Office of Safety, Reliability, and Quality Assurance appropriate and, if so, what should its role be?

#### *Finding*

The Committee finds that the Rogers Commission recommendation that NASA should establish an Office of Safety, Reliability and Quality Assurance that reports directly to the Administrator is indeed appropriate. However it is not clear what the activities of this office will encompass.

<sup>204</sup> Ibid, p. 98.

<sup>205</sup> Ibid.

<sup>206</sup> Rogers Commission Report., Volume II, p. H-95.

### *Recommendations*

1. The Associate Administrator for Safety, Reliability and Quality Assurance (SR&QA) should provide to the Committee the agency's draft plan delineating the organization, goals, implementation strategies and resource requirements of the office of SR&QA.

2. After the Office of SR&QA is fully operational, the Committee will wish to continue oversight over its activities.

### *Discussion*

Chapter 7 of the Rogers Commission report deals with the subject entitled "The Silent Safety Program." The Commission identified shortcomings in NASA's overall Safety, Reliability and Quality Assurance Programs, and recommended the formation of a separate Office of Safety, Reliability and Quality Assurance that would report directly to the Administrator. The role of safety and quality assurance in the decisionmaking processes associated with Shuttle flight production requirements has been relatively undefined and ambiguous. The formation of a centralized coordination and control organization should serve to remedy the situation. As the Rogers Commission report notes, ". . . No one thought to invite a safety representative or a reliability and quality assurance engineer to the January 27, 1986 teleconference between Marshall and Thio-kol."<sup>207</sup>

On July 8, 1986, the Administrator established the position of Associate Administrator for Safety, Reliability and Quality Assurance, and briefly delineated the responsibilities of this office in NASA's responsive document to the Rogers Commission report.<sup>208</sup>

According to NASA, the purpose of this office is to strengthen the role of the SR&QA functions across all the the NASA programs. This will be accomplished by establishing centralized coordination under the Associate Administrator for SR&QA who reports directly to the Administrator on all pertinent matters related to the NSTS. The Associate Administrator is chartered to examine the adequacy of the agencies resources in these areas and to make recommendations for improvements as appropriate. Functional organizations that were previously under the purview of the Chief Engineer's office will now report directly to the Associate Administrator for SR&QA.

The major contractors to the NSTS agree with the Commission's recommendation to form a separate NASA SR&QA organization reporting directly to the Administrator. They are, however, of the opinion that responsibility for the work required to recommend or implement changes or modifications in the quality assurance area must remain with Level III and the contractors themselves.

The Committee does not argue with the contention that strong SR&QA capabilities must reside at the contractors' plants. Further, the Committee supports NASA's efforts to enhance its in-house capabilities in order to improve the agency's monitoring and oversight capabilities in the areas of SR&QA. Strengthening Headquarter's ability to provide guidance and centralized coordination in the

<sup>207</sup> *Ibid.*, Volume I, p. 152.

<sup>208</sup> NASA Response to Rogers Commission, July 14, 1986, p. 20.

areas of configuration management, product reliability and quality assurance and risk management, are essential to returning the Shuttle to flight readiness condition.

### *Issue 2*

Has NASA applied sufficient resources to support adequate SR&QA efforts within the NSTS program?

### *Findings*

1. The Committee finds that reductions in NASA civil service personnel that have occurred over the past decade have adversely impacted the agency's ability to maintain the appropriate level of oversight control of the Safety, Reliability and Quality Assurance activities within the NSTS.

2. NASA has become increasingly dependent upon outside SR&QA support from the Department of Defense (Defense Contract Administration Services [DCAS] and Air Force Plant Representative Office [AFPRO]) and contractors.

3. NASA has reduced or reassigned to other program areas in-house safety, reliability and quality assurance tasks such as testing, analyses and instrumentation and has reduced or shut down in-house facilities for performing SR&QA research and technology development. The degree to which these factors have adversely impacted the safety, reliability and quality assurance activities within the NSTS program has not been adequately assessed.

### *Recommendations*

1. NASA should establish and maintain a strong and effective SR&QA Program. Continuing support for such a program must come directly from the Administrator.

2. Although it is appropriate to establish strong contractor capabilities in the areas of SR&QA the internal oversight responsibilities and coordination of SR&QA tasks must be the responsibility of NASA itself. In order to assure that the appropriate interfaces among the various subsystem elements that comprise the NSTS, are maintained, a sufficient complement of NASA SR&QA management and support staff must be available to perform the necessary oversight and coordination tasks.

### *Discussion*

Reductions in force over the past several years have reduced personnel across the agency from a complement of some thirty-six thousand people down to twenty-two thousand people. A disproportionate decline in Reliability and Quality Assurance (R&QA) staffing occurred as a result of these reductions. In the Shuttle program, many of the quality control functions and government inspection activities have been performed by contractors in conjunction with the Department of Defense support personnel (DCAS and AFPRO). NASA has expressed some concern about their ability to maintain adequate in-house staffing in these areas. The total number of civil servant employees within NASA dedicated to the SR&QA program



is presently about 500 professionals.<sup>209</sup> This represents a reduction of 71% from the 1970 complement.

NASA attributes this reduction to the termination of "in-house flight programs, along with the transfer of certain functions . . . to other organizations within the NASA centers." In their response to Mr. Roe's inquiry,<sup>210</sup> NASA makes the following statement:

"Even though we had a reduction in R&QA personnel, our detailed review of the quality operation did not reveal that we missed any of the quality control check points which may be contributed to the accident."

The Committee cannot support NASA's assessment on this matter. Although NASA may argue that the quality control check points for the certification tests required on the ambient and induced temperature effects on the O-ring seals were checked off by the QA representative at Thiokol as having been satisfactorily completed, in actuality these tests were never performed. To what extent this failure of the QA function to do its job contributed to the accident may be questioned, but the fact that the control didn't work in this case cannot be denied.

It should be noted, however, that according to some of the prime contractors, SR&QA staffing has actually improved over the years.<sup>211</sup> For example, at the Rocketdyne Corporation, there has been an increase in QA staffing to a level that represents nearly 40% of the corporation's manufacturing staff.

### *Issue 3*

Are the responsibilities of safety engineers and design engineers adequately specified within NASA's "risk management" program?

### *Finding*

The roles of safety, design as well as reliability engineers are not adequately and uniformly defined throughout the NSTS program. In some cases, the Committee learned that safety engineers were not participating in major decisions related to flights of the Shuttle.

### *Recommendations*

It should be the responsibility of the new Associate Administrator for SR&QA to fully specify the roles of safety and reliability engineering as well as quality assurance personnel within the NSTS program so that all critical aspects of the program and decisions related to the adequacy of hardware and subsystem performance are fully reviewed by these disciplines.

### *Discussion*

The function of the safety engineers within the NSTS program has been to determine whether or not certain prescribed tests, analyses, and design descriptions have been followed appropriately

<sup>209</sup> Discussion with the NASA Chief Engineer's Office, May 13, 1986. Also, Cmte Hgs, response to question by Mr. Roe, Transcript, June 11, 1986, pp. 59-60.

<sup>210</sup> Cmte Hgs, response to question by Mr. Roe, Transcript, June 11, 1986, pp. 59-60.

<sup>211</sup> Telephone Conversation, August 13, 1986.

as they relate to safety concerns, using the techniques of HA. The safety office has not been significantly involved in the engineering design efforts. If an engineering problem arises that could effect the safety of the overall system, it is the responsibility of design engineering teams to perform technical evaluations rather than having these analyses performed by the safety engineers. Prior to the Challenger accident, the safety program did not have the personnel, facilities or expertise to review decisions by design engineers that the O-ring erosion problem was a manageable risk. Even though this erosion was a continuing problem, there was, according to testimony provided to the Rogers Commission, no second set of "eyes" available to question waiver applied to this problem.<sup>212</sup>

#### *Issue 4*

Does the SR&QA program require improved coordination between centers, contractors and NASA Headquarters?

#### *Findings*

1. Although guidelines have been published that describe the responsibility of contractors' in the areas of SR&QA,<sup>213</sup> NASA's guidelines do not adequately distinguish these various activities as distinct disciplines requiring specialized skills and centralized coordination.

2. In its review of the agency's reliability and quality assurance programs as they relate to the Space Shuttle, the Committee found there was little commonality among the cognizant officials at MSFC, JSC, KSC, and Headquarters in the perception of the various responsibilities associated with these separate and distinct disciplines.

#### *Recommendations*

1. It is important that a clear delineation of responsibilities for the separate SR&QA disciplines be appropriately documented. It is also essential that the relative importance of each of the three separate disciplines be established as an integral part of the NSTS program. These functions are the responsibility of NASA Headquarters.

2. NASA must carefully review the staff and resources devoted to the SR&QA function within NASA and contractor organizations for adequacy. The Administrator shall report to the Committee with his findings and recommendations.

#### *Discussion*

Although the controlling document describing the SR&QA functions for the Shuttle contractors was provided to the Committee, no corresponding document was identified that describes the implementation of these functions for the SR&QA engineers that are direct employees of NASA. NASA contends that the same controlling document applies to agency employees. The specific oversight

<sup>212</sup> Testimony before the Rogers Commission, Mr. Jack Walker, Deputy Director, MSFC Safety Office, April, 1986.

<sup>213</sup> NASA, "Safety, Reliability, Maintainability and Quality Provisions for the Space Shuttle Program": NHB 5300.4 (1D-2), October, 1979

responsibilities of these employees and their independent reviews and analyses requires a more complete delineation in the Committee's view. The Rogers Commission report provides definitions for the SR&QA disciplines.<sup>214</sup> An expansion upon these definitions is required in order to establish a commonality of understanding of the various functions as they apply to the Shuttle program.

The management structure within NASA that coordinates and performs the activities associated with the SR&QA tasks for the NSTS has become decentralized over the past decade. Until recently many of the oversight duties that at one time were handled through Level I were moved to the field centers. Responsibilities for various systems that comprise the Space Shuttle are delegated to the Level III field centers. These centers establish and coordinate SR&QA activities at the contractor facilities. They are also responsible for reporting any anomalies, inconsistencies, or problems to Level II program management.

Until recently, the Office of the Chief Engineer had responsibility for SR&QA activities. For various reasons, the operations of this office in the areas of SR&QA appear to have lost effectiveness, either through reductions of personnel and support of these programs at the Headquarters level or through the diffusion of these functions into various organizations within the operating divisions at the field centers.<sup>215</sup> These changes reduced Headquarter's ability to participate in field center status reviews with the prime contractors, limited the Level I manager's ability to survey the effectiveness of the SR&QA programs agency-wide and reduced the collocation of SR&QA personnel within Headquarter's program offices. The Committee expects that the new Office of SR&QA will be chartered to make appropriate corrections to augment the safety, reliability and quality assurance functions within the NSTS Program.

#### d. Contractor Incentives

##### *Issue*

Key Shuttle contracts (e.g., the Solid Rocket Booster Production Contract and the Shuttle Processing Contract (SPC)) provide incentives both for reliability, integrity, and safety of products and services on the one hand, and for cost and schedule on the other. Do these contracts provide an appropriate balance between the two types of incentives? That is, does NASA utilize contracts to reward and promote operational safety?

##### *Findings*

1. The SPC provides far greater incentives to the contractor for minimizing costs and meeting schedules than for features related to safety and performance. SPC is a cost-plus, incentive/award fee contract. The amount of the incentive fee is based on contract costs (lower costs yields a larger incentive fee) and on safe and successful launch and recovery of the Orbiter. The award fee is designed to permit NASA to focus on those areas of concern which are not sen-

<sup>214</sup> Rogers Commission Report, Volume I, p. 152.

<sup>215</sup> Discussion with the NASA Chief Engineer's Office, May 13, 1986.

sitive to the incentive fee provisions, including the safety record of the contractor. However, the incentive fee dwarfs the award fee—while the maximum value of the award fee is only one percent of the value of the SPC, the incentive fee could total as much as 14 percent of the SPC.

2. During the developmental phases of the Thiokol contract for Solid Rocket Booster production (1980–1983), the contractor received consistent ratings of “Excellent-Plus” or “Superior” under the cost-plus, award-fee contract. NASA contracted with Thiokol on a cost-plus, incentive-fee (CPIF) basis beginning in July, 1983. The CPIF contract pays strictly on the basis of costs, although penalties may be invoked for delays in delivery or for Shuttle accidents due to SRB failure. At the time of the Challenger accident, Thiokol was eligible to receive a very large incentive fee, probably on the order of \$75 million.

#### *Recommendations*

1. NASA should reexamine all Shuttle contracts and report to the Committee with its findings and recommendations on whether more incentives for safety and quality can be built into these contracts. This report should address, *inter alia*, the SRB Production Contract and the SPC.

2. NASA’s new Office of SR&QA should be involved in the procurement and award fee processes, both to establish reasonable guidelines and rewards in new contract and to judge performance of ongoing contracts.

#### *Discussion*

Mr. Robert Thompson, Vice President of McDonnell Douglas, summarized the position of several Committee witnesses when he stated:

I have never detected that a contractor would deliberately infringe on safety for a profit motive.<sup>216</sup>

On the other hand, Thompson also admitted that contracts do vary in the extent of their safety incentives and that, to a certain degree, such incentives can make a difference in operational safety:

. . . the type of safety that we are looking for, for a system like the Shuttle, I think they can be enhanced with these kind of stipulations in a contract. They can’t truly be bought that way.

Certainly you [could] hang a larger incentive toward safety. You may enhance a strong focus on safety and I would not say that it wouldn’t do some good to enlarge those enhancements.<sup>217</sup>

The more difficult question is whether existing NASA contracts, such as the SPC and the SRB Production Contract, strike an appropriate balance between safety incentives and cost/schedule incentives. This question is particularly critical in light of reductions in

<sup>216</sup> Cmte Hgs, Transcript, July 24, 1986, p. 135.

<sup>217</sup> *Ibid.*

NASA's SR & QA programs detailed in Section VI.B.2.c. of this report.

Both Thiokol and NASA witnesses on June 17, 1986, argued that the penalties inherent in the Thiokol contract with Marshall Space Flight Center provided more than adequate incentives for Thiokol to deliver safe, reliable products. These penalties are of two types. Late-delivery penalties amount to \$100-200 thousand per unit. Penalties for mission failures are much larger:

If findings of this Board of Investigation determines (sic) that the cause of the failure is attributed to the Solid Rocket Motor/Motors not performing in compliance with the specification requirements of the contract, a fee reduction of \$10,000,000 for each category I failure and \$5,000,000 for each category II failure shall be deducted from any fee otherwise earned under this contract.<sup>218</sup>

Similarly, in briefings for Committee staff, NASA contract managers have stated that the award fee portion of the SPC, though small, is highly visible and that contractors take the award fee and the semiannual contract ratings very seriously. In NASA's view, high ratings enhance a company's reputation and, therefore, its likelihood of competing effectively for additional contracts.

Nevertheless, there are several reasons to believe that NASA could utilize contractual terms more effectively to enhance program safety. First, there can be no argument, for both the SPC and the SRB contract, that absent a major mission failure, virtually all the financial incentives are tilted toward cost-savings and timely delivery.

Secondly, because of the complex and overlapping division of responsibilities between NASA and its contractors, it is not clear that contractors will be fully penalized even in cases where their actions or their hardware appear to be directly responsible for a mission failure. Mr. Scheuer's questioning of Mr. Charles Locke, Chairman of the Board of Morton Thiokol, showed that Thiokol is not prepared to accept the full contractual penalties for the Challenger accident.<sup>219</sup>

Finally, it is revealing that, under its NASA contract, Thiokol was never penalized for any of the numerous SRB flight anomalies.<sup>220</sup> The booster joint had never worked as intended, nor was its behavior at ignition ever clearly understood. Occurrences of O-ring erosion and/or blow-by exceeded twenty-five at the time of the Challenger accident. In fact, the *rate* of erosion/blow-by had increased steadily since the beginning of the SRB contract in 1983. The seal problem was serious enough to lead both to briefings at Headquarters and to establishment of a re-design task force. Yet, in spite of all these problems, Thiokol was eligible to receive a near-maximum incentive fee of approximately \$75 million. But, in the final analysis, it was NASA that both approved the SRB design

<sup>218</sup> NASA, Schedule D, NAS8-30490, April 12, 1983, p. 71.

<sup>219</sup> Cmte Hgs, Transcript, June 17, 1986, pp. 55-56.

<sup>220</sup> While this discussion focuses on possible contract penalties related to flight anomalies, it is also interesting to note that Thiokol has never been penalized for numerous safety and process violations at its Utah facilities. Several of these violations have resulted in serious fires and/or explosions.

and drew up an SRB contract which contained no provisions for performance penalties or flight-anomaly penalties. One must not fault Thiokol for collecting the bonus; one must fault NASA for allowing the bonus to be collected at all.

The problem with the kinds of penalties that were contained in the SRB contract is that, so long as management is convinced that a festering problem like the seal problem is not likely to cause mission failure, there is little incentive for the company to spend resources to fix the problem. In fact, if the solution involves significant delays in delivery, there may be a strong financial disincentive for the company to pursue a short-term solution aggressively. For example, Thiokol engineer R.M. Boisjoly provided a clear warning of the seriousness of the O-ring problem in July, 1985, and Thiokol engineer A. R. Thompson laid out a plan for a possible short-term solution to the problem.<sup>221</sup> Whatever its efficacy, why was Thompson's plan apparently dismissed so summarily? Part of the answer may be found in the June 18, 1986, exchange between Mr. Scheuer and Mr. Thompson:

Mr. SCHEUER. Would the research and development of your fixes have delayed the delivery of the SRMs to NASA?

Mr. THOMPSON. . . . It probably would have delayed it a month or two, at least for the hardware and some of the research work. . . .<sup>222</sup>

The Committee is certainly not suggesting that anyone in NASA or Thiokol would recommend launch or would refuse to spend resources fixing a problem if it was known that the problem constituted a real threat to mission safety. However, in the case of the SRB joint, both NASA and Thiokol managers clearly misjudged the threat to mission safety. In situations of this sort, contractual provisions rewarding performance rather than cost and schedule would have provided a far stronger incentive to fix a long-festering problem. Ultimately, the balance between safety incentives and cost/schedule incentives in the SRB contract may illuminate a number of issues raised by the Challenger accident.

---

<sup>221</sup> Rogers Commission Report, Volume I, pp. 249-51.

<sup>222</sup> Cmte Hgs, Transcript, June 18, 1986, p. 18.

## VII. CASING JOINT DESIGN

### *Discussion*

#### (a) Introduction

The fact that the aft field joint of the right-hand Solid Rocket Booster failed at the 300 degree location is overwhelmingly supported by the evidence. Retrieval of two large pieces of the joint clearly show that they were destroyed by the heat and velocity of the gas flame emanating from the right-hand booster. Additional supporting evidence was found by reviewing the telemetry data and the photographs taken during launch and flight.<sup>1</sup>

For the purpose of redesigning the joint it is important that the way in which the joint failed be determined as closely as possible. This determination, however, is difficult, if not impossible, to make with one hundred percent certainty. The evidence to support progress of the failure through the joint is incomplete. However, based on the recorded history of the joint problems encountered in flight and in test, based on the laws of physics, and based on behavior of the materials used in the joint, the following PROBABLE CAUSE is offered.

#### (b) Probable Cause of Failure

1. Both the primary O-ring and the secondary O-ring were seated when the steel casings were mated. The pressure check verified this fact. However, from experience, the primary O-ring was seated in the upstream position as had been previously recognized by NASA and Thiokol engineers. (See Figure VII-1.)

---

<sup>1</sup> Rogers Commission Report, Volume I, pp. 22-23 and 78-79.

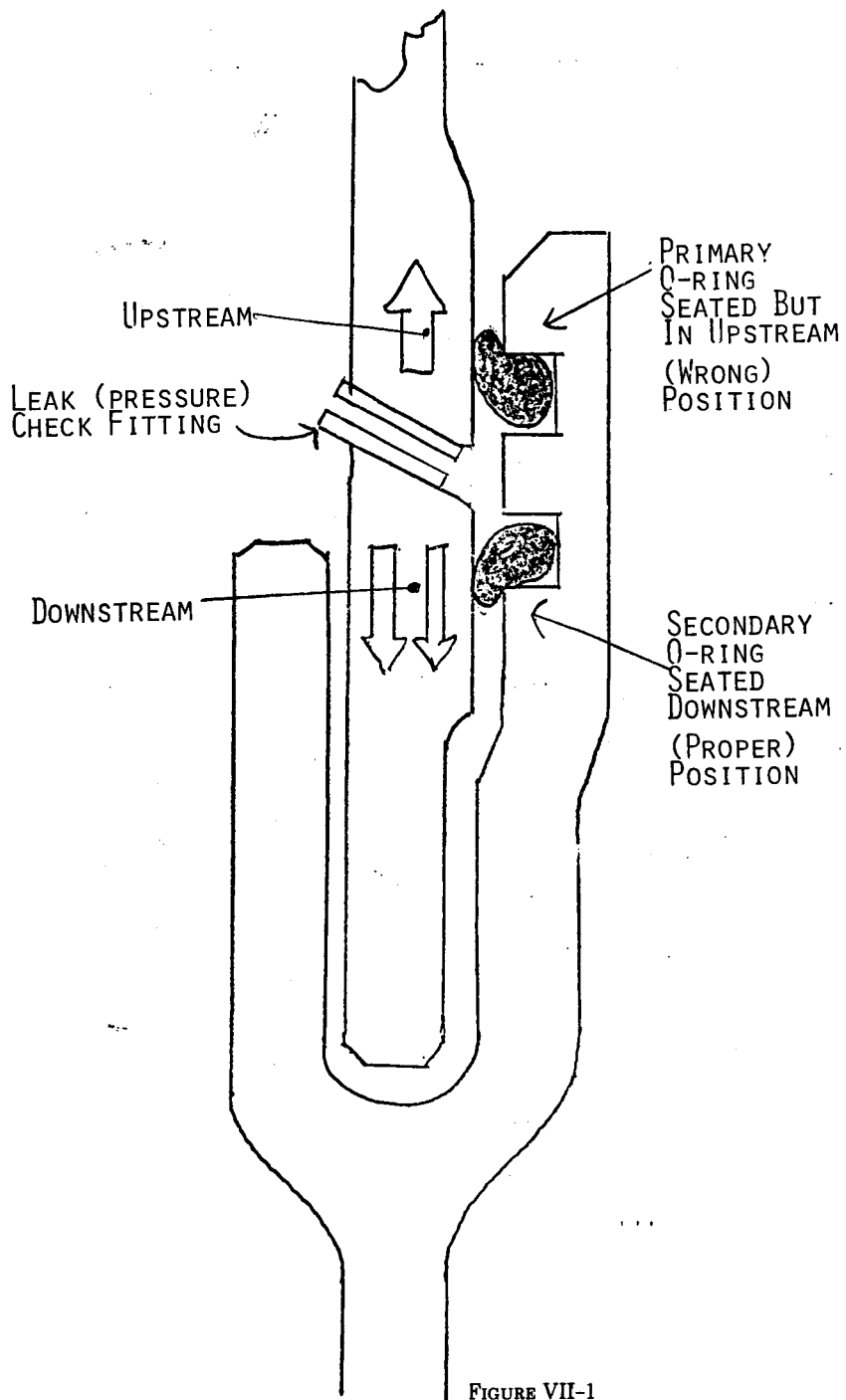

FIGURE VII-1



2. Upon ignition, the primary O-ring could not reseal at the 300 degree location in the downstream position, where it needed to be in time to prevent blowby. At this point there were too many deficiencies acting in unison which prevented the O-ring from reseating in that location. First, proper spacing between the inner face of the tang and the opposing face of the inner leg of the clevis approximately 0.020 inches, is critical. That spacing for Flight 51-L was too small, at the 300 degree location where the smoke was observed, to facilitate prompt reseating of the primary O-ring. Calculations of segment diameters indicate the gap spacing was only 0.004 inches, near metal-to-metal contact. The ignition gases passed the O-ring at this location (See Figure VII-2). This condition did not exist elsewhere in the joint around the casings since the primary O-ring was able to seat around the joint in other locations.

Second, the low temperature throughout the night prior to launch left the fluorocarbon elastomer primary O-ring stiff and lacking in ability to spring into the downstream (seated) position at the 300 degree location in time, relative to the buildup of motor pressure, to provide a tight seal. The temperature of the aft field joint at time of launch was calculated by Thiokol after the accident to be 16 degree F. Part of the reason for this low temperature was the heat transfer away from the joint, by conduction through the aft attachment strut. The conduction was driven by liquid hydrogen, which remained in the external tank overnight. The supercold fuel created a 430 degree temperature differential across the ship, drawing heat out of the joint and O-rings.

At ignition, blowby occurred, either with erosion of the primary O-ring or without erosion.

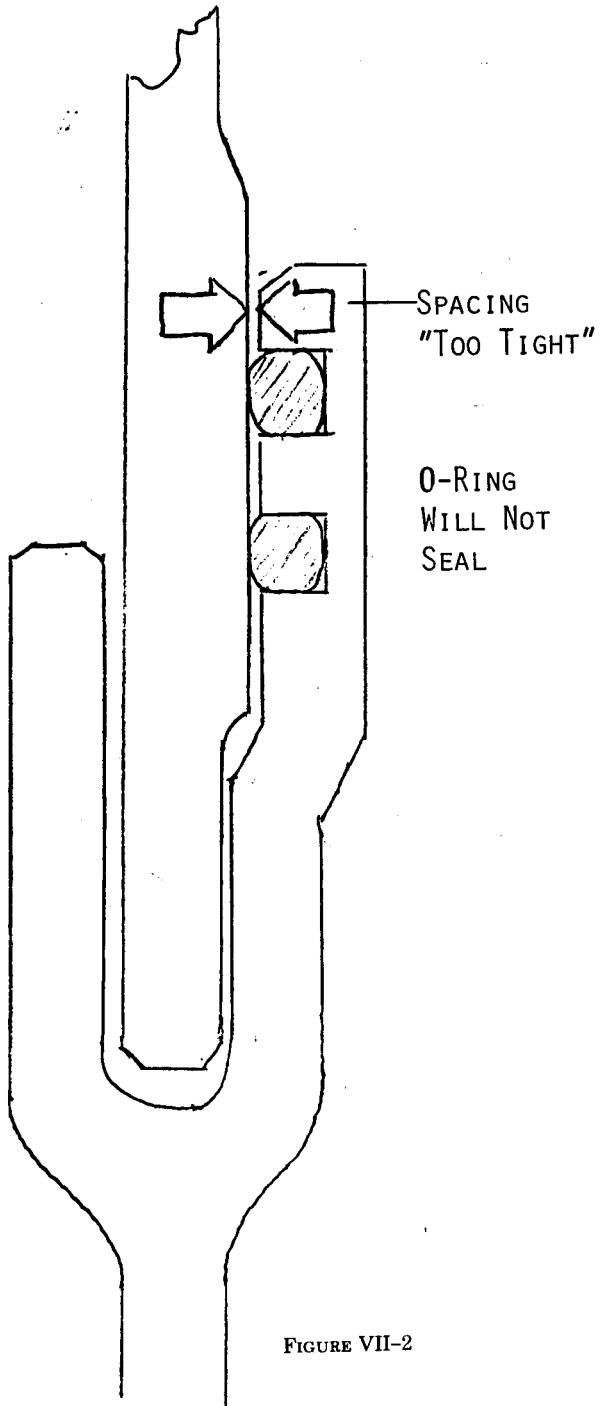

3. However, there could have been one or more than one blowhole through the zinc chromate putty before ignition. One such blowhole could have been made at the 300 degree location either during the leak check at 200 psi prior to the seating of the primary O-ring or prior to the leak check when the casings were brought together. If so, there was a high probability that the primary O-ring eroded at this point. The phenomena of blowing holes in the putty had been observed many times at post-flight dismantlement and had dramatically increased when the procedures were changed to increase the test pressure to 200 psi. Additionally, the Randolph putty had been found unsatisfactory on numerous occasions.<sup>2</sup>

4. Upon ignition of the Solid Rocket Motor, this blowhole would have facilitated and concentrated the hot propellant gas flame on the primary O-ring, and possibly the secondary O-ring as well. Alignment of O-ring erosion with the location of blowholes had been observed on numerous occasions.<sup>3</sup>

5. Between the time the casings were assembled and the launch, the secondary O-ring was unseated from its previously sealed position. The fact that it had been sealed has been verified by the pressure check made 28 days before when the casings were joined. Either the secondary O-ring was unseated by joint rotation coupled with O-ring stiffness or by the formation of ice in the joint.

During the intervening period, as the Shuttle stood on Pad 39B waiting for the launch, 7 inches of rain had fallen and some could have easily penetrated the joints. The access of rain water into the joints was proved when STS-9 was disassembled and water poured out of the assembly pin holes. In tests conducted after the accident, it was confirmed that the water in the aft field joint would have turned to ice, and that the ice could have dislodged the secondary O-ring, pushing it upstream into a non-sealed position. In this position, it is doubtful that the secondary O-ring could have sealed at ignition.

6. One of the three Solid Rocket Booster to External Tank aft attachment struts is also connected at the 300 degree location, just a few inches below the aft field joint. As the Space Shuttle system stood on the launch platform at Pad B on January 28, the large External Tank was gradually filled with liquid hydrogen and liquid oxygen. Liquid hydrogen, at a temperature of 423 deg F below zero, and liquid oxygen, at a temperature of 297 deg F below zero, caused the tank to contract as it was filled. Since the Solid Rocket Boosters are firmly bolted to the launch platform, a lateral force of approximately 190,000 pounds pulled sideways on the aft attachment strut and the Solid Rocket Motor casing, including the joint that failed.<sup>4</sup> Refueling of the tank was accomplished early on the morning of January 28.

At ignition, the 190,000-pound force was instantly released when the SRB hold-down bolts were blown loose. For the next two and a half seconds the right Solid Rocket Motor field joints experienced a 3 cycle per second vibratory load caused by the sudden release of

<sup>2</sup> NASA, MSFC Memo, Miller to Horton, April 12, 1984.

<sup>3</sup> Thiokol, "Erosion of SRM Pressure Seals," TWR 15160, Chart A-9, August 19, 1985: "Seal damage always has associated putty blowhole."

<sup>4</sup> NASA, MSFC, "51-L Analysis Overview," April 25, 1986, p. H-203.

the lateral force.<sup>5</sup> The ignition pressure increased the joint spacing. Also, the flow of motor gases through the blowhole at the 300 degree location could have resulted in damage to the primary O-ring. The evidence of smoke at the 300 degree location is unlikely without O-ring damage.

7. Smoke at launch, clearly visible in the photographs, stopped at 2.7 seconds when the vibratory load damped out and the joint sealed. The sealing of the breach at the 300 degree location was made possible by blockage from burned material, probably consisting of a mixture of insulation and aluminum oxide. Post-accident tests performed by Morton Thiokol proved that aluminum oxide could have successfully plugged the joint at 2.7 seconds. While the smoke at ignition appeared to be intermittent, that appearance was probably a result of air and main engine exhaust currents.

8. At T+37 seconds into the flight, the Shuttle encountered wind gust loads in conjunction with planned maneuvers. Components of these gust and maneuvering loads were transmitted to the Solid Rocket Booster through the External Tank attachment strut. Based on the presence of smoke at liftoff, these forces were transmitted to a joint already weakened by erosion and heat damage.

9. At 43 seconds into the flight, the main engines throttled back as the Shuttle reached "Max q" (maximum dynamic pressure). Four seconds later, the main engines had throttled up to 104% power and the geometry of the Solid Rocket Motor propellants had increased thrust. At this point, the motor pressure increased to 609 psi.

Additional structural loads resulted from turbulence. Flight 51-L experienced the most severe turbulence of any Shuttle flight and, although the loads were within the allowable design limits, those design limits did not consider a joint that had already failed.<sup>6</sup> It is unknown how much the combined effect of wind gust loads, maneuvering loads and an increase in thrust contributed to the accident. But the combined effects of these forces could have dislodged the burned material at the previously breached section of the joint.

10. Shortly after the vehicle was loaded by these turbulent forces, at T+58 seconds, a flame appeared from the same general region where the puffs of smoke had been seen. But, this time the joint was continuously breached by the burning propellant gases. In a little over two seconds, the flame had grown and acted as a blowtorch to burn through the hydrogen tank. The appearance of the flame at this time is also indicative of a damaged primary O-ring and failure of the secondary O-ring to seal, for reasons explained in the Critical Items List dated December 17, 1982.<sup>6a</sup>

The telemetry data, photographs and cockpit voice recordings support evidence of turbulent conditions and the manner in which the Shuttle failed.

---

<sup>5</sup> The joint was designed to accommodate these loads.

<sup>6</sup> NASA, MSFC, "51-L Analysis Overview, STS 51-L—Wind Shears, April 25, 1986, p. H-597.

<sup>6a</sup> NASA, "SRB Critical Items List," December 17, 1982, page A-6A, sheet 1.

Time (min:sec)	Crew position <sup>7</sup>	Crew comment
T+19	PLT	Looks like we've got a lotta wind here today.
T+20	CDR	Yeah.
T+22	CDR	It's a little hard to see out my window here.
T+28	PLT	There's ten thousand feet and Mach point five.
T+30		(Garble)
T+35	CDR	Point nine.
T+37		[High thrust vector control (steering) activity noted. This was caused by upper atmosphere wind gusts and planned maneuvers.]
T+40	PLT	There's Mach one.
T+41	CDR	Going through nineteen thousand.
T+43	CDR	OK, we're throttling down.
T+57	CDR	Throttling up.
T+58	PLT	Throttle up.
T+58		[Vehicle loaded by dynamic pressures.]
T+58		[A flame appeared from same general region where the puffs of smoke had been seen earlier.]
T+59	CDR	Roger.
T+60	PLT	Woooooohooo.
T+60		[Right SRM internal pressure began to diverge from that of left SRM]
T+61		[Well-defined plume was deflected indicating the plume had burned through the liquid hydrogen tank structure.]
T+62	PLT	Thirty-five thousand going through one point five.
T+64.7		[Liquid hydrogen leak noted.]
T+66.8	CDR	Reading four eighty six on mine.
66.800		[Leak confirmed when hydrogen tank leak pressurization system was unable to maintain normal pressurization rate.]
T+67	PLT	Yep, that's what I've got, too.
T+70	CDR	Roger, go at throttle up.
T+72.2		[Right Solid Rocket Booster motion differed from Orbiter and left Solid Rocket Booster, indicating failure of lower attachment structure.]
T+72.6		[Liquid hydrogen tank pressure fell. Leak was growing rapidly.]
T+73		[Liquid hydrogen and liquid oxygen pressure to main engines showed significant drop.]
T+73	PLT	Uh Oh
T+73.1		[Circumferential white pattern around the External Tank aft bulkhead suggested liquid hydrogen tank structure failure.]
T+73.1		[Vapor observed at inter-tank which was indicative of the liquid oxygen tank failing. Liquid oxygen then observed.] <sup>8</sup>

<sup>7</sup> (CDR) Commander Scobee, (PLT) Pilot Smith, (MS 1) Mission Specialist Onizuka, (MS 2) Mission Specialist Resnik.

<sup>8</sup> NASA, D.M. Germany, STS 51L Incident Investigation, Integrated Events Time Line, Johnson Space Flight Center, June 4, 1986, as modified.

### (c) Problems Discovered

The design of the joint was based on the successful design of the joints used on the Titan III booster rocket.<sup>9</sup> That design was similar except that the tang pointed upward, instead of down, and the clevis pointed downward, instead of up, as in the case of the Shuttle booster. Another difference was that the design of the Shuttle joint included two O-rings instead of one as provided for in the

<sup>9</sup> NASA, "SRB Critical Items List," December 17, 1982, p. A-6A, Sheet 1.

Titan design. But, the most important difference was the use of putty in the Shuttle design. While the Titan employed the NBR insulation to close the gap between segments, the Shuttle design called for filling a gap between insulation with putty.

The Shuttle design was changed to accommodate manufacturing constraints.<sup>10</sup> The Shuttle booster is larger, 146 inches in diameter as compared to 120 inches for the Titan. As a result of its larger size, the Shuttle booster uses more steel. While this requirement for more steel had no impact on other booster components, it did have an impact on the joint design. The maximum billet size (a piece of metal made from an ingot) commercially available to manufacture the large, one-piece, weld free forward dome with an integral forward skirt tang was less than that needed for the Shuttle Solid Rocket Boosters. However, it was found that by turning the casings upside down, there would be just enough metal to manufacture a forward dome because that component would then only have to incorporate the single joint element, the tang, instead of the double joint element, the clevis.

It is good engineering practice to design products to accommodate manufacturing tooling capabilities and methods. Furthermore, with the clevis facing up and the tang down, field assembly at the Kennedy Space Center was simplified. Combined with the extra O-ring, the design change appeared reasonable. But it is also good engineering practice to accommodate all the forces and conditions that the product must perform under during its useful life. The design of the Shuttle Solid Rocket Motor, as opposed to the Titan, had to provide for reuse of the propellant casings, including the wearing of joint surfaces and distortion of the case in handling and shipment. It had to accommodate heavier propellant loads. The design was more susceptible to water entry during storms. And, most significant, the design had to accommodate a combination of dynamic structural loads significantly different than those encountered by the Titan.

It is always a simple task to find fault with someone else's work; especially after an accident occurs. It is quite another matter to originate the work and produce a useful product.

The joint design provided a direct path between the combustion chamber, consisting of an annulus with propellant surrounding it, and the outside of the steel motor casings. That path was sealed with putty and two circular fluorocarbon elastomer (rubber-like) bands called O-rings. While O-rings are frequently used to retain pressures much higher than those present in the Shuttle Solid Rocket Motor, thermal and structural forces acting on the Shuttle joints are formidable. These joints must carry and transfer these loads between the casings.

Another essential ingredient of good engineering practice is to use material suited to the function. Some O-rings can withstand high temperatures. But "all . . . elastomers become brittle at low [temperatures]. . . Elastomers, like natural rubber, nitrile rubber, and Viton A . . . that become brittle at low [temperature]

<sup>10</sup> Staff discussion with E.G. Dorsey, Thiokol Wasatch Operations, Brigham City, Utah, September 4, 1986.

can be used for static seal gaskets when highly compressed at room temperature prior to cooling.”<sup>11</sup>

But the Shuttle's O-rings were not used in a “static” system as evidenced by the variations in gap spacing between the tang and clevis. Nor would they always be highly compressed at room temperature prior to the cooling. Furthermore, the O-rings could not withstand burning propellant temperatures in the range of 5800° F. The design of the joint therefore provided for putty to insulate the O-rings from the burning gases.

This putty did not always perform as had been expected, and evidence of hot gas passing the putty and getting to the first, or primary, O-ring along the path to the outside of the rocket chamber was discovered. Once the putty was breached, the joint was not working as it had been designed. This failure, although recognized by NASA and its contractor Morton Thiokol, was neglected on March 8, 1984 when they chose to accept an “allowable degree of erosion,” which meant there was an allowable percentage of failure.<sup>12</sup>

O-rings become effective (are seated) when pressure is applied to them as they sit in a groove provided to house them.

One question that the design was intended to answer was whether or not the O-ring was seated properly in its groove. An opening, with a fitting much like a valve stem on a tire, was provided to allow pressure testing between two such O-rings, the primary and the secondary.

But this design did not always answer the question: was the primary O-ring seated? Did it seal or not? Notice how the primary O-ring in Figure VII-1 (p. 176) is forced upward (shown by the single arrow). That is opposite to the normal direction that the propellant pressure acts (notice the double arrows). Even with an acceptable pressure check result, the primary O-ring would still be unseated for a fraction of a second when the motor pressure pushed the O-ring in the opposite direction from that which took place during the leak check.

The second reason the assumption concerning the leak check as “proof of sealing” could be erroneous was that the primary O-ring did not really have to seat at all if the putty behind it (toward the inside of the case) held the pressure during the leak check. So earlier in the program there really was no way to know whether the primary O-ring seated or not.

What appeared to be a rather straightforward joint was far from simple. If the primary O-ring did not seat during the leak check, and the pressure test succeeded, then the putty was doing the work of sealing. But it still was not possible to determine from outside the casings whether the putty or the O-ring was holding the pressure. But, if the leak check failed, then the O-ring was not seated and there was a blow-hole through the putty.

To resolve this concern, NASA and its contractor, Morton Thiokol, changed the leak-check procedure by increasing the pressure until a pressure of 200 pounds per square inch (psi) was accepted as

<sup>11</sup> Theodore Baumeister, Editor, *Standard Handbook for Mechanical Engineers*, 7th Ed., (New York: McGraw-Hill, 1967), pp. 18-35.

<sup>12</sup> Rogers Commission Report, Volume II, p. H-1.

the standard. They had ascertained that this was sufficient pressure to blow a hole through the putty.<sup>13</sup> Then, if the O-ring failed to seat, the pressure would blow a hole through the putty and the test would disclose an unseated O-ring (a failed seal). But if the O-ring held the higher pressure, the O-ring would still have been seated in the upper position instead of the downward position. That would be contrary to the way the O-ring would have to be seated to contain the propellant pressure during launch of the Shuttle.

In summary, there was still no way to verify whether the primary O-ring was seated properly, meaning in the downstream position after the cases were joined together in the field. In the beginning of the development program the concept was that the putty would act somewhat like a "piston in a cylinder" when the propellant was ignited. As the chamber pressure built up, the putty was to move downstream and compress the air in the path between it and the primary O-ring. The compressed gas was to seat the O-ring and thereby seal the joint. Besides, even if the primary O-ring didn't seal, surely the secondary O-ring would, since it had already been pressure checked, which verified it was seated in the downstream position.

There was no direct evidence that the primary O-ring was not holding the pressure off the secondary ring until Flight 51-B. That was the first flight when erosion of the secondary O-ring had been observed, even though erosion of the primary O-ring had occurred before.<sup>14</sup>

Thiokol had considered the joint design to be Criticality 1R,<sup>15</sup> meaning that there was redundancy. While the second O-ring was redundant by design, the joint as a whole was still Criticality 1, since if it failed, it would mean the loss of the Shuttle and crew. In other words, there was no backup for the joint.

The joint was designed to mate two rocket motor segment cases, one to the other, where the lower edge of the upper case consisted of a tang and the upper edge of the lower case consisted of a clevis. After the tang was inserted into the clevis (which housed the two O-rings), 177 steel pins, each approximately 1 inch in diameter, were inserted from the outside through aligned holes which went through the outer leg of the clevis, the tang and partly into the inner leg of the clevis. The spacing between the inner face of the tang and the mating face of the inner leg of the clevis where the O-rings were housed was critical to the integrity of the joint because that spacing, in part, determined whether the O-rings could function properly to seal against the propellant gas pressures. Not only was the initial static spacing critical, but maintaining the proper spacing during launch and flight under dynamic structural loadings was necessary for an effective seal.

Upon ignition of the Solid Rocket Motor fuel the operating pressure increases to 922 psi at 40 degrees F within a little over one-half second (0.648 sec).<sup>16</sup> The effect of this pressure increase is to

<sup>13</sup> NASA, MSFC, Problem Assessment System Record No. A07934, January 23, 1986, p. 6.

<sup>14</sup> Rogers Commission Report, Volume V, p. 1510.

<sup>15</sup> Cmte Hgs, Transcript, June 18, 1986, p. 51.

<sup>16</sup> Morton Thiokol, TWR-10212 (CD), Table 4-9, *Typical Propellant Design Data*.



cause the casings to bulge out around their midsections while being constrained by the thicker steel sections at the ends, much like a can of soda after freezing. The casings change shape during the buildup of motor pressure. This bulging has an effect on the joint. As in the case of the frozen soda can, the wall of the casing near the joint is no longer vertical, or perpendicular to the bottom, but angles out to meet the larger diameter in the center of the casing. NASA calls this change in angle at the joint "joint rotation."

This joint rotation is a component of an overall spacing problem that includes: changes caused by casing wear and tear experienced during refurbishment; case growth (swelling) from pressurizing the casings; distortion that occurs during shipment of the loaded casings; and the physical handling of the casings during stacking operations.

The joint rotation problem was aggravated when the steel casings were made thinner to achieve a reduction in weight and thus an increase in payload. The rotation problem was further aggravated by changing the design of the propellant geometry to achieve greater thrust. This increased the pressure within the casings and thereby increased the "gap opening."<sup>17</sup> These changes compromised the integrity of the joint seals because joint rotation increases the spacing (gap) between the tang and the O-ring grooves in the clevis.

When the increase in the gap occurs, it can open the O-ring seal, leaving the path from the propellant combustion chamber open to the outside of the casing, except for any blockage by the putty. But, as noted above, the putty frequently has holes blown through it. If there were blowholes in the putty, and the original spacing between the metal parts of the joint was such that the joint rotation left open spaces between the O-rings and the tang, then the joint would fail and burning gases would escape to the outside.

#### (d) Joint Behavior

In a memo from John Miller to Mr. Eudy of NASA on June 16, 1980, the following statement was made:

STA-1 test data shows that the secondary O-ring can become unseated from the tang due to joint rotation at approximately 40 percent of MEOP [Mean Effective Operating Pressure], and therefore, is not likely to assume a sealing position should the above primary seal failure occur. The SRM has never been tested to evaluate the above failure condition, nor has credibility of such a failure been officially declared.<sup>18</sup>

In March of 1984 Thiokol had completed its SRM O-ring assembly test plan, which was to confirm the O-ring erosion scenario, provide data for heat transfer predictions and establish the effec-

<sup>17</sup> The Light Weight Casings, first used on STS-6, had thinner casing walls than the standard steel casings. Light weight casings permitted flight with heavier payloads. On STS-8, NASA began using the High Performance Motor (HPM) which developed higher internal pressures while using the light weight casings. The purpose of the HPM was to further increase payload capacity.

<sup>18</sup> NASA, "Evaluation of TWR-12690 CD, Test Plan for Space Shuttle SRM Lightweight Cylinder Segment Joint Verification, dated June 10, 1980", EP 25 (80-70), June 16, 1980, p. 2.

tiveness of the vacuum putty. The introduction to that plan included the statement:

O-ring seals in rocket motors in general and the Space Shuttle SRMs in particular, can suffer thermal degradation because of exposure to the high temperature motor chamber gases. Although none of the SRM primary O-rings to date have failed to perform their design function, there is some concern because of isolated events which show localized erosion as high as 0.053 inches. The postulated scenario for this thermal degradation effect is a short-time duration impingement of a high energy jet which is induced during ignition pressurization by a combination of voids in the protective vacuum putty and the filling of available free volumes created by the tolerances of mating parts and the O-ring slots. Unfortunately, the overall assembly and the vacuum putty layup does not lend itself to a well-defined geometry for predicting the hot gas flow and associated heat transfer to the O-rings.<sup>19</sup>

A subsequent report, dated May 7, 1984, contained a statement:

Symptom of failure: a vacuum putty exhibited gas paths located at 319 deg., 338 deg., and 347 deg. Erosion of the primary O-ring occurred at 319 deg. only. The damaged region was approximately 5.6 inches long with a .034 inch maximum depth and involved 136 deg. of the O-ring cross section diameter.<sup>20</sup>

In a memo from Larry Mulloy to Bob Lindstrom, Director, MSFC Shuttle Projects Office, in November of 1984 it was noted:

. . . it was determined that shims could be used to make the case joint sufficiently concentric to consistently achieve a 7.54 percent minimum O-ring squeeze. Therefore the 7.54 percent has been established as the minimum acceptable requirement for both case and nozzle O-ring joints and verified by subscale testing and full scale experience.<sup>21</sup>

On a 0.280 inch diameter O-ring a 7.54 percent squeeze would be equal to a compression distance of 0.021 inches.<sup>22</sup>

On July 17, 1985, Irv Davids, Manager of the Solid Rocket Booster Program at NASA Headquarters, sent a memo to the Associate Administrator for Space Flight, the subject of which was case-to-

<sup>19</sup> Thiokol, Philip Shadlesky, "Performance Characteristics of the SRM O-ring Assembly Test Plan", TWR-14336, dated March 1984, p. 1.

<sup>20</sup> Thiokol, S. Rodgers, "Significant Problem Report DR4-5/35: 5 Day Report; O-ring Erosion at Nozzle/Aft Segment Joint of SRM 11A (STS 41-B/Mission 41-C)", TWR-14370-1, May 7, 1984, pp. 1-2.

<sup>21</sup> O-ring squeeze is the distance, in fractions of an inch, that an O-ring is compressed from its normally round shape. This dimension can also be expressed as a percentage of the total diameter before compression. In 1984 NASA was using a term "minimum O-ring squeeze." During an SRM design analysis of the case and nozzle O-ring joints it was concluded that the 146 inch diameter case cylinders would not meet the design standard of 15 percent minimum O-ring squeeze at zero pressure. The various problems that prevented this included flaws in the O-ring grooves and sealing surfaces and differences in the spacing between tang and clevis on various casings.

<sup>22</sup> NASA, Larry Mulloy, "ECP SRM 1197, Nozzle Nose Inlet Housing O-ring Squeeze," SA 42-562-84, November 20, 1984, p. 1.

case and nozzle-to-case O-ring seal erosion problems.<sup>23</sup> Davids sent copies to Messrs. Weeks, Hamby, Herrington and Winterhalter.<sup>23a</sup> In the memo it was noted that there has been twelve instances of primary O-ring erosion during Shuttle flights. In addition, in one specific case there had also been erosion of the secondary O-ring seal. There were also two primary O-ring seals that were heat affected without erosion and two cases in which soot blewby the primary seals. In this memo it was noted that the prime suspect for the cause of erosion on the primary O-ring seals was the type of putty being used. It was Thiokol's position that during assembly leak check, or ignition, a hole could be formed through the putty which then initiated O-ring erosion due to a "jetting effect." It was even mentioned in this memo that Thiokol was seriously considering the deletion of putty on the QM-5 nozzle/case joint since they believed the putty was the prime cause of the erosion. Davids, however, had reservations about deleting the putty because he recognized the significance of the QM-5 firing in qualifying the FWC (Filament Wound Case) for flight.

In the matter of case-to-case O-ring erosion the memo noted that there had been five occurrences during flight where there was primary field joint O-ring erosion. There was also one case where the secondary O-ring was heat damaged with no erosion. The memo stated:

The erosion with the field joint primary O-ring is considered by some to be more critical than the nozzle joint due to the fact that during the pressure build up on the primary O-ring the unpressurized field joint secondary seal unseats due to joint rotation.<sup>24</sup>

The memo continued:

The problem with the unseating of the secondary O-ring during joint rotation has been known for quite some time. In order to eliminate this problem on the FWC field joints a capture feature was designed which prevents the secondary seal from lifting off.<sup>25</sup>

Lastly the memo noted:

The present consensus is that if the primary O-ring seats during ignition, and subsequently fails, the unseated secondary O-ring will not serve its intended purpose as a redundant seal. However, redundancy does exist during the ignition cycle, which is the most critical time.<sup>26</sup> (See Appendices VII-B and VII-C.)

On August 2, 1985, Larry Wear, MSFC's SRM Element Manager, sent a letter to Joseph Kilminster, Thiokol's Vice President for Space Booster Programs, on the subject of SRM field joint second-

<sup>23</sup> NASA, Irving Davids, "Case to Case and Nozzle to Case 'O' Ring Seal Erosion Problems," July 11, 1985.

<sup>23a</sup> Mr. Weeks, Dep. Assoc. Administrator for Space Flight (Technical); Mr. Hamby, Dep. Dir., STS Program Integration; Mr. Herrington, Dep. Dir. of Launch & Landing Operations; and Mr. Winterhalter, Acting Dir., Shuttle Propulsion Div.

<sup>24</sup> *Ibid.*, p. 2.

<sup>25</sup> *Ibid.*

<sup>26</sup> *Ibid.*

ary O-ring lift-off during pressurization. The letter concerned the situation wherein one O-ring might not seal subsequent to joint rotation. The letter stated:

Because of recent experiences of flight and ground test motors having increasing incidences of putty blow-holes and the associated burning of primary O-ring, it would seem prudent for us to attempt to assure that the secondary O-ring is capable of sealing during the entire SRM burn.<sup>27</sup>

The letter requested an assessment of the possibility of lift-off of the secondary O-ring.

In August of 1985 Jim Thomas, MSFC's Deputy SRM Element Manager, wrote a memo for Mr. Mulloy to Mr. Hamby at NASA Headquarters, which was apparently never signed or sent. The subject of the memo was SRM Joint/O-ring Erosion. The memo stated:

On July 11, 1985, you and Irv Davids were briefed by Jim Thomas of my office on the history of the effort underway to resolve the issues and concerns of the above subject.

The memo then went on to discuss a number of questions.

1. What would happen if the secondary seal lifted off the mating surface during motor pressurization, and, also, how long it would take for the seal to return to a position where contact was made? The answer to that question stated that bench test data indicated that the O-ring resiliency, that is, its capability to fill the gap between the tang and the clevis, was a function of temperature and the rate at which the gap opened.

The memo stated, "at 100 deg. F the O-ring maintained contact. At 75 deg. F the O-ring lost contact for 2.4 seconds. At 50 deg. F the O-ring did not reestablish contact in 10 minutes at which time the test was terminated." The memo then stated, "the conclusion is that secondary sealing capability in the SRM field joint cannot be guaranteed."<sup>28</sup>

2. Another question concerned whether or not the secondary O-ring would seal in sufficient time to prevent joint leakage if the primary O-ring had not sealed. The answer to that question was as follows:

MTI has no reason to suspect that the primary seal would ever fail after pressure equilibrium is reached, i.e., after the ignition transient. If the primary O-ring were to fail from 0 to 170 milliseconds, there is a very high probability that the secondary O-ring would hold pressure since the case has not expanded appreciable at this point. If the primary seal were to fail from 170 to 330 milliseconds, the probability of the secondary seal holding is reduced. From 330 to 600 milliseconds the chance of the secondary seal

<sup>27</sup> NASA, Larry Wear, "SRM Field Joint Secondary O-ring Lift-Off During Pressurization," SA 41-326-85, August 2, 1985.

<sup>28</sup> Engineering consultants to the Committee have serious questions as to how this test relates to actual O-ring performance in flight hardware.

holding is small. This is direct result of the O-ring's slow response compared to the metal-case segments as the joint rotates.

3. The third question indicated that NASA Headquarters was not aware that the secondary O-ring may not seat due to joint rotation, and they wanted to know when this data was incorporated into the FMEA/CIL? The answer noted that Thiokol had submitted a TWR-13520 to MSFC in December of 1982. This was approved by NASA Level III on January 21, 1983. NASA Level II authorized a change request March 2, 1983 and Level II issued a PRCBD to implement approved Level I change request on May 2, 1983.<sup>29</sup>

Thiokol completed their engineering study of O-ring compression set and dated the report October 2, 1985.<sup>30</sup> (Compression set relates to the ability of a material, in this case, O-rings, to rebound to its original dimensions after having being subjected to compression for various periods of time and or at various temperatures.) That report contained the following information. There was a concern of the ability of the O-ring to rebound to or near its original dimensions after having been subjected to compression for various periods of time and at various temperatures. The Parker Seal Company of Culver City, California, tested several O-rings to determine the properties of the material. Two compression set tests in accordance with ASTM (American Society for Testing and Materials) D-395 method B were performed.<sup>31</sup> The first test was conducted at a constant temperature of 75 deg. and the time that the ring was in compression was varied. In the second test the temperature was varied and the compression was held constant. A small O-ring of 0.139 inch diameter was used for test purposes. The test showed that the percentage of compression increased with an increase of temperature. However, these tests were not conducted at low temperatures. Rather, they were conducted at temperatures of 212 deg. F and above and therefore, they have little relevance to ambient conditions.

A status report from Thiokol's SRM O-ring Task Force, presented on November 20, 1985, recommended that a slightly larger Viton O-ring of 0.292 inch diameter, along with thicker shims, be used as a short-term solution. The current O-rings were 0.280 inches. Thiokol pointed out that there would be more erosion margin due to greater material thickness at the sealing surface. They noted that the thicker shims would reduce the initial and absolute final gap opening dimension, resulting in more O-ring "squeeze" initially. Thiokol stated that the greater initial squeeze would be better for compression set and resiliency, and would give a higher probability of maintaining a secondary seal longer into the ignition transient. Thiokol also noted that various tests were conducted on the Randolph putty using hot five-inch char motors.<sup>32</sup> Two tests were conducted, which determined that the

---

<sup>29</sup> NASA, Larry Mulloy, "SRM Joint/O-ring Erosion," SA 42-349-85, August 1985, pp. 1-2.

<sup>30</sup> Thiokol, B.L. Orme, "Engineering Study of O-ring Compression Set," TWR-15218, October 2, 1985.

<sup>31</sup> Refer to Appendix VII-A for ASTM specification.

<sup>32</sup> Small scale test motors.

putty erosion could take place at a rate between 5.5 and 13.0 mils per second. Two other tests noted that the erosion on GS-43<sup>33</sup> putty was ten times higher than that on the Randolph.<sup>34</sup>

Primary concerns drawn from the charts provided by Thiokol on January 27, 1986, centered around the following items. During the ignition transient, 0 to 170 milliseconds, there is a high probability of a reliable secondary seal. Between 170 and 330 milliseconds there is a reduced probability of a reliable secondary seal and between 330 and 600 milliseconds there is a high probability of no secondary seal capability. Under steady state conditions, between 600 milliseconds and two minutes, the notes states "if erosion penetrates primary O-ring seal—high probability of no secondary seal capability."<sup>35</sup>

A. Bench testing showed O-ring not capable of maintaining contact with metal parts gap opening rate to MEOP.

B. Bench testing showed capability to maintain O-ring contact during initial phase (0 to 170 ms) of transient.<sup>36</sup>

What follows is taken from Chart 2-2:

1. A temperature lower than current data base results in changing primary O-ring sealing timing function.

2. SRM 15-A 80 deg. arc black grease between O-rings. SRM 15-B 110 deg. arc black grease between O-rings.

3. Lower O-ring squeeze due to lower temperature.

4. Higher O-ring Shore hardness.

5. Thicker grease viscosity.

6. Higher O-ring pressure activation time.

7. Activation time increases, threshold of secondary seal pressurization capability is approached.

8. If threshold is reached then secondary seal may not be capable of being pressurized.<sup>37</sup>

The presentation went on to included the following blow-by history:

SRM 15 worst blow-by.

A. Two case joints (80 deg.), (110 deg.) arc.

B. Much worse visually than SRM 22. SRM blow-by.<sup>38</sup>

The presentation then included a chart titled "O-ring (Viton) Shore Hardness vs. Temperature."<sup>39</sup>

Degree F	Shore Hardness
70 degrees	77 hardness
60 degrees	81 hardness
50 degrees	84 hardness
40 degrees	88 hardness
30 degrees	92 hardness
20 degrees	94 hardness
10 degrees	96 hardness

<sup>33</sup> A type of putty made by another company that also was considered for use in the SRM.

<sup>34</sup> Thiokol, "SRM O-ring Task Force Status and QM-5 Recommendations," TWR-15349, November 20, 1985.

<sup>35</sup> Thiokol, "Temperature Concern on SRM Joints," January 27, 1986, chart 2-1.

<sup>36</sup> Ibid.

<sup>37</sup> Ibid., Chart 2 2.

<sup>38</sup> Ibid., Chart 3-1.

<sup>39</sup> Ibid., Chart 4-1.

The term Shore Hardness refers to a method of identifying the hardness of materials, and a higher number means a harder material. Regardless, though, it is seen from the above table that the hardness increases as the temperature decreases. Engineers presented a chart titled Secondary O-ring Resiliency, listing the following temperatures.<sup>40</sup>

Temperature degree F	Time to recover (seconds)
50 degree	600 recover
75 degree	2.4 recover
100 degree	*did not separate

The conclusions presented at the end of the teleconference were:

1. Temperature of O-ring is not only parameter controlling blow-by. SRM 15 with blow-by at an O-ring temperature at 53 deg. F. SRM 22 with blow-by at an O-ring temperature at 75 deg. F. Four development motors with no blow-by were tested at O-ring temperature of 47 deg. to 52 deg. F. Development motors had putty packing which resulted in better performance.

2. At about 50 deg. F blow-by could be experienced in case joints.

3. Temperature for SRM 25 on 1/28/86 will be 29 deg. F 9:00 a.m., 32 deg. F. 2:00 p.m.

4. Have no data that would indicate SRM 25 is different than SRM 15 other than temperature.<sup>41</sup>

#### Recommendations

1. O-ring temperature must be greater than or equal to 53 deg. F at launch. Development motors at 47 deg. to 52 deg. F with putty packing had no blow-by. SRM 15 (the best simulation) worked at 53 deg. F.

2. Project ambient conditons (temperature and wind) to determine launch time.<sup>42</sup>

The effect of Thiokol's recommendations would be that the Shuttle should not be launched unless the O-ring seal temperature was at least 53°F.

#### (e) Loads Acting on the Joint

There are other loads on the joint in addition to those caused by the pressures of the burning propellant. The following table identifies those loads relative to time.<sup>43</sup>

Time	Activity	Source of load	Static or dynamic	Impact on joint
Days before launch.....	Mating of casing.....	Weight of upper casing contacting lower casing.	Static plus impact .....	Physical contact between tang and clevis.

<sup>40</sup> Ibid., Chart 4-2.

<sup>41</sup> Ibid., Chart "Conclusions."

<sup>42</sup> Ibid., Chart "Recommendations."

<sup>43</sup> This Chart was prepared by the Committee and is based on information obtained by Committee staff during meetings at MSFC on June 30, 1986.

Time	Activity	Source of load	Static or dynamic	Impact on joint
Days before launch .....	Solid rocket motor assembly (Stacking) at MSC.	Weight of SRB components.	Static.....	Compressive; shear on pins at faces between tang and each clevis leg.
Days before launch .....	Joining of the external tank, and orbiter to SRB's.	Additional weight of tank and orbiter.	Static.....	Compressive; additional shear on pins which connect tang to clevis.
Days before launch .....	Transport to pad on crawler.	Movement of Transporter...	Static and dynamic.....	Compressive; slight shear changes on pins.
Days before launch .....	Addition of payloads .....	Added weight.....	Static.....	Additional compressive and shear loads.
Within 24 hours of launch.	Loading of fuel .....	Weight of liquid hydrogen and liquid oxygen.	Static.....	Additional compressive and shear loads.
Within 24 hours of launch.	Loading of fuel .....	External tank contracts in diameter due to reduction in temperature.	Static.....	Lateral tensile force applied by aft attachment structure between external tank and solid rocket motor casing.
6 seconds to launch .....	Firing of main engines (SSME's).	Thrust of engines.....	Static and dynamic.....	Further moments compressive and vibratory (25 to 30 Hz).
At start of launch.....	Solid rocket motor ignition before lift-off.	Combustion pressures.....	Basically static.....	Bending (Joint rotation) lateral forces perpendicular to casing walls.
At start of launch.....	Solid rocket motor ignition before liftoff.	Engine thrust.....	Static and dynamic.....	Instant load reversal from compressive to tensile in joints and instant shear reversal in pins.
At start of launch.....	Release of hold down bolts.	Instant release of lateral force at aft External Tank attachment structure.	Dynamic.....	Instant change in stress, vibratory at 3 Hz.
At liftoff.....	Launch maneuvering.....	Thrust, plus nozzle vector forces.	Static and dynamic.....	Combination: Vibration, tensile, shear, lateral (via attachment structure).
Launch phase.....	In-flight maneuvering.....	Thrust plus gimbaling, applied loads at attachments.	Static and dynamic.....	Combination vibration, tensile, shear, lateral.
Launch phase.....	Turbulence—wind gust loads.	Impact, thrust nozzle gimbaling (changes in applied loads).	Static and dynamic.....	Impact loads transmitted to joints.
Launch phase.....	Reduction of main engine power and Solid Rocket Motor thrust at Max q (maximum dynamic pressure).	Decrease in thrust.....	Static and dynamic.....	Changes in bending and stress in joint, changes in frequency of vibration.
Launch phase.....	Increases in thrust thrust of main engines and solid rocket motors.	Increase in thrust.....	Static and dynamic.....	Changes in bending and stress in joint and in vibration.
Separation phase.....	Burning out of solid propellants and explosive forces at attachment points.	Release of thrust, impact forces at attachment points.	Static and dynamic.....	Reduction of tensile forces and shear on pins.



Time	Activity	Source of load	Static or dynamic	Impact on joint
Ocean impact and retrieval.	Weight of SRB impacting ocean at about 60 mph (vertical) 25 mph (horizontal).	Impact on joint .....	Dynamic .....	Variation in stresses at joints.

How these loads are accommodated by the joint is critical to the seal. In Thiokol's analytical evaluation report (TWR-12019, dated October 6, 1978), S. Stein of the Structures Section included the statement, "except in local area of pin, all stress levels are considerably below yield."<sup>43a</sup> As a result of this information, the Committee will explore this condition as part of its normal oversight work to determine the long-term effect on structural integrity of the casings.<sup>44</sup> Stein also wrote, "at MEOP [maximum expected operating pressure] the primary 'O' ring gap increases 0.052 and the secondary 0.038".<sup>45</sup> It should be noted however, the analysis was made for no thrust, i.e. internal pressure only.<sup>46</sup> As noted on the forgoing chart, loads on the joint do work in combination and so the analysis should also provide for the combined effect of all loads at the time they occur.

On page 55 of the Rogers Commission Report there is a chart which shows a series of curves which relate maximum aerodynamic force to Mach Number. As a result of a discussion with Dr. Richard Feynman, Department of Physics, California Institute of Technology, and a member of the Rogers Commission, the Committee will review these curves after the completion of this report in an effort to ascertain their validity. There is reason to suspect that the "flight envelope" as represented in the chart is inaccurate.<sup>47</sup>

As stated previously, the proper choice of materials is critical to attaining performance objectives. The steel casings are designed to withstand the propellant pressures and loads incurred in flight. Secondly, they must accommodate these forces over and over as the casings are reused. Consequently, the choices of the type of steel selected was important.

The steel used to make the casings and the joint is a D-6A. D-6A is a low-alloy steel for aircraft and missile structural applications. It is designed primarily for use at room-temperature tensile strengths of 260 to 290 ksi.<sup>48</sup> D-6A maintains a very high ratio of yield structure to tensile strength up to a tensile strength of 280 ksi, combined with good ductility.

Typical mechanical properties of D-6A steel: <sup>49</sup>

<sup>43a</sup> Thiokol, S. Stein, "Analytical Evaluation of the Space Shuttle Solid Rocket Motor Tang/Clevis Joint Behavior", TWR-12019, October 6, 1978, p. 1.

<sup>44</sup> Thiokol, S. Stein, "Analytical Evaluation of Space Shuttle SRM Tang/Clevis Joint Behavior", TWR-12019, October 6, 1978.

<sup>45</sup> Ibid.

<sup>46</sup> Ibid.

<sup>47</sup> Discussion with Dr. Richard Feynman, California Institute of Technology, Pasadena, California, September 3, 1986.

<sup>48</sup> 1000 pounds per square inch equals 1 ksi.

<sup>49</sup> American Society for Metals, Handbook Edited by H.E. Boyer and T.L. Gall, November, 1984.

Tempering temperature		Tensile strength ksi	Yield strength ksi	Elongation in 50 mm or 2 in., percent	Reduction in area, percent	V-notch impact energy ft.-lb
°C	°F					
150	300	299	211	8.5	19.0	10
205	400	290	235	8.9	25.7	11
315	600	267	247	8.1	30.0	12
425	800	236	228	9.6	36.8	12
540	1,000	210	204	13.0	45.5	19
650	1,200	150	141	18.4	60.8	30

Normalized at 990°C (1650°F) and tempered at various temperatures.

In addition to the steel, other principal materials in the joint design that were to seal in the propellant gases were the zinc chromate putty and the O-rings.

On April 12, 1984, John Miller, Chief of the Solid Motor Branch of NASA, wrote a memo to Mr. Horton, Chief Engineer, SRB Engineering Office, MSFC which referred to concerns with putty made by Randolph. The Randolph putty was selected on the basis that it had several desirable performance characteristics. The change in putty was made after Fuller-O'Brien discontinued making putty because their product contained asbestos. Mr. Miller noted, "Stacking difficulties and observed O-ring anomalies appear to be more frequent with Randolph putty than with the previously used Fuller-O'Brien putty."<sup>50</sup> Miller requested that Thiokol expedite development and qualification of a putty with properties similar to those of Fuller-O'Brien.

On June 18, 1984, Miller wrote Horton again, mentioning erosion/heat exposure O-ring experience on QM-4, STS-2, STS-6, STS-11, and STS-13 and citing Deficiency Reports which violated specifications.<sup>51</sup>

By June 29, 1984, 5 inch motor tests has been completed. These tests substantiated the concept of hot gas jet impingement against O-rings. Interestingly, a simulation of "no putty" yielded no O-ring damage. This information was conveyed to NASA via telecon from Thiokol, which also stated that there was no second source for the Randolph putty. Thiokol had abandoned their program to mix the putty themselves. Measures taken to correct the putty problems included changes in the putty layup to reduce air entrapment, use of a porous sacrificial heat barrier such as carborundum fiberfrax or removing the putty and reducing joint gaps were introduced.<sup>52</sup>

A new joint design was forwarded to NASA by Thiokol on July 19, 1984, which included a fill capture feature. This feature looked similar to the "capture feature" proposed for future Shuttle flights. The fill capture feature, however, was to be filled with grease. A thermal analysis had shown that "severe heat effects would result if the cavity were not filled."

As stated previously, the putty was to insulate the O-ring seals from the hot propellant gases. It was also to remain flexible enough to move outward under the pressure of the burning propellant, thereby compressing the gas in the joint which, in turn, was

<sup>50</sup> NASA, John Miller, "Concerns with Randolph Vacuum Putty," EP-25 (84-35), April 12, 1984.

<sup>51</sup> NASA, John Miller, "Zinc Chromate Putty Installation in Nozzle to Case Joint Discrepancy," EP-25 (84-53), June 18, 1984.

<sup>52</sup> Thiokol, "Vacuum Putty Telecon," June 29, 1984.

to seat the primary O-ring. O-rings require some pressure from the working fluid, in the case of the SRM, this was gas, in order to seat properly and provide a effective seal. In practice, this design philosophy did not prove to be correct because the putty frequently held the pressure off of the O-rings, or if it did not, the putty had blowholes in it. It was then postulated that these holes might actually benefit the seating of the O-ring by allowing more pressure to reach it sooner. It was even suggested that holes might be deliberately made through the putty. However, it was then learned that blowholes served to concentrate propellant gas on small segments of the primary O-ring and caused the ring to erode.

The unacceptable heat erosion damage to both primary and secondary O-rings on SRM-16A resulted in an evaluation of the putty produced by Randolph Products. In July 1985, L. Thompson of MSFC made a presentation which noted that five different types of putty from four companies were under study in an effort to solve the putty performance problem. As late as 1985 twelve different types of tests had been performed and six more were in progress. The only putty to survive the water tests was General Sealants No. 43, which was a non-asbestos formulation. The Randolph putty had disintegrated in all three water tests. However, in comparing dynamic viscosity to temperature, the General Sealants product, at 25,000 poise,<sup>53</sup> was not viscous above 125 deg C. It was slightly better than the Randolph product and another product made by Inmont. The previously used Fuller-O'Brien product, however, increased in dynamic viscosity with an increase in temperature. It was 100,000 poise at 250 deg C, while it was less than 50,000 at 50 deg C.<sup>54</sup> Consequently, no product met all the design requirements as well as the Fuller-O'Brien did.

The Randolph putty is hydroscopic and its behavior is unsuited to use in the dry climate of Utah, as well as the humid climate of the Florida coast. In one case the putty was too stiff and in the other, too sticky. Since both factory and field joints required the use of the putty, a product with consistent performance in both climates was required.

The materials used in the manufacture of the O-rings was also critical to the safe operation of the Shuttle system. The O-rings had to be serviceable at the high temperatures in the joint which would result from heat transfer from the rocket combustion chamber. However, the use of NBR insulation around the propellant, and the use of putty, was to protect the steel casings and the O-rings from the direct heat of the propellant gases. This protection was not always successful when blowholes in the putty occurred, however, and the O-rings would frequently be damaged by heat. The lower temperatures that occur in Florida during the winter months was not covered by NASA's specifications. While elastomers are known to become brittle at low temperatures, a product specification sheet on Viton Fluoroelastomer claimed, "Cold-VITON is generally serviceable in dynamic applications down to -18 to -23 deg C (0 to 10 deg F)."<sup>55</sup> The sheet added: "The brittle point of Viton at a thick-

---

<sup>53</sup> Poise is a measure of viscosity or resistance to flow.

<sup>54</sup> NASA, L.M. Thompson, "SRM/SRB Putty Evaluation," July, 1985.

<sup>55</sup> 3M-Chemical Division, "Viton Fluoroelastomer," Undated, p. 1.

ness of 0.075 inches is in the neighborhood of 50 deg F. Yet, as with other elastomers, thickness has a marked effect upon low temperature flexibility. Thinner cross-sections are more flexible than thicker ones at every temperature." The thickness of the O-rings on the Shuttle is 0.280 inches, thicker than the 0.075 inch article with a brittle point of 50 deg F noted above.<sup>56</sup> Consequently, the brittle point of Viton was misleading since the O-rings were much larger than the test specimen.

Military Specification MIL-R-83248A, 17 Feb. 84, "Rubber, Fluorocarbon Elastomer, High Temperature, Fluid, and Compression Set Resistant" set the specification for the O-rings that Thiokol had to meet.<sup>57</sup> They included:

Type I-O-rings and compression seals Class I-75 +/- 5 Hardness<sup>58</sup>

This specification then included other specifications issued by the Society of Automotive Engineers and the American Society for Testing Materials. One of the ASTM Specifications listed was ASTM 1329, "Evaluating Rubber Property, Retraction at Low Temperatures."<sup>59</sup> It was these referenced specifications which defined the significant characteristics required.

On February 6, 1979, Mr. William Ray of NASA's Marshall Space Flight Center, sent a memo to Messrs Hardy, Rice, Eudy, and McCool (See Appendix V-I). That memo was essentially a trip report of Mr. Ray's visits to the Precision Rubber Products Company and the Parker Seal Company, in search of information on the performance of O-rings. Some of the points covered in the memo were:

The purpose of the visits was to present the O-ring seal manufacturers with data concerning the large O-ring extrusion gaps being experienced on the Space Shuttle Solid Rocket Motor clevis joints and to seek opinions regarding the potential risks involved.<sup>60</sup>

With regard to the visit with company officials at Precision Rubber Products, "they voiced concern for the design, stating that the SRM O-ring extrusion gap was larger than that covered by their experience."<sup>61</sup>

In response to the data presented to Parker Seal Company officials by Mr. Ray, Parker officials "also expressed surprise that the seal had performed so well in the present application."<sup>62</sup>

Regarding the visit with the Parker officials, the memo stated, "their first thought was the O-ring was being asked to perform beyond its intended design and that a different type of seal should be considered."<sup>63</sup>

<sup>56</sup> Ibid.

<sup>57</sup> Department of Defense, "Military Specification: Rubber, Fluorocarbon Elastomer, High Temperature, Fluid, and Compression Set Resistant", MIL-R-83248A, February 17, 1984.

<sup>58</sup> Ibid., p. 1.

<sup>59</sup> Ibid., p. 3.

<sup>60</sup> NASA memorandum, William Ray, "Visit to Precision Rubber Products Corporation and Parker Seal Company", EP 25 (19-23), February 6, 1979, p. 1.

<sup>61</sup> Ibid.

<sup>62</sup> Ibid., p. 2.

<sup>63</sup> Ibid.

The need for additional testing of the present design was also discussed and it was agreed that tests which more closely simulate actual conditions should be done.<sup>64</sup>

As a result of the foregoing data, the Committee has arrived at the specific Findings and Recommendations contained in Chapter V.

---

<sup>64</sup> Ibid.



## VIII. LAUNCH OPERATIONS

### INTRODUCTION

The purpose of this section is to document the series of decisions that culminated in the launch of STS 51-L on January 28, 1986. In Section A, the discussion details the Flight Readiness Reviews used to assess the mission's readiness, and also describes the teleconference on the night of January 27 when Thiokol engineers attempted to delay the launch. Also discussed are the circumstances surrounding the uncertainty represented by ice covering the launch pad's gantry.

Section B describes a specific example where the launch crew in the Firing Room waived a launch commit criterion. The discussions that took place on the subject indicate that the alternate procedure used as a justification for the waiver should not have been allowed, since the environmental conditions on the morning of January 28 were outside the limits specified for the alternate procedure.

#### A. THE STS 51-L LAUNCH DECISION

##### *Discussion*

Before each flight of the Space Shuttle, the ground support team carries out a series of meetings that are collectively known as the Flight Readiness Review. Policy guidance for this procedure is supplied by NASA Program Directive 710.5A, which states:

It is the policy of the Associate Administrator for Space Flight (AA-SF) to make an assessment of mission readiness prior to each flight. This will be accomplished by a consolidated Flight Readiness Review (FRR) of all activities/elements necessary for safe and successful conduct of the launch, flight, and post-landing operations. . . . The FRR will be preceded by detailed readiness reviews (pre-FRR's) on individual elements, including cargo, under the cognizance of the responsible Managers.<sup>1</sup>

The FRR policy directive offers the following guidance to project and program managers regarding the expected content of their presentations:

The Project/Element Managers will conduct pre-FRR's to develop their readiness assessment and are responsible for the FRR briefing content in their particular area.<sup>2</sup>

As for the agenda at these reviews, the directive has this to say:

---

<sup>1</sup> James Abrahamson, NASA, Headquarters, "Space Shuttle Flight Readiness Reviews," SFO-PD 710.5A, September 26, 1983, p. 1. See Appendix VIII-A.

<sup>2</sup> *Ibid.*, pp. 1-2.

The presentation of agenda items will normally include a brief status summary with appropriate supporting detail on significant items and conclude with a readiness assessment. The presentation topics and scope should be developed from the pre-FRR's and should:

- (1) be that required to provide the AA-SF with the information needed to make a judgment as to flight readiness;
- (2) review recent significant resolved problems and prior flight anomalies when necessary to establish confidence;
- (3) cover all problems, open items and constraints remaining to be resolved before the mission;
- (4) establish the mission baseline configuration in terms of all significant changes since the last STS mission (changes to be considered include hardware, software, vehicle servicing/checkout, launch commit criteria, flight plans, flight rules and crew procedures);

Within the above guidelines, the scope of the review should cover status and issues in areas such as: vehicle checkout, shortages and open work, unexplained anomalies, hardware failures, prior flight anomalies, certification/verification, as-built hardware configuration versus certified hardware list, Critical Items List (CIL), development, qualification and reliability testing, wavers and deviations, limited life components, launch critical spares, sneak circuits, system safety/hazards and flight margins. . . .<sup>3</sup>

In the case of STS 51-L, no deviation from normal procedure apparently occurred. This means that the Solid Rocket Motor, containing the seal that apparently failed, proceeded through the usual eight levels of review at Thiokol's Wasatch Division, Marshall Space Flight Center, the STS Program Office at Johnson Space Flight Center, and the Associate Administrator's review at NASA Headquarters.<sup>4</sup>

The Flight Readiness Review process for STS 51-L began on December 11, 1985, at Thiokol's Utah plant. No information is presented in the briefing charts used that day regarding the continuing failure of the SRM joint seals. The chart entitled "STS-61C (STS-32) (SRM-24) Performance" has only one entry: "TBD [to be determined]."<sup>5</sup>

Post-flight disassembly of STS 61-C SRB hardware following its launch on January 12 revealed that erosion of the primary O-ring had occurred in the aft field joint of the left motor. Hot gas had also bypassed the primary seal in the left nozzle joint. Erosion of the primary seal had also occurred in the nozzle joint of the right motor.<sup>6</sup>

Under the terms of the FRR Policy Directive, such damage would appear to require discussion: "the scope of the review should

<sup>3</sup> *Ibid.*, pp. 2-3.

<sup>4</sup> Table I (page 44) indicates the date and scope for each of these eight reviews.

<sup>5</sup> Thiokol, "STS-51L (STS-33) Solid Rocket Motor (SRM-25) Flight Readiness Review," TWR-15380, December 11, 1985, chart 1-1. See Appendix VIII-B.

<sup>6</sup> Rogers Commission Report, Volume II, p. H-3.



cover status and issues in areas such as . . . prior flight anomalies. . . ."<sup>7</sup>

However, according to Mr. McDonald and Mr. Kennedy, Thiokol normally took about one week to prepare a discussion of problems noted in the initial inspection following SRB hardware disassembly.<sup>8</sup>

It would seem logical, when faced with the lack of data from the previous hardware set, to expand the search to other previously-flown hardware. On 61-A, hot gas had bypassed the primary seals in both the center and aft field joints of the left motor.<sup>9</sup>

The right motor suffered erosion of the primary O-ring in the nozzle joint.<sup>10</sup>

The SRBs from 61-B suffered erosion of the seals in both nozzle joints, with gas bypassing the primary seal of the left nozzle.<sup>11</sup>

The Associate Administrator's policy directive is not alone in stressing that any available information capable of assisting with an assessment of flight readiness should be presented at a readiness review. Marshall's Shuttle Projects Office policy guidance uses virtually identical language. Under "Shuttle Policy Guidance," it states, "*Review Concept: The Shuttle Projects FRR will employ a delta review concept from prior reviews and previous STS missions.*"<sup>12</sup>

In his letter announcing the STS 51-L Marshall Center FRR, Dr. Lucas wrote:

Each project manager must certify the flight readiness of his hardware and present supporting rationale and data so the Board can independently assess the flight readiness . . . Emphasis will be placed on safety of flight and mission success, including potential impact of prior flight anomalies.<sup>13</sup>

Apparent in the STS 51-L process, however, is that the continuing SRM seal problem did not receive such treatment. The "delta review concept" referred to above, according to Mr. McDonald, meant that the contractor was obligated to step back only to the previous mission for comparison.<sup>14</sup>

For 51-L, there was no previous mission to compare data with, since 61-C had not yet flown. Anomalies on STS 61-A and 61-B were not discussed, Mr. McDonald said, because they had already been dispositioned in the FRR's for 61-B and 61-C.<sup>15</sup>

The Marshall Space Flight Center FRR conducted by Dr. Lucas occurred only one day after the 61-C launch. Mulloy's presentation

<sup>7</sup> SFO-PD 710.5A, p. 3.

<sup>8</sup> Discussions with Allan McDonald and Carver Kennedy, Thiokol (Wasatch Operations), Brigham City, Utah, September 4, 1986.

<sup>9</sup> Rogers Commission Report, *loc. cit.*

<sup>10</sup> *Ibid.*

<sup>11</sup> *Ibid.*

<sup>12</sup> Robert Lindstrom, NASA, Marshall Space Flight Center, "Shuttle Project Flight Readiness Review," SOP 8000.1, December 29, 1983, p. 2. See Appendix VIII-C.

<sup>13</sup> William Lucas, NASA, Marshall Space Flight Center, "MSFC Flight Readiness Review (FRR) Board for MSFC Elements for Mission 51-L," January 7, 1986, pp. 1-2. See Appendix VIII-D.

<sup>14</sup> Discussion with Mr. McDonald, September 4, 1986.

<sup>15</sup> *Ibid.*

under STS 61-C performance noted that "all SRB systems functioned normally."<sup>16</sup>

Under "ascent," the chart shows "no anomalies."<sup>17</sup>

There is no indication in the documentation for this FRR that the continuing problem with the SRM seals was raised. The parachute recovery system was discussed at some length. Much of the presentation appears to be drawn from the booster assembly presentation made at Mulloy's Level III FRR on January 3. The only relevant item that might refer to the O-rings appears under "Certification/Verification Status," where Mulloy stated that there were "no findings from continuing analyses that changes previously established rationale for flight."<sup>18</sup>

Mr. Mulloy's presentation at the January 15, 1986, Level I FRR does not indicate any serious problems with the SRB's. Documentation under "Problems/Anomalies" lists "[n]o 61-C flight anomalies."<sup>19</sup>

Again, the focus of his presentation involved the changes made in the parachute recovery system. The SRM booster nozzle on STS 51-L would be separated at the apogee of the SRB flight path (following separation of the boosters from the Shuttle vehicle) to protect the drogue parachute from debris, and the main parachutes were to be separated at water impact to reduce risks to the divers that assisted with recovery.<sup>20</sup>

Mulloy's presentation to the Associate Administrator was not noticeably different from the presentation he made to Mr. Aldrich, the Shuttle Program Manager, at the Level II readiness review the day before. In fact, the briefing charts are identical.<sup>21</sup>

SRM seal erosion was ultimately raised during the STS-51L Flight Readiness Review cycle. Mr. McDonald stated that at the L-1 FRR Mr. Mulloy informed the Mission Management Team of the erosion damage seen on STS 61-C, characterizing it as "within the experience base."<sup>22</sup>

This evaluation of the seal erosion problem does not indicate the seriousness of the issue, and would not lead senior managers to a conclusion that the seal problem was a threat to the safety of the Shuttle. Given the historical treatment of the SRM seal problem in this process, however, it is not surprising that the STS 51-L reviews did not raise any new concerns about the integrity of the joint.

This point is readily apparent in the Commission's report. There is no implication that a serious problem exists, if Mr. Mulloy's presentations are examined. The presentation made to Level I during the STS 41-C FRR indicated that erosion was "acceptable," and offered a rationale for accepting the possibility that the phenomenon would recur.<sup>23</sup>

<sup>16</sup> Larry Mulloy, NASA, Marshall Space Flight Center, "Center Board: STS-51L Flight Readiness Review Solid Rocket Booster," January 13, 1986, Chart SRB-3.

<sup>17</sup> Ibid.

<sup>18</sup> Ibid, Chart SRB-28.

<sup>19</sup> Larry Mulloy, NASA, Marshall Space Flight Center, "STS-51L Level I Flight Readiness Review," January 15, 1986, Chart SRB-3. See Appendix VIII-E.

<sup>20</sup> Ibid., Chart SRB-4.

<sup>21</sup> Larry Mulloy, NASA, Marshall Space Flight Center, "STS-51L Level II Flight Readiness Review," January 14, 1986. See Appendix VIII-F.

<sup>22</sup> Discussion with Allan McDonald, September 4, 1986.

<sup>23</sup> Rogers Commission Report, Volume II. See Chart 15 (p. H-10) and Chart 19 (p. H-12).

Indeed, Level 1 displayed more concern about the problem than did Marshall, since Dr. Hans Mark, then Deputy Administrator, directed Marshall to prepare a review of the seal erosion problems.<sup>24</sup>

For mission 41-G, Mulloy argued that "test shows maximum erosion possible less than erosion allowable."<sup>25</sup>

In his presentation to the STS 51-E Level 1 FRR, Mulloy is seen on a videotape stating that:

The rationale that was developed after observing this erosion on STS-11 [41-B] was that it was a limited duration that was self-limiting in that as soon as the pressure in the cavity between the putty and the primary O-ring after the primary O-ring seats, or the pressure between the primary and the secondary O-ring equals the motor pressure, the flow stops and the erosion stops. The maximum erosion that we have seen previously is 53 thousandths [of an inch]—that was back on STS-2. The erosion that we saw on 51-C was 10 thousandths of an inch on one O-ring and 38 thousandths on the other, so we believe that because of the limited exposure and the fact that the leak check assures that the secondary O-ring is properly sealing against motor pressure and the fact that the duration is limited, and that we can take 95 thousandths erosion on a primary O-ring and seal against 3,000 psi which is three times the motor pressure, that this represents an acceptable risk.<sup>26</sup>

Mulloy's confidence that the SRM seal could take "95 thousandths erosion on a primary O-ring and seal against 3,000 psi which is three times the motor pressure, . . ." is based on computer modelling of the joint performance. Dr. Feynman's analysis of the model, however, questions its use as the basis for declaring the seal problem "an acceptable risk."

. . . This was a model based not on physical understanding but on empirical curve fitting. To be more detailed, it was supposed a stream of hot gas impinged on the O-ring material, and the heat was determined at the point of stagnation (so far, with reasonable physical thermodynamic laws). But to determine how much rubber eroded it was assumed this depended only on this heat by a formula suggested by data on a similar material. A logarithmic plot suggested a straight line, so it was supposed that the erosion varied as the .58 power of the heat, the .58 being determined by a nearest fit. At any rate, adjusting some other numbers, it was determined that the model agreed with erosion (to depth of one-third the radius of the ring). There is nothing much so wrong with this as believing the answer! Uncertainties appear everywhere. How strong the gas stream might be was unpredictable, it depended on holes formed in the putty. Blow-by showed that the ring might fail even though not, or only partially eroded

<sup>24</sup> Ibid., p. H-13.

<sup>25</sup> Ibid., Chart 30 (p. H-18).

<sup>26</sup> Ibid., p. H-42.

through. The empirical formula was known to be uncertain, for it did not go directly through the very data points by which it was determined. There were a cloud of points some twice above, and some twice below the fitted curve, so erosions twice predicted were reasonable from that cause alone. Similar uncertainties surrounded the other constants in the formula, etc., etc. When using a mathematical model careful attention must be given to uncertainties in the model.<sup>27</sup>

Mr. Mulloy's analysis of erosion also notes that it was a "self-limiting" phenomenon, assuming that the damage ceased after the pressure built up against the seal. His analysis demonstrates that either the primary or the secondary seal would serve the purpose.

On December 17, 1982, an amended version of the SRB Critical Items List was approved. It stated, "Leakage of the primary O-ring seal is classified as a single failure point due to possibility of loss of sealing at the secondary O-ring because of joint rotation *after motor pressurization*. [emphasis added]"<sup>28</sup>

In the "Rationale for Retention," the document states, "Full redundancy exists at the moment of initial pressurization."<sup>29</sup>

Mr. Mulloy read this to indicate that during the ignition transient, the seal was a Critically 1R system, a redundant seal existed, and the secondary O-ring could be relied upon. After completion of the ignition transient (approximately 600 milliseconds), the joint became a Critically 1 system.<sup>30</sup>

Congressman Roe, however, said,

We don't buy the point of view, do we measure other criticality points in degrees? My father taught me . . . [i]t is or it isn't . . . you took it from a R1 position and made it a number one position. You didn't qualify that, there is nothing in the record that qualifies it as half an R1 or three-quarters of an R1 in terms of temperature. . . . We didn't say we put them in there in number of degrees. We either did or we didn't.<sup>31</sup>

Implied in the presentation by Mr. Mulloy is that the Marshall and Thiokol engineers understood the joint's performance during the ignition transient. But, as Congressman Volkmer noted,

Mr. VOLKMER. ". . . Mr. Mulloy, it says on page 148 [of the Commission's report] that prior to the accident neither NASA or Thiokol clearly understood the mechanism by which the joint sealing took place. Do you agree or disagree with that?"

Mr. MULLOY. "I totally agree, sir."<sup>32</sup>

Also notable by its absence in Mulloy's presentation is the fact that STS 51-L had demonstrated an extreme example of blowby in the nozzle joint. It was this case that led Thiokol engineers to the

<sup>27</sup> Rogers Commission Report, Volume II, p. F-2.

<sup>28</sup> NASA, "SRB Critical Items List," Page A-6A, December 17, 1982, Sheet 1.

<sup>29</sup> Ibid.

<sup>30</sup> Rogers Commission Report, Volume V, p. 834.

<sup>31</sup> Cmte Hgs., Transcript, June 17, 1986, p. 185.

<sup>32</sup> Ibid., p. 291.

conclusion that temperature was a contributing factor to joint damage. Mr. Boisjoly explained to General Kutyna that, based on photographs of the joints on 51-C (launched at a seal temperature of 53°F) and 61-A (launched at a seal temperature of 75°F), he "concluded, and so presented on the night before the launch . . . that it was telling us that temperature was indeed a discriminator . . ." <sup>33</sup>

The appearance of the material that had bypassed the joint, according to Boisjoly, was significantly worse for 51C in appearance and extent.

For mission 51-F, even after the failure of the primary seal in the 51-B nozzle joint, Mulloy's presentation to Level 1 listed the problem as "closed." <sup>34</sup>

Chairman Roe, questioning witnesses from NASA on 17 June, learned that managers at Johnson and at Headquarters had not necessarily perceived the seriousness of the situation represented by the seal problem.

Mr. ROE. "I would like to get Mr. Mulloy to answer the question—would you repeat the nine flights and tell the Committee at what level the O-ring problem was discussed and who was at that level? . . . You mentioned again, you listed the whole nine, and tell the Committee at what level the O-ring problem was discussed. We have been going on this for seven years and then who was at that meeting?"

Mr. MULLOY. "Yes sir. I can answer part of your question. . . . I am reading from what was provided to me. It looks like it fits within the erosion. STS-11 [41-B], 41-C, 41-G, 51-E . . . , 51-F . . . , 51-I, 51-J, 61-A . . . , and 61 Bravo."

Mr. ROE. "These were a problem with the O-rings and they were discussed at Level 1?"

Mr. MULLOY. "Level 1 and Level 2."

Mr. ROE. "Therefore it is inconceivable that Level 1, which is top management, would not have understood the issue?"

Mr. MULLOY. "That is right, and I believe that has been acknowledged. . . ."

Dr. GRAHAM. "We are in fact, reviewing the records to see who was at the various Flight Readiness Reviews that occurred when the O-ring data was mentioned, and we have not yet been able to pull that together. . . ."

Mr. ROE. "So what you are basically saying is that Washington level knew of part of the problems; is that a fair comment?"

Dr. GRAHAM. "There are two pieces to this: one, what was transmitted; and what was understood. I believe what Mr. Mulloy and Dr. Lucas are addressing is what was transmitted. I don't know that they are the most appropriate people to express what was understood. That was a Headquarters issue and, in some cases, a Johnson Space

<sup>33</sup> Rogers Commission Report, Volume V, p. 784.

<sup>34</sup> *Ibid.*, Chart 130 (p. H-66).

Center issue. It is clear the issue was not perceived at the seriousness with which it actually affected the system. However, the information was transmitted to these agencies.”<sup>35</sup>

Dr. Graham’s statement is important when discussing the August 19, 1985, briefing on the joint seal problem. Thiokol and Marshall personnel did not communicate that the situation required a halt in operations until the problem of seal erosion had been solved. It should also be noted that Mr. Moore was then occupied with the failure of the SSME temperature sensors (a failure which had led to premature shutdown of a main engine on flight STS 51-F and caused the first abort-to-orbit in the program’s history), and so the briefing was attended by Mr. L. Michael Weeks, Deputy Associate Administrator (Technical) for Space Flight. A more complete analysis of his description of the situation to Mr. Moore is discussed in the section on Technical Expertise.<sup>36</sup>

Mr. Aldrich was not made aware of the briefing at all, removing Level 2 from the information flow.<sup>37</sup>

Levels 1 and 2 were not alone in their misapprehensions. the lack of understanding of the seal problem also appears in the presentations to Dr. Lucas and Mr. Reinartz at Marshall made by Mr. Mulloy. In the STS 61-C FRR cycle, immediately preceding 51-L, Mr. Mulloy was given an extensive discussion of the information obtained from STS 61-B, describing the damage to the seals, at the Level 3 SRB Project Office briefing he chaired.<sup>38</sup>

Mulloy’s presentation to the Shuttle Projects Board then noted “SRM joint O-ring performance within experience base.”<sup>39</sup>

In his presentation to the Level 1 FRR, however, Mulloy stated there were “no 61-B flight anomalies.”<sup>40</sup>

In hindsight, a fundamental error that pervades the history of the seal erosion problem is this reliance on the “experience base” argument. Unwarranted confidence existed in the analysis of the joint seal erosion problem developed by Thiokol engineers and agreed to by Marshall’s program office. There is a vital lesson to be learned in this episode, and it is best expressed by Henry Petroski, from the School of Engineering at Duke University.

*Dismissing the single structural failure as an anomaly is never a wise course* (emphasis added). The failure of any engineering structure is cause for concern, for a single incident can indicate a material flaw or design error that renders myriad structural successes irrelevant. . . . In en-

<sup>35</sup> Cmte Hgs, Transcript, June 17, 1986, pp. 203-206.

<sup>36</sup> Section VI.B.1.c. of this report.

<sup>37</sup> “The second breakdown in communications. . . ,” Mr. Aldrich testified before the Commission, “is the situation of the variety of reviews that were conducted last summer between the NASA Headquarters Organization and the Marshall Organization on the [joint seal problem] and the fact that that was not brought through my office in either direction—that is, it was not worked through by the NASA Headquarters Organization nor when the Marshall Organization brought these concerns to be reported were we involved. And I believe that is a critical breakdown in process and I think it is also against the documented reporting channels that the program is supposed to operate to.” Rogers Commission Report, Volume V, p. 1490.

<sup>38</sup> Larry Wear, NASA, Marshall Space Flight Center, “Flight Readiness Review SRM-24 (STS 61-C),” December 2, 1985, Charts 3-2; 3-2B. See Appendix VIII-G.

<sup>39</sup> Rogers Commission Report, Volume II, p. H-3.

<sup>40</sup> *Ibid.*

gineering, numbers are means, not ends, and it ought rightly to have taken only the failure of a single bridge to bring into question the integrity of every other span. . . . The common expectation of the engineer and the layman is that the road will not lead to bridges that collapse.<sup>41</sup>

Clearly evident is the fact that the Flight Readiness Review procedure cannot compensate for poor engineering analysis. The FRR is similar to a checklist and will not necessarily discover problems not on the list. The technical rationale presented by Level 3 managers is assumed to reflect the best engineering judgment available. Relying on this expertise, managers in more senior positions at NASA were misinformed regarding the severity of the problem of seal erosion and its critical importance to flight safety.

The Committee is also concerned about the so-called "launch constraint" imposed on the Shuttle system following STS 51-B, and the role this constraint was expected to play in the Flight Readiness Review process. The term "launch constraint" would seem to indicate that the Shuttle should not be launched until the problem giving rise to the constraint was solved. This is apparently not the case, according to Mr. Mulloy:

The problem assessment system is in place at the Marshall Center as a tool to assure—it is a tool used by our quality and a reliability assurance organization to assure that problems that occur in flights and in ground test, in development, our qualification motor tests that would have a bearing on the flight or the upcoming flights, that that is documented and tracked. That problem assessment system shows in the case of the O-ring erosion, it shows essentially the same information, in many cases identical information to what is in the Flight Readiness Reviews. It is the basis for continuing to fly given the observations we are seeing.<sup>42</sup>

Testifying before the Commission, Mulloy had also made this distinction.

Chairman ROGERS. "Let's go back just a bit, because I think it is helpful to me if you—you use words that I understand a little bit. What caused the constraint to be put on in the first place?"

Mr. MULLOY. "The constraint was put on after we saw the secondary O-ring erosion on the nozzle, I believe."

Chairman ROGERS. "Who decided that?"

Mr. MULLOY. "I decided that, that that [the joint seal erosion] would be addressed, until that problem was resolved, it would be considered a launch constraint, and addressed at Flight Readiness Reviews to assure that we were staying within our flight experience base. . . ."

Dr. RIDE. "Why didn't you put a launch constraint on the field joint at the same time?"

<sup>41</sup> Henry Petroski, *To Engineer is Human: The Role of Failure in Successful Design* (New York: St. Martin's Press, 1985), pp. 69-73.

<sup>42</sup> Cmte Hgs, Transcript, June 17, 1986, p. 205.

Mr. MULLOY. "I think at that point . . . the logic was that we had been discussing the field joint, the field and nozzle joint primary O-ring erosion. This erosion of [STS 51-B's] secondary O-ring was a new and significant event, very new and significant event that we certainly did not understand. Everything up to that point had been that the primary O-ring, even though it does experience some erosion, does seal. What we had evidence of was that here was a case where the primary O-ring was violated and the secondary O-ring was eroded, and that was considered to be a more serious observation than previously observed."<sup>43</sup>

The Marshall Space Flight System Problem Assessment System (PAS) was tracking the problem of nozzle joint primary O-ring erosion in Record A09288, "O-Ring Erosion in the Case to Nozzle Joint."<sup>44</sup> The record was apparently opened on July 10, 1985, some two months following the launch of STS 51-B on April 29, 1985. The last entry in this record is dated January 23, 1986, and begins "Resolution." It continues with a rationale for closing out the tracking record. Part of the rationale is quoted here:

Analytical studies based on both impingement erosion and blowby erosion show that this phenomenon has an acceptable ceiling since implementing the above changes [in performance of the seal leak check and in stacking procedures]. Recent experience has been within the program data base. The seal improvement program plan will continue until the problem has been isolated and damage eliminated to the SRM seals.<sup>45</sup>

An identical entry appears in PAS Record A07934, "Segment Joint Primary O-ring Charred." Though tracking problems with the field joint seals, work on the nozzle joint problem was included "as they are the same generic problem."<sup>46</sup>

The logic behind this "resolution" of the O-ring problem is not readily apparent. As the field joint tracking report notes, "The O-rings in the SRM segment ass[embly] joints are designed as press[ure] seals & are not intended to be exposed to hot gases."<sup>47</sup>

Yet, in the rationale for closing out these tracking reports, it is stated that "[p]rimary O-ring erosion is expected to continue since no corrective action has been established that will prevent hot gases from reaching the primary O-ring cavity."<sup>48</sup>

The rationale ad described also appears to violate the directive, issued in 1980, that addresses the question of launch constraints. "All open problems coded criticality, 1, 1R, 2 or 2R," it stated:

will be considered launch constraints until resolved (recurrence control established and its implementation effectivity determined) or sufficient rationale, i.e., different con-

<sup>43</sup> Rogers Commission Report, Volume V, p. 1510.

<sup>44</sup> NASA, Marshall Space Flight Center, "O-Ring Erosion in the Case to Nozzle Joint," Problem Assessment System Record Number A09288, February 26, 1986. See Appendix VIII-H.

<sup>45</sup> *Ibid.*, p. 2.

<sup>46</sup> NASA, Marshall Space Flight Center, "Segment Joint Primary O-ring Charred," Problem Assessment System Record Number A07934, March 7, 1986, p. 4. See Appendix VIII-I.

<sup>47</sup> *Ibid.*, p. 1.

<sup>48</sup> *Ibid.*, p. 5.



figuration, etc., exists to conclude that this problem will not occur on the flight vehicle during prelaunch, launch or flight.<sup>49</sup>

The Committee attributes this situation to the concept of "acceptable erosion," which is more fully discussed in Chapter VII of this report.

According to testimony before the Commission, these tracking records for O-ring erosion were closed out upon receipt of a letter from Mr. McDonald dated December 10, 1985.<sup>51</sup>

This was apparently a mistake. As Mr. Mulloy and Mr. Wear explained to the Commission,

Mr. MULLOY. ". . . Now, the entry that is shown in there that the problem was closed prior to 51-L is in error. What happened there was, one of your documents here which we did not discuss is the letter from Mr. McDonald to Mr. Wear which proposed that this problem be dropped from the problem assessment system and no longer be trapped [tracked] for the reasons stated in Mr. McDonald's letter. That letter was in the review cycle . . . . After Mr. Wear brought this letter to my attention, my reaction was, 'we are not going to drop this from the problem assessment system because the problem is not resolved and it has to be dealt with on a flight-by-flight basis.' Since that was going through the review cycle, the people who run this problem assessment system erroneously entered a closure for the problem on the basis of this submittal from Thio-kol. Having done that, then for the 51-L review, this did not come up in the Flight Readiness Review as an open launch constraint, so you won't find a project signature because the PAS system showed the problem was closed, and that was an error."

Chairman ROGERS. "Who made the error? Do you know?"

Mr. MULLOY. "The people who do the problem assessment system."

Mr. WEAR. "Mr. Fletcher, and he reports within our quality organization at the Flight Readiness Review, at the incremental Flight Readiness Reviews . . . . At my review and at Larry's review, there is a heads up given to the quality representative at that board for what problems the system has open, and they cross-check to make sure that we address that problem in the readiness review. On this particular occasion, there was no heads up given because their PAS system considered that action closed. That is unfortunate."<sup>52</sup>

Mr. Mulloy's discussion with Chairman Roe, and his description provided to the Commission, indicate that the NASA Safety, Reliability and Quality Assurance (SR&QA) organization should play a

<sup>49</sup> Robert Lindstrom, NASA, Marshall Space Flight Center, "Assigning Launch Constraints on Open Problems Submitted to MSFC PAS," September 15, 1980, p. 1. See Appendix VIII-J.

<sup>51</sup> Rogers Commission Report, Volume V, p. 1509.

<sup>52</sup> Ibid.

significant role in the Flight Readiness Review process. The information available on this topic suggests that this was not the case. The Committee is concerned by the invisibility of SR&QA in this area.<sup>53</sup>

First, the number of people operating in the SR&QA organization has apparently been declining since the Apollo program. The decline at Marshall is among the most severe, according to NASA's internal estimate.<sup>54</sup>

The obvious conclusion is that SR&QA has fewer people to oversee the myriad details involved in preparing for Flight Readiness Reviews, in addition to their other duties.

Second, there is nothing to show what evaluation SR&QA personnel had made of the joint seal erosion problem. The recurring nature of this problem, and the Criticality-1 status of the joint, argue that SR&QA should have paid close attention to this situation, including the execution of an independent test program and presentations of their evaluation at Level 3 Flight Readiness Reviews.

Third, though management of the PAS system is apparently the responsibility of the SR&QA organization, they appear to exercise little control. The system is operated under contract by Rockwell, data is entered by hardware manufacturers, and the only technical analysis that appears in the reports on joint seal erosion was developed by Mr. Wear or his deputy, James Thomas, in the SRM program office. There is no input, either concurrence or dispute, registered by SR&QA personnel. Even more important, as illustrated by Mr. Mulloy's testimony, problem reports can too easily be removed from the system.

Fourth, the PAS tracking records do not support the testimony of Mr. Mulloy and Mr. Wear before the Commission. The entry entitled "Resolution" is dated January 23, 1986, while the FRR in Mr. Wear's SRM Project Office occurred on December 17, 1985, and the FRR in Mr. Mulloy's SRB Project Office took place on January 3, 1986. It is also interesting to note that the PAS Record, dated February 26, 1986, shows "Status Open."<sup>55</sup>

If Mr. Mulloy's and Mr. Wear's testimony is accurate, SR&QA should still have raised the issue of seal erosion as a concern at their reviews. No evidence exists that this occurred.

The Committee, however, is concerned not only about the SR&QA organization at Marshall. The Commission noted in its report that "[t]he Problem Reporting and Corrective Action document (JSC 08126A, paragraph 3.2d) requires project offices to inform Level II of launch constraints. That requirement was not met. Neither Level II nor Level I was informed."<sup>56</sup>

Testifying before the Committee, however, Mr. Mulloy argued that both levels were informed.

Mr. VOLKMER. "Even though . . . you continued to see erosion of the O-ring, you continued to waive the launch constraint?"

<sup>53</sup> See also "Safety, Reliability and Quality Assurance," Section VI.B.2.c(2) of this report.

<sup>54</sup> This is documented in Section VI.B.2.c(1) of this report.

<sup>55</sup> PAS Record A09288, p. 1.

<sup>56</sup> Rogers Commission Report, Volume I, p. 159.

Mr. MULLOY. "That is correct, sir, on the basis of the rationale or the explanation as to why that was an acceptable risk that was presented to me by Morton Thiokol, reviewed and approved by my management. . . ."

Mr. VOLKMER. "Was JSC [the Johnson Space Center] informed of the problem?"

Mr. MULLOY. "Through the Flight Readiness Review and through the submission of this problem to the problem tracking system at JSC. I do not know what distribution was made at JSC when it goes down there. The report also goes to the Chief Engineer's office at Headquarters."

Mr. VOLKMER. "It is my understanding that we had some testimony earlier from Mr. Aldrich that he wasn't knowledgeable that there was a launch constraint."

Mr. MULLOY. "That is entirely possible, sir, I don't know what distribution was made, and I have testified, and I think—I have testified that it wasn't briefed in the Levels 2 and the Level 1. When I went—"

Mr. VOLKMER. "That is right."

Mr. MULLOY. "—that 'we have a problem, the concern is flight safety, the rationale for continuing to fly is this.' That was not briefed in the context of 'this is a launch constraint in the problem assessment system,' and it is entirely possible that if that report, whatever distribution is made of that report at Houston, that he might not have seen that."<sup>57</sup>

It is quite likely that neither Mr. Moore nor Mr. Aldrich was made aware of the launch constraint on the SRM. SR&QA personnel at Johnson and at NASA Headquarters should have received these reports described by Mr. Mulloy and tracked them as they did similar launch constraints on other Shuttle hardware. What steps they took to assure that these constraints were raised at the Flight Readiness Review for these management levels is less clear. The Committee's review of the FRR's for the six missions subject to the launch constraint on SRM nozzle joint seals does not indicate a greater level of discussion took place because the constraint was in force, except for the STS 51-F FRR where an explanation of the 51-B failure was required.

The rationale for closing out these problems on the problem assessment system stated that "status will continue to be provided in the Flight Readiness Reviews and in formal technical reviews at Thiokol and MSFC."<sup>58</sup>

Without a change in the prevailing technical evaluation of the problem, however, it is unlikely that proper action to correct the overall problem would have been undertaken.

On the eve of the launch, Thiokol engineers attempted to change this prevailing technical evaluation. In a teleconference on the night of January 27, they presented data demonstrating that the low temperatures in the area would impair the function of the O-ring seals inside the joint. After NASA managers expressed con-

<sup>57</sup> Cmte Hgs Transcript, June 17, 1986, pp. 284-85.

<sup>58</sup> PAS Record A09288, p. 3.

cern about the delay such constraints would have on the flight schedules, Thiokol's management withdrew and met with their engineers again; only this time, the managers would not listen to further argument about aborting the flight. Thiokol then recommended that the launch be allowed to proceed.

Launch operations were terminated at 12:36 p.m. Eastern Standard Time (EST) on January 27 because of high crosswinds at the launch site. At 2:00 p.m. EST, the Mission Management Team met and decided to attempt a launch at 9:38 a.m. EST January 28. The weather was expected to be clear but cold with temperatures in the low twenties. There were concerns about the facilities and various water drains but no concerns were expressed about the O-ring and the Solid Rocket Boosters. All members of the team were asked to review the situation and call if any problems arose.

At Thiokol's Wasatch Division in Utah, Mr. Robert Ebeling<sup>59</sup> met with Mr. Boisjoly at about 2:30 p.m. Mountain Standard Time (MST) on the afternoon of January 27. They were joined by other Thiokol engineers. Mr. Ebeling was concerned about predicted cold temperatures at the Kennedy Space Center. When he was questioned by the Rogers Commission he responded:

. . . The meeting lasted one hour, but the conclusion of that meeting was engineering, especially Arnie [Thompson], Roger Boisjoly, Brian Russell, myself, Jerry Burns, they come to mind, were very adamant about their concerns on this lower temperature, because we were way below our data base and we were way below what we qualified for.<sup>60</sup>

Later Mr. Ebeling called Mr. McDonald at the Kennedy Space Center. Mr. McDonald remembered the call, saying:

He called me and said they had just received some word earlier that the weatherman was projecting temperatures as low as 18 degrees F [Fahrenheit] sometime in the early morning hours of the 28th and that they had some meeting with some of the engineering people and had some concerns about the O-rings getting to those kinds of temperatures.<sup>61</sup>

Mr. Ebeling wanted Mr. McDonald to get some accurate predicted temperatures for the Cape so he could make some calculations to determine what could be expected of the O-rings. McDonald told him he would get the temperature data for him and call him back. Mr. Carver Kennedy, Vice President of Space Services for Thiokol, working at the Kennedy Space Center, obtained the information. Mr. McDonald then relayed the information to Mr. Ebeling in Utah. The information indicated that the temperature was to get as low as 22° in the early morning hours, probably around 6:00 a.m., and that they were predicting a temperature of about 26° at the intended time of launch, 9:38 a.m. on the 28th.<sup>62</sup>

<sup>59</sup> Solid Rocket Motor Igniter and Final Assembly Manager, Thiokol.

<sup>60</sup> Thiokol, Robert Ebeling, Interview before the Presidential Commission on the Space Shuttle Challenger Accident, March 19, 1986, p. 13.

<sup>61</sup> Rogers Commission Report, Volume IV, p. 715.

<sup>62</sup> *Ibid.*

Mr. McDonald then called Mr. Cecil Houston, the Resident Manager for the Marshall office at Kennedy Space Center, and told him of Thiokol's concerns with the low temperature and potential problems with the O-rings. Mr. Houston said he would set up a teleconference including Marshall and personnel at Thiokol in Utah.<sup>62a</sup>

---

<sup>62a</sup> Table II lists the principal participants in the teleconference on January 27, 1986.

TABLE 11

PRINCIPAL PARTICIPANTS IN THE TELECONFERENCE  
ON JANUARY 27, 1986

At Kennedy Space Center, Florida

Thiokol	Allan McDonald	Director, Solid Rocket Motor Program Office
Thiokol	Jack Buchanan	Manager, KSC Resident Office
MSFC	Lawrence Mulloy	Manager, Solid Rocket Booster Project Office
MSFC	Stanley Reinartz	Manager, Shuttle Projects Office
MSFC	Judson Lovingood	Deputy Manager, Shuttle Projects Office

At Marshall Space Flight Center, Alabama

MSFC	George Hardy	Deputy Director for Science and Engineering
------	--------------	---------------------------------------------

At Thiokol Wasatch Operations, Utah

Thiokol	Jerald Mason	Senior Vice President, Wasatch Operations
Thiokol	C.G. Wiggins	Vice President and General Manager, Space Division
Thiokol	Robert Lund	Vice President for Engineering
Thiokol	Joseph Kilminster	Vice President, Space Booster Programs
Thiokol	Roger Boisjoly	Staff Engineer, Applied Mechanics
Thiokol	Robert Ebeling	Manager, SRM Ignition System, Final Assembly, Special Projects and Test
Thiokol	Arnold Thompson	Supervisor, Structures Design

Mr. Houston then called Dr. Judson Lovingood, Deputy Shuttle Project Manager at Marshall, to inform him of the concerns about the O-rings. Mr. Houston asked Dr. Lovingood to set up a teleconference with senior project management personnel, including Mr. George Hardy, Deputy Director of Science and Engineering at Marshall, and with Thiokol personnel. Dr. Lovingood called Mr. Stanley Reinartz, Marshall's Shuttle Project Office Manager, a few minutes later and informed him of the planned teleconference.

The first phase of the teleconference began at 5:54 p.m. EST and included Messrs. Reinartz, Lovingood, Hardy, and others at Kennedy, Marshall and Thiokol's Wasatch plant. Concerns about the effect of low temperature of the O-rings and the joint seal were presented by Thiokol personnel, along with an opinion that launch should be delayed.

A recommendation was also made that Arnold Aldrich, the Space Transportation System Program Manager, be told of the upcoming telecon and that the fact that Thiokol had expressed some concerns. Mr. Reinartz testified before the Commission that "we did not have a full understanding of the situation as I understood it at that time, and felt that it was appropriate to do before we involved the Level II into the system."<sup>63</sup>

Testifying before the Rogers Commission, Dr. Lovingood was asked whether the possibility of a launch delay had been mentioned in this telcon on January 27. Dr. Lovingood replied:

That is the way I heard it, and they were talking about the 51-C experience and the fact that they had experienced the worst case blow-by as far as arc and the soot and so forth. And also, they talked about the resiliency data that they had.

So it appeared to me—and we didn't have all the people there. That was another aspect of this. It appeared to me we had better sit down and get the data so that we could understand exactly what they were talking about and assess that data.

And that is why I suggested that we go ahead and have a telecon within the center, so that we can review that.<sup>64</sup>

Dr. Keel, the Staff Director for the Rogers Commission, asked,

Dr. KEEL. "So as early as after that first afternoon conference at 5:45, it appeared that Thiokol was basically saying delay. Is that right?"

Dr. LOVINGOOD. "That is the way it came across to me. I don't know how other people perceive it, but that's the way it came across to me."

Dr. KEEL. "Mr. Reinartz, how did you perceive it?"

Mr. REINARTZ. "I did not perceive it that way. I perceived that they were raising some questions and issues which required looking into by all the parties, but I did not perceive it as a recommendation to delay."

Dr. KEEL. "Some prospect for delay?"

<sup>63</sup> Rogers Commission Report, Volume V, p. 919.

<sup>64</sup> *Ibid.*, p. 923.

Mr. REINARTZ. "Yes, sir, that possibility is always there."

Dr. KEEL. "Did you convey that to Mr. Mulloy and Mr. Hardy before the 8:15 teleconference?"

Mr. REINARTZ. "Yes I did. And as a matter of fact, we had a discussion. Mr. Mulloy was just out of communication for about an hour, and then after that I got in contact with him, and we both had a short discussion relating to the general nature of the concerns with Dr. Lucas and Mr. Kingsbury at the motel before we both departed for the telecon that we had set up at the Cape."<sup>65</sup>

At approximately 8:45 p.m. EST, the second phase of the teleconference commenced, Thiokol's charts and written data having arrived at the Kennedy Space Center by telefax. The charts presented a history of the O-ring erosion and blow-by in the Solid Rocket Booster joints of previous flights, presented the results of subscale testing at Thiokol and the results of static tests of Solid Rocket Motors.

Mr. Boisjoly testified:

I expressed deep concern about launching at low temperature. I presented Chart 2-1 with emphasis—now, 2-1, if you want to see it, I have it, but basically that was the chart that summarized the primary concerns, and that was the chart that I pulled right out of the [August 19] Washington presentation without changing one word of it because it was still applicable, and it addresses the highest concern of the field joint in both the ignition transient condition and the steady state condition, and it really sets down the rationale for why we were continuing to fly. Basically, if erosion penetrates the primary O-ring seal, there is a higher probability of no secondary seal capability in the steady state condition. And I had two sub-bullets under that which stated bench testing showed O-ring not capable of maintaining contact with metal parts gap opening rate to maximum operating pressure. I had another bullet which stated bench testing showed capability to maintain O-ring contact during initial phase (0 to 170 milliseconds of transient). That was my comfort basis of continuing to fly under normal circumstances, normal being within the data base we had.

I emphasized, when I presented that chart about the changing of the timing function of the O-ring as it attempted to seal. I was concerned that we may go from that first beginning region into that intermediate region, from 0 to 170 being the first region, and 170 to 330 being the intermediate region where we didn't have a high probability of sealing or seating.<sup>66</sup>

---

<sup>65</sup> *Ibid.*

<sup>66</sup> *Ibid.*, Volume IV, p. 790.



Mr. Boisjoly then presented Chart 2-2 with his added concerns related to the timing function. He mentioned in his testimony to the Rogers Commission:

We would have low O-ring squeeze due to low temperature which I calculated earlier in the day. We should have higher O-ring Shore hardness. . . . Now, that would be harder. And what that material really is, it would be likened to trying to shove a brick into a crack versus a sponge. That is a good analogy for purposes of this discussion. I also mentioned that thicker grease, as a result of lower temperatures, would have higher viscosity. It wouldn't be as slick and slippery as it would be at room temperature. And so it would be a little bit more difficult to move across it.

We would have higher O-ring pressure actuation time, in my opinion, and that is what I presented. . . . These are the sum and substance of what I just presented. If action time increases, then the threshold of secondary seal pressurization capability is approached. That was my fear. If the threshold is reached, then secondary seal may not be capable of being pressurized, and that was the bottom line of everything that had been presented up to that point.<sup>67</sup>

Asked by Chairman Rogers, "Did anybody take issue with you?" Mr. Boisjoly responded:

Well, I am coming to that. I also showed a chart of the joint with an exaggerated cross section to show the seal lifted off, which has been shown to everybody. I was asked, yes, at that point in time I was asked to quantify my concerns, and I said I couldn't. I couldn't quantify it. I had no data to quantify it, but I did say I knew that it was away from goodness in the current data base. Someone on the net commented that we had soot blow-by on SRM-22 [Flight 61-A, October, 1985] which was launched at 75 degrees, I don't remember who made the comment, but that is where the first comment came in about the disparity between my conclusion and the observed data because SRM-22 had blow-by at essentially a room temperature launch.

I then said that SRM-15 [Flight 51-C, January, 1985] had much more blow-by indication and that is was indeed telling use that lower temperature was a factor. This was supported by inspection of flown hardware by myself. I was asked again for data to support my claim, and I said I have none other than what is being presented, and I had been trying to get resilience data, Arnie [Thompson] and I both, since last October, and that statement was mentioned on the net.<sup>68</sup>

This second phase of the telecon on the evening of January 27 concluded with statements from Robert Lund, Thiokol's Vice President of Engineering. His conclusion at that time was that the Shut-

<sup>67</sup> Ibid., p. 791.

<sup>68</sup> Ibid.

tle should not fly outside Thiokol's database; that, is, that the O-ring seals should be above 53 degrees Fahrenheit before lift-off.

NASA participants in the telecon were not pleased with these conclusions and recommendations, according to Mr. Boisjoly and Mr. McDonald. Mr. Hardy, when asked what he thought about Thiokol's recommendation, was quoted to the effect that he was "appalled" at Mr. Lund's decision.<sup>69</sup>

Boisjoly also testified that Mr. Hardy said, "No, not if the contractor recommended not launching, he would not go against the contractor and launch."<sup>70</sup>

Shortly thereafter, Mr. Joseph Kilminster, Thiokol's Vice President for Space Booster Programs, was asked by NASA if he would launch and "he said no because the engineering recommendation was not to launch."<sup>71</sup>

Then, according to Mr. Boisjoly, someone in Thiokol management asked for a five-minute caucus, and at that point Thiokol cut their speakerphone off.

Chairman ROGERS. "Mr. Boisjoly, at the time that you made the—that Thiokol made the recommendation not to launch, was that the unanimous recommendation as far as you knew?"

Mr. BOISJOLY. "Yes. I have to make something clear. I have been distressed by the things that have been appearing in the paper and things that have been said in general, and there was never one positive, pro-launch statement ever made by anybody. There have been some feelings since then that folks have expressed that they would support the decision, but there was not one positive statement for launch ever made in that room."<sup>72</sup>

Asked for his recollection of these incidents, Mr. McDonald commented,

. . . And the bottom line was that the engineering people would not recommend a launch below 53 degrees F. The basis for that recommendation was primarily our concern with the launch that had occurred about a year earlier, in January of 1985, I believe it was 51-C.<sup>73</sup>

Mr. Mulloy testified:

The bottom line of that, though, initially was that Thiokol engineering, Bob Lund, who is the Vice President and Director of Engineering, who is here today, recommended that 51-L not be launched if the O-ring temperature predicted at launch time would be lower than any previous launch, and that was 53 degrees. . . .<sup>74</sup>

At 10:30 p.m. EST, the teleconference between NASA and Thiokol was recessed. The off-net caucus of Thiokol personnel lasted ap-

<sup>69</sup> Ibid.

<sup>70</sup> Ibid.

<sup>71</sup> Ibid.

<sup>72</sup> Ibid.

<sup>73</sup> Ibid., Volume IV, p. 717.

<sup>74</sup> Ibid., Volume IV, p. 604.

proximately thirty minutes at the Wasatch office. Jerald Mason, Senior Vice President for Wasatch Operations, remembered that the conversation during the caucus centered around O-rings and the history of erosion of the O-rings. Mr. Mason testified:

Now, in the caucus we revisited all of our previous discussions, and the important things that came out of that was, as we had recognized, we did have the possibility that the primary O-ring might be slower to move into the seating position and that was our concern, and that is what we had focused on originally. . . . The fact that we couldn't show direct correlation with the O-ring temperature was discussed, but we still felt that there was some concern about it being colder.<sup>75</sup>

Ten engineers participated in the caucus, along with Mr. Mason, Mr. Kilminster, Mr. Lund and Mr. C.G. Wiggins (Vice President and General Manager for Thiokol's Space Division). Arnold Thompson<sup>76</sup> and Mr. Boisjoly voiced very strong objections to launch, and the suggestion in their testimony was that Lund was also reluctant to launch.

Mr. Boisjoly, in testifying before the Rogers Commission, stated:

Okay, the caucus was started by Mr. Mason stating that a management decision was necessary. Those of us who opposed the launch continued to speak out, and I am specifically speaking of Mr. Thompson and myself because in my recollection he and I were the only ones that vigorously continued to oppose the launch. And we were attempting to go back and rereview and try to make clear what we were trying to get across, and we couldn't understand why it was going to be reversed. So we spoke out and tried to explain once again the effects of low temperature. Arnie actually got up from his position which was down the table, and walked up the table and put a quarter pad down in front of the table, in front of management folks, and tried to sketch out once again what his concern was with the joint, and when he realized he wasn't getting through, he just stopped.

I tried one more time with the photos. I grabbed the photos, and I went up and discussed the photos once again and tried to make the point that it was my opinion from actual observation that temperature was indeed a discriminator and we should not ignore the physical evidence that we had observed.

And again, I brought up the point that SRM-15 [Flight 51-C, January, 1985] had a 110 degree arc of black grease while SRM-22 [Flight 61-A, October, 1985] had a relatively different amount, which was less and wasn't quite as black. I also stopped when it was apparent that I couldn't get anybody to listen.<sup>77</sup>

<sup>75</sup> *Ibid.*, p. 759.

<sup>76</sup> Supervisor of Structures Design, Thiokol.

<sup>77</sup> Rogers Commission Report, Volume IV, pp. 792-93.

Commissioner Walker asked, "At this point did anyone else speak up in favor of the launch?" Mr. Boisjoly replied:

No, sir. No one said anything, in my recollection, nobody said a word. It was then being discussed amongst the management folks. After Arnie and I had our last say, Mr. Mason said we have to make a management decision. He turned to Bub Lund and asked him to take off his engineering hat and put on his management hat. From this point on, management formulated the points to base their decision on. There was never one comment in favor, as I have said, of launching by any engineer or other nonmanagement person in the room before or after the caucus. I was not even asked to participate in giving any input to the final decision charts.

I went back on the net with the final charts or final chart, which was the rationale for launching, and that was presented by Mr. Kilminster. It was hand written on a note pad, and he read from the notepad. I did not agree with some of the statements that were being made to support the decision. I was never asked or polled, and it was clearly a management decision from that point. . . .

I left the room feeling badly defeated, but I felt I really did all I could to stop the launch.<sup>78</sup>

In testimony before the Committee on June 18, 1986, concerning the caucus and the decision to overrule engineering recommendations, Boisjoly said:

When we went off the line and caucused—one of the first statements that was made was that we would have to make a management decision by management people. And we continued very strongly to oppose that and we argued as vigorously as we could argue, and when you look up into people's eyes you know you have gone about as far as you can go.

And so both Mr. Thompson and I just plain frankly backed off. You had to be there and you had to see the looks and feel the experience that it didn't really make any difference what further you were going to say, you were just not going to be heard.<sup>79</sup>

At approximately 11 p.m. EST, the Thiokol/NASA teleconference resumed, with Mr. Kilminster stating that they had reassessed the problem, that the temperature effects were a concern, but that the data were admittedly inconclusive. He read the rationale recommending launch and stated that to be Thiokol's recommendation. Mr. Hardy of NASA requested that it be sent in writing by telefax both to Kennedy and to Marshall, and it was.<sup>80</sup>

<sup>78</sup> Ibid.

<sup>79</sup> Cmte Hgs, Transcript, June 18, 1986, p. 85.

<sup>80</sup> The Committee has learned that (apparently due to an error in duplicating the relevant chart) the copy of this telefax that was sent to the Rogers Commission did not contain the standard caveat that was printed below the company logo on the original telefax. The caveat reads, "Information on this page was prepared to support an oral presentation and cannot be considered complete without the oral discussion." At the Committee hearings on June 18, 1986, Mr. U.

Having heard the debate and this decision, Mr. Reinartz accepted the conclusion and ended the teleconference. He asked whether anyone had any further concerns. None were expressed. Commissioners then asked what steps he had taken after the decision was made.

Chairman ROGERS. "I guess the question that still lingers in my mind is, in the Navy we used to have an expression about going by the book, and I gather you were going by the book. But doesn't the process require some judgment? Don't you have to use common sense? Wouldn't common sense require that you tell the decisionmakers about this serious problem that was different from anything in the past?"

Mr. REINARTZ. "In looking at that one, Mr. Chairman, together with Mr. Mulloy when we looked at were there any launch commits, any Level II, as I perceived during the telecon, I got no disagreement concerning the Thiokol launch between any of the Level III elements, the contractor, with Mr. McDonald there. I felt that the Thiokol and Marshall people had fully examined that concern, and that it had been satisfactorily dispositioned based upon the evidence and the data that was supplied to that decision process on that evening, from that material, and not extraneous to what else may have been going on within Thiokol that I had no knowledge of."

Chairman ROGERS. "Okay. Thank you. I'm sorry for the long interruption."

Mr. REINARTZ. "Based upon—and as we skipped over it is only a point to illustrate, Mr. Chairman, that in our discussion about the parachute with KSC and Mr. Aldrich, was to indicate that there was a clear area there where we had a very direct responsibility to inform them of the situation, which Mr. Mulloy did. And after a discussion of that issue, Mr. Aldrich concluded that the launch should proceed in that nature. Based on the results of the meeting and the conclusions out of the meeting, Mr. Mulloy and I informed the Director of Marshall, Dr. Lucas, and the Director of Science and Engineering, Mr. Kingsbury, on the 28th of January—about 5:00—of the initial Thiokol concerns and engineering recommendations, the final Thiokol launch recommendation, that I felt had led to a successful resolution of this concern."

General KUTYNA. "Could I interrupt for a minute? You informed Dr. Lucas. He is not in the reporting chain?"

Mr. REINARTZ. "No, sir."

General KUTYNA. "If I could use an analogy, if you want to report a fire you don't go to the mayor. In his position as center director, Dr. Lucas was cut out of the reporting chain, much like a mayor. If it was important enough to

---

Edwin Garrison, President of the Aerospace Group at Thiokol, testified that the caveat at the bottom of the paper in no way "... insinuates ... that the document doesn't mean what it says." (Cmte Hgs, Transcript, June 18, 1986, p. 43.) After further investigation of this deletion, the Committee has concluded that it was not significant.

report to him, why didn't you go through the fire department and go up your decision chain?"

Mr. REINARTZ. "That, General Kutyna, is a normal course of our operating mode within the center, that I keep Dr. Lucas informed of my activities, be they this type of thing or other."

General KUTYNA. "But you did that at 5 o'clock in the morning. That's kind of early. It would seem that's important. Why didn't you go up the chain?"

Mr. REINARTZ. "No, sir. That is the time when we go in, basically go into the launch, and so it was not waking him up to tell him that information. It was when we go into the launch in the morning. And based upon my assessment of the situation as dispositioned that evening, for better or worse, I did not perceive and clear requirement for interaction with Level II, as the concern was worked any dispositioned with full agreement among all reasonable parties as to that agreement."

Chairman ROGERS. "Did I understand what you just said, that you told Dr. Lucas that all the engineers at Thiokol were in accord?"

Mr. REINARTZ. "No, sir. What I told him was of the initial Thiokol concerns that we had and the initial recommendation and the final Thiokol recommendation and the rationale associated with that recommendation, and the fact that we had the full support of the senior Marshall engineering<sup>81</sup> and, as George has testified, to the extensiveness of the group of people we had involved in that telecon with the various disciplines, that those three elements made up the final recommendation."

Mr. Horz. "Mr. Reinartz, are you telling us that you in fact are the person who made the decision not to escalate this to a Level II item?"

Mr. REINARTZ. "That is correct, sir."<sup>82</sup>

According to NASA's Program Directive SFO-PD 710.5A, Mr. Reinartz may have been required to report the matter to the Associate Administrator for Space Flight. A portion of that directive reads as follows:

Significant items occurring subsequent to the FRR will also be reported to the AA-SF. Actions that can be easily accomplished without safety, mission, or launch impact and do not violate flight vehicle or launch complex configuration integrity or cause basic changes to launch commit criteria, flight rules, flight plan, or abort and alternate mission plans, need not be reported.<sup>83</sup>

Was this telecon, and the decision reached, "significant?" NASA's request that the Thiokol decision be put in writing indi-

<sup>81</sup> Staff review of teleconference materials used by Marshall engineers Wilbur Riehl (Chief, Nonmetallic Materials Division) and John Miller (Technical Assistant to the SRM Manager) indicates that some of the Marshall engineering staff shared the concerns expressed by Thiokol engineers.

<sup>82</sup> Rogers Commission Report, Volume V, pp. 917-18.

<sup>83</sup> SFO-PD 710.5A, p. 3.

cates that MSFC personnel felt the situation was significant, since in effect Thiokol was reconfirming the flight readiness of the SRM.

It is also interesting to note, in light of the directive, that Mr. McDonald testified before the Commission to the effect that Mr. Mulloy had made some "fairly strong comments . . . about trying to institute new launch commit criteria."<sup>84</sup>

Mr. Mulloy responded to this by explaining what he had attempted to say.

Mr. MULLOY. "The total context, I think, in which those words may have been used is, there are currently no Launch Commit Criteria for joint temperature. What you are proposing to do is to generate a new Launch Commit Criteria on the eve of launch, after we have successfully flown with the existing Launch Commit Criteria 24 previous times. With this LCC, i.e., do not launch with a temperature greater than [sic] 53 degrees, we may not be able to launch until next April. We need to consider this carefully before we jump to any conclusions. It is all in the context, again, with challenging your interpretation of the data, what does it mean and is it logical, is it truly logical that we really have a system that has to be 53 degrees to fly? . . ."

General KUTYNA. "Mr. Mulloy, if in fact the criteria were 53 degrees, it would have an impact not only on this launch, but on the shuttle program. . . . It is a fairly important decision to say you can't launch below 53 degrees, isn't it?"

Mr. MULLOY. "Yes, sir, I agree with that. I cannot describe the impacts, but, as I say, based upon our previous experience and our actions in flying subsequent vehicles after 51C, I found that to be a surprising conclusion. . . ."

Mr. SUTTER. ". . . [I]nstead of saying you have to wait until next April to launch, the thing that you do is you go and there were three different levels of improvements that were discussed. The thing to do then was to put those improvements in the program, not infer that these engineers are saying, we're throwing a ringer at you that says don't launch until next April. I think that is putting those engineers into a little bit of a hot seat. And if they're trying to do their job and say, hey, we ought to do something about this, there ought to have been more attention paid."<sup>85</sup>

The Rogers Commission report included the statement, "It is clear that crucial information about the O-ring damage in prior flights and about the Thiokol engineers' arguments with the NASA telecon participants never reached Jesse Moore or Arnold Aldrich, the Level I and II program officials, or J. A. Thomas, the Launch Director for 51-L."<sup>86</sup>

Based on the available evidence, the Committee is unable to conclude whether or not Mr. Moore or Mr. Aldrich, with the informa-

<sup>84</sup> Rogers Commission Report, Volume IV, p. 721.

<sup>85</sup> *Ibid.*, Volume V, pp. 843-45.

<sup>86</sup> *Ibid.*, Volume I, p. 101.

tion available to them that day, would have reached a decision to stop the launch had they been informed of this meeting. It does appear, however, that a three-hour telecon, in which arguments are raised about launch commit criteria and the contractor is asked to reconfirm the flight readiness of his hardware fall under the definition of the policy directive. At the very least, the STS Program Manager should have been presented the new declaration of flight readiness with an explanation of why it had been developed. This should have been a necessary addition to the Certificate of Flight Readiness prepared after the Flight Readiness Review.

The Committee also reviewed tapes and transcripts of conversations that took place in the Firing Room on January 28th involving discussions of the threat posed by ice on the Fixed Service Structure. Kennedy Space Center managers, in response to the predicted low temperatures that would be seen in the hours before the launch of STS-51L, took action to protect Launch Complex 39B and the Shuttle from freezing and ice buildup. This involved implementing the "freeze protection plan" for launch pad facilities. According to a post-accident report:

Two actions within the PLAN were intended to limit the ICE DEBRIS which potentially could cause damage to the Shuttle Vehicle during launch. The first action involved adding approximately fourteen hundred gallons of anti-freeze into the overpressure water troughs. The water troughs in both SRB exhaust holes have a total capacity of 6,580 gallons. The resultant antifreeze to water ratio was calculated to be 21.3%. According to the manufacturer's specifications, solution protected against freezing down to an ambient temperature of 16 degrees F. The second action involved the draining, where practical, of all water systems. Several systems, such as Firex [fire extinguishing], Deluge, and emergency shower and eyewash, were not drained. These systems were opened slightly and allowed to trickle into drains. The trickling water was found to cause drain overflows. High wind gusts then spread the water over large areas and it then froze.<sup>87</sup>

Soon after the call-to-stations on 28 January, at approximately midnight, cameras on the pad allowed engineers in the Firing Room to see that the gantry was heavily encrusted with ice. Over the Engineering Support Room communications loops, the following conversation took place:<sup>88</sup>

<sup>87</sup> NASA, Kennedy Space Center, "STS-33 (51-L) Ice/Frost Team Evaluation Report: ESS/RSS/MLP Deck/Pad Apron Icing," January 30, 1986, p. 1.

<sup>88</sup> Conversations were recorded from the Kennedy Space Center Operational Intercommunication System (OIS), which permits members of the launch crew to discuss problems that occur during the countdown, and permits them to contact various mission support facilities around the country. The transcripts provided to the Committee do not indicate the exact times at which the referenced conversations occurred, and so the flow of conversations has been reconstructed in an attempt to provide logical consistency.

Most of the transcripts in this section are drawn from OIS Channel 245, identified as the coordination channel for JSC/MSFC/KSC Engineering personnel in the Engineering Support Area at Kennedy Space Center. Conversations among Rockwell International personnel were obtained from OIS Channel 216, described as the coordination channel for JSC personnel at Johnson and Kennedy centers and Rockwell engineers in Downey, California. Transcript page numbers are those supplied by NASA.



BL. This is Bob on 245.

DIRECTOR. Go ahead, Bob.

BL. Did you ever find out any more about that water?

DIRECTOR. No, no I haven't.<sup>89</sup>

BL. Okay, I guess the thing, they don't know yet where that water's coming from and the NTD's [NASA Test Director] got some folks looking into it. I guess the thing you guys need to do is see if you can get certain cameras to look at the vehicle and to determine if there's any water getting on the vehicle that might freeze and cause problems.

DIRECTOR. I think what we need to do, Bob, we need to decide do we feel comfortable enough to let it keep running and forming ice up there, or we ought to stop and send somebody in there and try to shut it off.

BL. Yeah, okay.

DIRECTOR. Do you guys think we could form enough ice there to cause us any problem on liftoff or anything?

BL. I think you've already done that, Horace.

DIRECTOR. Well, then, we ought to stop and go out there and get the water shut off.

BL. Yeah, we're worried about an icicle up high—well, see, camera 108's on the 155 foot. . . .

ITL. 155? Yeah. So you're already getting high up, you know. And if the wind's going to be out of the north-northwest. . . .

DIRECTOR. All right, let's stop them and send the people out there and see if they can shut the water off.

ITL. I think what it is, is the fire hose—if you look right over, if you go to 108 and go like you're going to the elevator, you'll see a fire hose, looks like a fire hose draped across there...

DIRECTOR. Yeah.

ITL. . . . And I think they take the fire hose and carry it over to the shower, the eye shower. And evidently the drains that they're draining into is frozen off, or either the hose has fallen off the drain, one or the other.

DIRECTOR. Okay, we gotta work this in. We're going to tell them to go out there and shut the water off.

ITL. Okay.<sup>90</sup>

The ice/frost team was dispatched to the pad and arrived at approximately 1:45 a.m. What they found during their inspection of the Fixed Service Structure was not very encouraging to the team leader. He reported back to the Firing Room:

ITL. Horace, this is Charlie on 245.

BL. Hello, this is Bob. I think he may still be in that HIM (Hardware Interface Module) meeting [on the fire detector problem]. What do you see out there?

ITL. Okay, starting on about the 235 foot level where the top hose is, the fire hose that was draining into the shower, the hose is not really, the drain is in the shower, the hose is not really draining into the little bowl on the shower and it was spilling over. So we have a lot of hard solid ice from the 235 feet down to 195 feet where I am now. Most of it's on the west side and the north side, and about halfway in-between, the floor is one solid sheet of ice about an inch and a half thick. And down on 195 foot level, the water's on the pipe and plumbing and structure and beams all the way over to the Orbiter Access Arm [OAA]. That's as far down as we got so far.

BL. Copy.

ITL. We have some icicles about 18 inches long.<sup>91</sup>

The Ice Team leader later reported that ice was covering part of the floor on the 195 foot platform where the crew would enter the Orbiter. Part of this discussion follows:

---

Significant participants in these conversations include:

DIRECTOR: Director of Engineering, Kennedy Space Center.

BL: Chief, Mechanical Systems Division, Shuttle Engineering Directorate.

LD: Launch Director, STS 51-L.

ITL: Ice Team Leader.

<sup>89</sup> OIS Channel 245, p. 570.

<sup>90</sup> Ibid., pp. 570-72.

<sup>91</sup> Ibid., p. 573.

BL. Charlie, is that ice going to be any kind of impediment to the crew?

ITL. Uh, not to the crew. I don't see any out here where the crew walks.

BL. How 'bout to the baskets [the emergency escape system]?

ITL. . . . Up to the what?

BL. If they had to go to the baskets for any reason, do they have a clear path through that ice?

ITL. Oh, no. When you get over that way, we got ice.

BL. So they had to get out in a hurry in order to get to the baskets, they've got to go over a sheet of ice.

ITL. Oh, yeah. On the north side, that's all one hard sheet of ice. Now, they could get to the two baskets on the south side, probably three baskets on the south side. Hold on just a minute, I'll go take a look. . . .<sup>92</sup>

ITL. Okay, Bob, I'm back.

BL. Okay. What's it look like over there?

ITL. Okay—some right at the elevator, right where the camera is, going back toward the baskets, we got ice on the floor. And the ice goes all the way across the west side of the facility, all the way over to the north corner on the floor. So it is slippery. Once you get past the west-most part of the FSS, the ice on the floor ceases, and you got a clear walkway, so all five baskets are, uh, six baskets do have a clear walkway right around the baskets. But to get between the elevator and the camera where you're looking at, there's some ice on the floor.

BL. Okay.

ITL. And including the handrails that they would be holding on to. But out here from the Orbiter Access Arm over to the camera is clear.

BL. What's your Safety guy there think about that? You got a Safety guy with you, don't you?

ITL. Yes, he's concerned. Matter of fact, there's some ice right under my feet now that I look.

BL. Charlie, Horace is back with us now. Why don't you start up your review from the 235 foot level on down again.

ITL. Okay. From the 235 foot level is where we had these little Firex systems—the hose, the rubber hose which we ran over to the shower back on the northwest corner of the FSS, so we ran it on to the eyewash shower the level below, the 235 foot level, and it was running out of the drain, you know, the little basin—it was overflowing the little basin. So we have over in that area, down to the 195 foot level on the north side of the FSS, icicles that are about 18 inches or so long, about one inch in diameter or more at their maximum diameter. This floor, the grating, over on the north side paralleling the showerway and the elevator in some places are frozen solid about two inches thick. You know, the area is like 10 [by] 10 or more.

DIRECTOR. On the floor, which floors, Charlie?

ITL. The floor of the grating, on like the 215 and there's a level between 215 and right under, between 215 and 195; there's a half-level that you go out to the hatch on the north side.

DIRECTOR. Okay.

ITL. And there's a lot of icicles hanging, you know, under the floor. As far as the east side goes, on the 195 foot level where we are now, we have about one-quarter inch or one-half inch ice. On the beam structures themselves, they go all the way over to the—right at the hinge where the Orbiter Access Arm goes out. I don't see any on the Orbiter Access Arm itself, but there is some here where I'm standing and a little bit on the floor. Just before you came on, we were talking about the slidewire—the baskets. The floor from the Orbiter Access Arm over to, back where the camera is, is fairly clean. And from the camera back to the west side, is some ice on the floor to the west edge of the FSS.

DIRECTOR. Okay.

ITL. So the crew would have to walk across one slick spot. Around the baskets themselves, it's fairly clean. But to the northwest corner of the FSS where the baskets are, there's heavy concentration of ice on the floor.<sup>93</sup>

### The discussion concluded:

DIRECTOR. Do you see anything out there that makes it unsafe for the crew?

ITL. At this time, I'd say from the elevator to the Orbiter Access Arm would be fairly good; the floor's in good shape. The elevator's got a little bit of—the doors are real hard to work but everything seems to work in that neighborhood. If they had to

<sup>92</sup> Ibid., p. 574.

<sup>93</sup> Ibid., pp. 574–76.

go to the slidewire, it'd be very slippery from the camera that you're looking at to the slidewire itself. There's an area about ten feet long where the handrails have ice on them, as well as the floor.<sup>94</sup>

This discussion is of concern to the Committee. The slidewire referred to is the means by which the Shuttle crew would evacuate the launch pad if an emergency were to occur that required a rapid exit from the pad area. Crew safety concerns should dictate that the ice situation described by the Ice Team leader is unacceptable, and that some effort to remove the ice from the floor and handrails should be made. There is no indication that this was done. If the ice could not be removed, the mission should have been delayed until the danger represented by the ice could be eliminated.

This situation, admittedly, had nothing to do with the accident that destroyed STS-51-L. However, had this been the one time that use of the pad escape system was required, the crew would very likely have been impeded in their attempt to reach the escape baskets, and the lost time might have proven fatal. This system must be operated with the expectation that it will be used, and the countdown procedure should require that no barriers to its use be present before launch.

As the Ice Team continued its inspection, the discussion in the Firing Room involved the possible threat posed by the ice problem.

BL. We're just going to ask your opinion on the debris concern. If Charlie thinks we have a concern with debris, and I guess I would find it hard to believe that we'd be concerned about it from the FSS, but if we do have a concern, can we go out there and try to clean it up a little bit?

DIRECTOR. Yeah, I think we could. I think when he gets through here, if we think there's some areas that we need to clean up a little bit, we probably could.

BL. I think Safety would probably have to make a call, myself, on the floor if they think it's, that's a concern, but. . . .

DIRECTOR. Okay, he's [ITL] on 108 now.

BL. I see him on camera 108, next to the 155 foot level.

LD. Hey, what kind of debris are you guys talking about?

BL. The icicles on the FSS.

LD. Yeah, and how is that going to hurt you?

BL. Well, that's what I'm saying. I don't think it—personally, I don't think it would, but I just wanted to. . . .

DIRECTOR. [garbled] by there, you're not gonna hit the Orbiter, but Charlie's worried about it, Gene—the acoustics releasing it and it being free when the Orbiter comes by.

LD. Boy, he's really stretching it.

DIRECTOR. Oh no, I don't know whether that's stretching it too much or not.

LD. Well, I mean if we can ignore it, we need to feel comfortable about it.

P. All right, Gene, remember the wind is coming from the northwest.

LD. We need to all know if we don't get back into tanking as soon as possible, we could possibly blow it just for that.

DIRECTOR. Yeah, we understand, Gene. . . .<sup>95</sup>

The Ice Team leader's next report was no more encouraging. Water had spilled over the platform as the drains were unable to cope with the volume of water they were asked to manage. Icicles were found on the platform handrails that could easily be knocked off.<sup>96</sup>

<sup>94</sup> Ibid., p. 576.

<sup>95</sup> Ibid., pp. 577-78.

<sup>96</sup> Ibid., p. 578.

As the team leader was explaining that the water could not be completely cut off for fear of making the situation worse.<sup>97</sup> the following conversations occurred:

LD: Hey, we gotta come out of there when you guys telling us you're pretty sure that water system's gonna work.

DIRECTOR. Yeah, you feel comfortable with what you see out there, Charlie, now?

ITL. We have a lot of ice, if that's what you mean. I don't feel comfortable with what's on the FSS.

DIRECTOR. Then what choices we got?

ITL. Well, I'd say that only choice you got today is not to go. We're just taking a chance of hitting the vehicle.

LD. You see that much ice?

ITL. Well, the problem we have is we hve a lot of icicles hanging, you know, even on the west side of the FSS here, which is only 60 feet or more from the Orbiter wing. And I'm sure that stuff is going to fall off as soon as the acoustics get to it. And you got a northwest wind, so you know, somebody will have to make that assessment. If we're worried about that little bit of ice that comes off the hydrogen vent arm, and the GOX [gaseous oxygen] vent arm, what we have over here is considerably more than that, you know—it's a hundred-fold.

DIRECTOR. You got enough ice that's over there that's big enough and got enough density to it that if it hits the Orbiter it could do some significant damage?

ITL. Yes, we do. . . . It's on the east side of the FSS. On the northeast corner of the FSS, which puts you about 65 feet or so from the vehicle. But it comes right to about where this camera is, it's right on the center thin line of the FSS, it comes that far over.

BL. Charlie, I would doubt the wind could blow that over. Are you concerned about during—after engine start, that things should kinda blow around?

ITL. Uh, yes. And the problem is it's so high, too. You know, it's way up to the top. If it were all the way down here to the bottom, it probably wouldn't be any problem.

BL. Can we go along the east side handrails and knock it off now? Isn't that the biggest concern—the east side?

ITL. Well, it's on the handrails and its on the floor underneath, too. You know, I guess it could probably be done but it'd be a job.

BL. It would take a long time, wouldn't it?

ITL. All the FACS pipes, and all the conduit and all the cable trays and then hanging down underneath the floor, you know, everywhere, on all the pieces of grating, you got little icicles hanging down.

DIRECTOR. Who do you have out there with you?

ITL. B.K., as far as my group goes.

DIRECTOR. Okay, why don't you guys go ahead and walk everything down and quick as you get—come on back, let's get with Gene and we'll sit down and talk about what we got.<sup>98</sup>

LD. Okay, why don't you do like Horace said, come on back and we'll go ahead and tank and we'll have you look at it when you go back.

ITL. Okay, and I think—you know, the Rockwell people have a program which says it probably would be all right, so contact them and let them put it in the machine and see what they get.<sup>99</sup>

As the Ice Team returned from its initial inspection, the launch director spoke to KSC's Director of Engineering about the ice situation:

LD. Yeah, we really need to do some head scratching on this ice thing and what we gonna do once we get back in. We've just about used all our hold.

DIRECTOR. Okay.

LD. What we're gonna do—we're not gonna opt to have a hold, we'll let the ice team go in just like normal, but we gonna keep counting the clock, and if we have to get ourselves into eating some of our launch window, we'll do it late.

DIRECTOR. Okay. We can do the ice inspection parallel with counting.

LD. Okay, but we need to have Rockwell in there where we need to ready to talk.

DIRECTOR. We can get Don in and we'll do that.

<sup>97</sup> Ibid.

<sup>98</sup> Ibid. pp. 579–81.

<sup>99</sup> Ibid., pp. 581–82.

LD. I don't see how in the world—we need to worry about that ice. I don't know what's going to knock it off. It's going to freeze and stay there.

DIRECTOR: I don't think it will hit the Orbiter, Gene. It'll probably come off just from the acoustics, but. . . .

LD. Yeah, as you go by, I would think . . . I would think after we start the engines, if it starts breaking loose then, I don't know how it would travel that far until, you know, the six seconds or so we are on the ground.

DIRECTOR. Yeah. We'll get everybody here; we'll talking before—while we're tanking before they go out, then we'll be ready to help make an assessment.<sup>100</sup>

The Ice/Frost Team returned to the launch pad during the scheduled countdown hold at T-3 hours. The crew was somewhat larger than usual, since their primary objective was to clear ice from the water troughs on the launch pad. The team would also be making a follow-up assessment of ice on the FSS.

According to the post-accident report, "the team arrived at Pad B at 0654 hours and departed at 0844." A summary of their activity during this time stated:

Ice in the troughs had thickened and was found to be solid. All secondary troughs except the northern most one in each hole now had ice. The two inboard primary hole troughs were also forming ice. . . . The "shrimp net" was employed to break up the ice and remove it. Approximately 95% of the ice was removed. The ice and unfrozen antifreeze solution was measured using an infra-red pyrometer and found to have a temperature between 8 and 10°F. . . . The pyrometer measured the MLP deck surface temperature as 12°F. On the FSS the quantity of ice had increased but the overall extent of icing was generally the same. In most cases, sheet ice was firmly adhered to the structure. Icicles could very easily be "snapped" off. Water continued to trickle down the facility—including the RSS [Rotating Service Structure].<sup>101</sup>

NASA launch team members were continuing their debate over the risk represented by the ice at this time.

LD. What do you think about the ice now?

DIRECTOR. Well, I don't know, Gene. I keep thinking there is an answer if we can find it, but we got people out talking it and I think we can make a decision on the SRB things [troughs]. I think we have the data there that we can make the right decision on that. The tower is what's going to be the one that is going to be hard to come to a decision on.

LD. But do we have any data that shows a mechanism for moving that ice across there?

DIRECTOR. That's what we're trying to see if we can come up with some kind of rationale why it won't. Charlie says we've got some data that we have moved some pieces across from basically the tower to the vehicle but we're—[Marty Ciofoletti, Vice President for Space Transportation System Integration, Rockwell International] and the guys are working with Downey to see how they feel if they come up with anything on the acoustics and things like that.

LD. Okay.<sup>102</sup>

KSC's Engineering Director then called the Rockwell liaison.<sup>102a</sup>

<sup>100</sup> Ibid., pp. 583-84.

<sup>101</sup> "Ice/Frost Team Evaluation Report," p. 4.

<sup>102</sup> OIS Channel 245, p. 595.

<sup>102a</sup> Rockwell personnel appearing in House transcripts are identified as follows:

RI: Kennedy Space Center liaison.

RTI: Director of Technical Integration.

DIRECTOR. John, on 245.

RI. Go ahead, Horace.

DIRECTOR. You guys still talking to Downey?

RI. Yeah, we haven't go anything new since I last talked to you. Larry Williams just called in. He wants to talk to Bill Hovath [?] so they are getting ready to make a call to his now.

DIRECTOR. Okay.

RI. But we haven't got anybody. You know Jack McTimmons [McClymonds]—I talked to him and all he had to offer was his old program data of how far ice would go at various wind speeds, you know, from the FSS that's not our primary concern, obviously, right now.

DIRECTOR. No, that's right.<sup>103</sup>

In the Mission Support Room in Downey, California, Rockwell support personnel were expressing the same concerns as the Ice Team Leader, and were not confident their computer model could remove the uncertainty presented by the ice. Rockwell's Kennedy Space Center liaison was asked for information.

RTI. KSC, MSR [Mission Support Room]

RI. Go.

RTI. Good morning, John. Uh . . .

RI. It's been a busy morning!

RTI. I bet—looks bad, eh?

RI. Ice does look bad, yeah. The situation we've got right now is that they're working the bags in the SRB hole; they reported slush in those bags and we were watching on TV and some of that slush was pretty big and pretty heavy. But I think we can take care of that part—I think they're gonna get that cleared up. There's a crew out there working on those right now. One of the concerns [Richard] Colonna [Orbiter Project Manager, JSC] had was reflected pressure wave problems if there was a film of ice across those bags, but it looks like they're breaking that up. The big concern is gonna be the mass of ice that is on the FSS, from the 235 foot level all the way down to the MLP [mobile launcher platform]. Every platform had had water running on it all night and they're just a—some of the closeups of the stairwells looks like, uh, something out of Dr. Zhivago. There's sheets of icicles hanging everywhere. We've had reports, back on the northwest corner, of ice, icicles—this is a couple hours ago, the crew are up there walking it down right now, so we'll probably get some updates here shortly—but the initial walkdown said icicles up to two feet long by an inch in diameter. On the northwest corner, kind of graduating down to about three inches by one-quarter inch diameter on the east side, with periodic one-foot icicles on the east side on some of the cross beams.

RTI. Sounds grim.

RI. The big concern is that nobody knows what the hell is going to happen when that thing lights off and all that ice gets shook loose and come tumbling down and—what does it do then? Does it ricochet, does it get into some turbulent condition that throws it against the vehicle? Our general input to date has been basically that there's vehicle jeopardy that we've not prepared to sign up to. . . .

RTI. Okay. We didn't see this when we had icing conditions before?

RI. No, and they didn't run the showers all damn night before. They ran the showers this time and ran'em, pretty heavily by the look of it, the drains froze up and they all overflowed.

RTI. Oh. . . .

RI. And I guess nobody watched it all night or, if they did, they didn't say anything. But, uh—is John [Peller, Rockwell Vice President for Engineering] in yet?

RTI. No.

RI. Okay. We need to—you know, somebody at his level needs to get in and try to get up to speed as fast as they can. They're going to be looking for a final position from Rockwell here very shortly. We got—Bill Frohoff is right now talking to Larry Williams of JSC. I've got Colonna and Bobola sitting here with Al Martin and myself and we're probably going to be the forcing factor on this decision. Until

RSD: Site Director for Launch Support Operations.

RTP: Thermal Protection Project Manager.

RDE: Vice-President for Engineering.

RVP: Vice President and Program Manager for Orbiter Operations Support.

RSR: Senior Representative, Mission Evaluation Room, Johnson Space Center.

<sup>103</sup> Ibid., pp. 596-97.

somebody can come up and tell us that the potential flow path is to the objects on the FSS at liftoff—you know, we're going to have to assume the worst case—but I don't think anybody is going to have that sort of data.

RTI. This is going to be a tough one.<sup>104</sup>

The Ice Team Leader reported that efforts to clear out the water troughs under the SRBs were meeting with success, and that the team was managing to clear the ice that had formed on the left SRB aft skirt.<sup>105</sup>

As this occurred, Rockwell's Site Director for Launch Support Operations was reporting from KSC to Downey. He said,

RSD. . . . [T]he situation here is that—very quickly—when Charlie gives his report, then they are gonna want to reconvene a top level management meeting here, so whatever we want to say in that meeting we're gonna have to come up with it here and now in order to be ready to say it and I guess the situation is that there are icicles all over the stand, that's the fixed service structure, all up and down it, various levels—some of the icicles are two feet long, an inch or two at the base, there are lots of small icicles hanging all over the place. What they say is that when they touch them gently that they break off and for that reason I don't think there is any doubt about the fact in my mind that when we start the SSMEs a lot of these icicles are going to break off and they're going to—and when they do break off, then what's going to happen is that they're gonna come tumbling down, they can ricochet off of the service structure and they can—then some of them wind up on top of the MLP.<sup>106</sup>

The discussion was interrupted at this point by another report from the ice team, indicating that the lower levels of the FSS had ice coverage equal to the levels already discussed. The decision was made to bring the team leader back for a report to managers, in order to decide whether the threat was sufficient to stop the launch.<sup>107</sup>

The discussion at Rockwell then resumed:

RSD: Okay. He was just reporting on one of the levels. As he, as Charlie Stevenson, of NASA, moves up and down with the ice team, they're reporting on each level and on that particular level he was reporting a significant amount of ice as the result of the overflow from the shower. You know, they left the water running in order to keep the pipes from freezing and then, I guess, some of the drains have frozen so then the water's overflowing and that's what's creating a lot of the big icicles. But at any rate, what I was getting around to, it just appears to me that when these icicles break off when they start the SSMEs some of them are very likely—in fact, I'll tell you, almost for sure—are gonna wind up on top of the MLP and then when we launch it seems to me it would be very difficult for anybody to predict where that debris would go and it appears to me that there would be a possibility of some of that debris impacting the Orbiter tiles and I don't know how our aerodynamists or analysts or anybody you know could really say that that wouldn't happen. They can predict what happens when you drop a piece of ice in the wind. They can also predict what happens due to aspiration when you start the Solid Rocket Motors and SSMEs. The real question is how do you predict what happens to ice chunks that are on top of the MLP at launch and where they go. So, at any rate, that's how we see it here at launch.

RTI. Well, one thing I guess we can see, from the view that we have, is ice on top of the MLP right now.

RSD. Yes, there is ice on top of the MLP right now.

RTI. That's unacceptable. Anything in the trough is unacceptable and any ice that would impact the vehicle during ascent is unacceptable and we can't predict what's going to happen to all that massive ice on the towers, so I think we're in a critical situation. . . .

<sup>104</sup> OIS Channel 216, pp. 340-41.

<sup>105</sup> OIS Channel 245, pp. 600-601.

<sup>106</sup> OIS Channel 216, p. 345.

<sup>107</sup> OIS Channel 245, pp. 603-604.

RTP. Most of the ice on the tower is going to end up on an MLP, probably right before SRB ignition anyway—right, A1? You think?

RTI. Well, it's going to end up looking like snow, though, isn't it?

RTP. No, this is hard ice.

RTI. Once it hits that tower it's not going to be hard ice. What we're worried about is the aspiration effects of the motion of the ice into the vehicle.

RTP. You're still going to have large chunks of ice, ice cubes. Like an ice cube.

RTI. That's unacc . . . question is, how high is, is the highest elevation of ice, what was the . . .

RTP. I think they're saying it's all the way to the top of the tower, like the 235 foot level has icicles forming and all the way down from there.

RTI. Okay.

RSD. Bob, would you say again what you were saying about the ice on the tower and the concern about that?

RTI. We really don't have a data base to know what's going to happen to the ice. We do have some information that we can get horizontal movement of the ice into the vehicle. Obviously, since it's very tenuous, it's going to be bouncing all over the place. It'll be bouncing off the J-boxes and everything else. So you're going to have some horizontal velocity of ice.

RTP. Hey, Bob, you're breaking up again.

RTI. Okay. Let me try once more. Our data base does not allow us to scientifically tell you what's going to happen to the ice. Therefore, we feel we're in a no-go situation right now.

RSD. Okay. That, Bob, is a consensus down here, too—that there's no way, that is for Rockwell, the consensus down here for Bill Frohoff and ourselves, that there's no way to predict what's going to happen, and I think that when we get into this next meeting, we need to state that as Rockwell's position and I think that's going to come up fairly soon, here. Now, I have told Dick Colonna that I suspect that's going to be the Rockwell position, I haven't told them officially. I've also told Horace that, but I haven't told him that officially, and I guess, or, uh, do you think you're ready now to, uh, for Rockwell to state that position and do you want to go back to the MER with that or how do you want to handle it?

RTI. Well, what I would like to do is get ahold of [Bob] Glysher—we're not supposed to overrule him—and talk to him about it. Is he there?

RSD. We woke him up at 4:00 this morning. He called in about an hour ago. We understood he was on the way and he's not here yet.

RTI. Okay, I'd like to stonewall it until he gets here.<sup>108</sup>

At about this time, Mr. Bill Fleming, the senior representative of Rockwell International, reported from the Mission Evaluation Room at JSC that "ice on MLP, tower and trough not acceptable to MSR [Rockwell's Downey facility]."<sup>109</sup>

Just prior to attending the meeting called by Arnold Aldrich, the Vice President and Program Manager for Orbiter Operations Support at Rockwell held the following teleconference with their Chief Engineer at Downey.

RDE. Hey, we've gone over this again. Colonna called me and wanted to see if there is a way we could give it a go. But, when all the experts have looked at it, we still have concerns with three mechanisms. One, direct transport of falling ice into the vehicle at SSME ignition and the wind is adequate to make that happen. The ten-knot wind can move it laterally like twenty feet and a fifteen-knot gust could take it laterally forty feet. So even though you might be able to placard it, it's very close with the wind you've got. Secondly, you've got a rebound mechanism, where ice falls down into the lower part of the platform and goes out. Some pretty sizeable chunks and sometimes all it does is break an icicle in two, that's clearly enough to cause significant tile damage. And, finally, the ice ends up on the MLP and in the trough is all potential debris sources at SRB ignition and liftoff and the trajectory those things take are highly unpredictable and we just note in films tended to go in different directions. So we are not in the position to, uh. . . . So we've been through the three mechanisms, none of which we can completely clear. Dr. Petrone's here; we've discussed it with him. We still are of the position that it's still a bit of Rus-

<sup>108</sup> OIS Channel 216, pp. 345-48.

<sup>109</sup> NASA, Johnson Space Flight Center, "Presidential Commission Action Item (A-301) Response," DDATF-86-36, April 7, 1986, p. 1.



sian roulette; you'll probably make it. Five out of six times you do playing Russian roulette. But, there's a lot of debris. They could hit direct, they could be kicked up later by the SRBs, and we just don't know how to clear that.

RVP. Okay. Our position fundamentally hasn't changed. We'll just go in now, we got a 9:00, we'll go in and express it. I'll let you know what happens.

RDE. And obviously, uh, you know, it's their vehicle and they can take the risk, but our position is as stated.

RVP. Okay, you got it.<sup>110</sup>

No recording exists of the meeting at 9:00 a.m. on January 28. In testimony before the Commission, Mr. Robert Glaysher stated that he told Mr. Aldrich that "Rockwell cannot assure that it is safe to fly."<sup>111</sup>

Mr. Al Martin testified that:

I also added that we do not have the data base from which to draw any conclusions for this particular situation with the icicles on the tower, and also, we had no real analytical techniques to predict where the icicles might go at lift-off. The other thing that I did was review the fact that prior to each launch there is great care taken to assure that there is no debris out on the launch pad. A day or two before launch a crew goes out and they walk down the entire tower and walk down the mobile launcher surface, and also the concrete apron around the launch pad for the purpose of removing any debris such as nuts, bolts, rocks or anything else that might be there. . . . So I was drawing a corollary between the care that is normally taken for debris and painting a picture that the icicles appeared to me to be in that same category.<sup>112</sup>

Mr. Marty Cioffoletti testified that "I felt that by telling them we did not have a sufficient data base and could not analyze the trajectory of the ice, I felt he understood that Rockwell was not giving a positive indication that we were for the launch."<sup>113</sup>

Mr. Aldrich, conversely, told the Commission that:

Glaysher's statement to me as best as I can reconstruct it to report it to you at this time was that, while he did not disagree with the analysis that JSC and KSC had reported, that they would not give an unqualified go for launch as ice on the launch complex was a condition which had not previously been experienced, and thus posed a small additional, though unquantifiable, risk.<sup>114</sup>

Aldrich concluded the meeting by deciding to recommend that the countdown continue until the ice team could return to the pad just prior to launch and make a final assessment. Aldrich testified that he told Jesse Moore about Rockwell's reservations, explained his decision, and recommended that the launch proceed unless the ice team discovered that the situation had badly deteriorated.<sup>115</sup>

<sup>110</sup> OIS Channel 216, p. 353.

<sup>111</sup> Rogers Commission Report, Volume V, p. 1013.

<sup>112</sup> *Ibid.*

<sup>113</sup> *Ibid.*, p. 1014.

<sup>114</sup> *Ibid.*, p. 1025.

<sup>115</sup> *Ibid.*

The results of the meeting were reported back to Rockwell over the communications system:

RSR: MSR, this is MER.

UKN: Go ahead.

RSR: We just got a report in from Arnie and they're going to go ahead and go into the count. They're going to go out, sweep down the pad as best they can and remove as much ice as they can and go for the launch today.

UKN. We copied that.<sup>116</sup>

In their final report, the Ice Team found that ice on the MLP in direct sunlight had begun melting. They also found that icicles had begun to fall from the upper FSS levels. Ice cube sized pieces of these icicles were found within 10 feet of the left-hand SRB hole. The west MLP deck was swept clean of ice/icicles. The water troughs were checked and found to be forming ice, which was again removed using the "shrimp net."<sup>117</sup>

In analyzing launch films after the accident, NASA found that, contrary to expectations and analysis, ice from the Fixed Service Structure did reach and impact the Shuttle vehicle during liftoff. The report stated:

Numerous launch films were viewed regarding FSS and RSS ice debris. A film (E-43) [Engineering Camera 43] looking directly in at the vehicle and FSS shows some ice falling straight down in the period between SSME ignition and vehicle ascent through approximately 20 feet. It shows that very many particles fell at approximately a 45° angle during the vehicle rise through 20 to 40 feet. This ice included sheet ice particles up to 6 in. x 6 in. and flowed down into the plumes at a point directly below the engine nozzles. Some of this struck the LH SRB. One downward looking camera (E-36) on the FSS clearly showed that a small amount of FSS ice debris reached the area of the LH SRB exhaust hole. Particles numbered 50-100 and were approximately ice-cube size. None of these or any other debris was observed to be ejected upward toward the Orbiter. Another film (E-18) looks upward from the SSME pit. This shows that after a vehicle rise of 10 ft. hundreds of ice particles flowed in below the main engine at a 45° angle. No Orbiter impacts are observed. Camera E-26 . . . reveals many small pieces of falling ice striking the LH2 TSM [liquid hydrogen tail service mast] in the period between SSME ignition and vehicle rise through approximately 25 feet. Due to aspiration, 50-100 small ice particles flowed into the LH SRB plume directly below the SRB nozzle as the vehicle rose through 4 to 25 ft. These films and others show fairly clearly that there was little or no debris damage to the orbiter [*sic*] during liftoff due to FSS/RSS icing for the conditions observed.<sup>118</sup>

In the summary and conclusions section of this report, the following statements appear:

<sup>116</sup> OIS Channel 216, p. 355.

<sup>117</sup> "Ice/Frost Team Evaluation Report," p. 5.

<sup>118</sup> NASA, "Hazard to Orbiter Tiles Posed by the Vertical Structure Ice: Mission 51-L," January 30, 1986, p. 3.

On STS-33 (51L) the actual FSS/RSS ice movement, as proven by the photographic documentation did not conform to the predictions in two important respects:

1. The ice generally did not release until after SSME ignition.

2. The ice translated several times farther toward the vehicle than predicted.

To do meaningful predictions of ice movement, the effects of aspiration must be considered. Similarly, the release time of the ice must be known.

Until the above capability is available, it should be assumed that FSS/RSS ice would be released early and pulled by aspiration into contact with the vehicle. FSS/RSS ice thereby could be judged as a potential high risk to flight safety.<sup>119</sup>

The Committee has proceeded at some length to develop the conversations regarding ice that occurred on the morning of 28 January because they illuminate tendencies that are at variance with the careful attention to safety the Nation has come to expect from NASA. It is the Committee's view that the information developed by the discussions between members of the ice team and those that took place between Rockwell personnel on this subject should have led to the conclusion that "FSS/RSS ice . . . could be judged a potential high risk to flight safety."

The Committee also notes that, in his presentation to the STS Program Manager at the 9:00 a.m. Mission Management Team meeting, the ice team leader apparently did not inform Mr. Aldrich that he had earlier recommended that the launch be held due to the ice in the pad area. There is no indication in testimony to the Commission that Mr. Aldrich knew of the team leader's comment, "Well, I'd say the only choice you got today is not to go." Had it been presented to him in those terms, the later reluctance of Rockwell to recommend a launch might have been sufficient to cause Mr. Aldrich to recommend a launch scrub. In any event, the uncertainty present in connection with this discussion should have been sufficient to cause a delay in the launch until the ice melted off the gantry. The unknown risk represented by the ice would then have been removed.

These conversations also indicate that the launch director was not operating in a manner the Committee would expect. Given his position as the senior official responsible for the preparation of the Shuttle for launch, the Committee would expect a healthy skepticism to underlie discussions he had with members of the launch crew. In contrast to these expectations these tapes demonstrate that the director was often reminding the engineering team about time, and spent much time questioning the ice team leader's analysis of the ice on the pad. There is also no indication that he took steps to see that the pad escape system was ready for use by the flight crew, if necessary.

---

<sup>119</sup> *Ibid.*, p. 4.

Finally, Congressman Ron Packard discussed with witnesses at the Committee's hearings on July 25, 1986, ways to improve contractor participation in preparing the Shuttle for launch.

Mr. PACKARD. "Mr. Davis, you spoke regarding the companies having a voice in the decisionmaking, I presume, after the FRRs—that two week interim between launch and the readiness review system. Do you believe that the companies should have more voice, less voice, or have they had any voice in whether its a go or no-go?"

Mr. DAVIS.<sup>120</sup> "Well, I can tell you how it runs now. Up to and including the L-minus-one day review, there's no doubt that every company has a very strong voice; and, as a matter of fact, at the L-minus-one review, they are required to stand up and commit their hardware as go or no-go. And those are very unequivocal commitments, also. After that time, then the reviews are more mission management meetings that are held, and as you get down into the countdown, it turns into more of a real time polling of the people that are actually controlling the launch. In those latter meetings, we are not, I would say, formally involved in those unless there is some problem with the hardware itself, the External Tank hardware. We are in Firing Room 2 in a very significant presence; we are aware of what is happening in some of the consoles. We sit behind them; we do not operate them. We are polled by the Director of Engineering prior to the launch actually proceeding, so we are sort of polled in an informal manner. We are not asked at any time after the L-minus-one for a formal go or no-go. I believe it would probably be appropriate, in terms of the Commission's desires, that indeed we be more formally involved in the mission management meetings, and that at some appropriate late time in the launch count—and I would leave that to NASA to decide—that indeed the companies be asked to declare go or no-go."

Mr. PACKARD. "A quick answer, Mr. Murphy. Do you agree?"

Mr. MURPHY.<sup>121</sup> "Yes, I agree with what Rick has said. I think that we have found out that we commit ourselves, I guess, at 20 minutes and 9 minutes by the people who are manning the consoles, but it does not rise to the management level which it should, in accordance with what Mr. Davis has stated. We would like that opportunity also."

Mr. DAVIS. "I'd like to make one other comment on that. I have never felt that if I needed to stop a launch, I could not stop it. While I have not been asked for a positive go or no-go, the ability is always there if I decide no, to stop the launch."

Mr. PACKARD. "Mr. Jeffs, do you feel the same?"

<sup>120</sup> Mr. Richard Davis, President, Martin Marietta Michoud Aerospace.

<sup>121</sup> Mr. George Murphy, Executive Vice President and General Manager, United Technologies Booster Production Company.

Mr. JEFFS.<sup>122</sup> "Yes, I think the system should be formalized more. We have great visibility as to the problems and real times, being on the net and having CRTs [console displays] and people that are involved in depth, both at Downey and at Houston, who support it, even though it's at the Cape. But especially, when you have holds or delays and what have you, it needs to be—again—upgraded in real time with, I believe, the contractor's participation with NASA management right up to the launch decision point, and a little more formal process involved in the polling of the contractors."

Mr. PACKARD. "Mr. Murphy, if you'd had that system set up prior to the accident, would the flight—would it have still gone?"

Mr. MURPHY. "It would not have influenced our position at all. Our hardware—we had stipulations on what we required on the hardware during the whole period. They were met, and so we were in a 'go' posture as far as we were concerned. It would not have affected our position."<sup>123</sup>

The Committee believes that had the hardware contractors been required by NASA to formally declare their flight readiness, it would have removed the ambiguity in Rockwell's recommendations involving the ice on the Fixed Service Structure.

#### B. LAUNCH REDLINES

Section VI.B.1.b. of this report describes the rationale for development of certain criteria that serve to indicate when the Shuttle system is experiencing problems during the countdown. On the morning of January 27 and 28, during the countdown for STS 51-L, the launch crew in the Firing Room wrote waivers to certain of these criteria in order to permit launch of the Shuttle. Tapes and transcripts from the Operational Intercommunication System demonstrate that, at least in one instance, the technical analysis authorizing the use of a backup procedure did not account for ambient temperatures below the limits specified for this procedure. Thus, a waiver should not have been granted.

Revision C, Amendment 18 of the Launch Commit Criteria specified 45 degrees Fahrenheit as the minimum redline temperature for the External Tank nose cone.<sup>124</sup>

But the ambient temperatures during the countdown were well below that. On January 27, while the Shuttle waited for liftoff, conversations indicated that the nose cone heaters were not able to maintain proper temperatures. Excerpts from the transcript of this discussion follow.

CF. Okay, go ahead, Fred.

FH. Okay, we may have a problem with propellant temperatures at that low level. We're about three degrees away from red line and losing ground right now.

CF. Because of the amount of heat that the ground system's able to put in there?

<sup>122</sup> Mr. George Jeffs, President, North American Space Operations, Rockwell International.

<sup>123</sup> Cmte. Hgs., Transcript, July 25, 1986, pp. 71-74.

<sup>124</sup> NASA, "Launch Commit Criteria and Background," Revision C, Amendment 18, JSC-16007, December 1, 1982, p. 5.1-4. See Appendix VIII-K.

FH. That's right, they're giving us all they can right now. . . .<sup>125</sup>

DIRECTOR. . . . What do you guys feel about all the temperatures we saw today, like nose cone, and all those? Think about that so we can talk about that a little bit.

M. Yeah, that's another thing we're not happy about. We think we could probably still get by with it, but we're marginal.

UKN. You know, nose cone temp. Horace, is probably gonna be down in the low 20's, maybe even below 20.

M. I think the intertank we ought to be able to keep it up high enough. . . .<sup>126</sup>

DIRECTOR. . . . Okay. You guys think that nose cone heater is putting out all we gonna be able to get out of it?

UKN. Yep. You got it full blast. You're gonna be down 18-20° tomorrow on the nose cone. And the waiver we wrote today said we're only good down to 28. That was today's. . . .

UKN. And Horace, the [intertank] heater was running full bore for quite awhile. And we were running at least 10° below the set point temperature.

DIRECTOR. What about Fred Heinrich? He on 245?

FH. I'm here, Horace.

DIRECTOR. Fred, what do you think about the flow rate, I mean the RCS temps?

FH. Okay, Grady said they can crank that thing up locally and get outside the OMRSD [Operations Maintenance Requirements and Specifications document] limit, which may be enough, but we need to get started as soon as we get in there. Otherwise, we can't get the tank warm enough. We're going to lose ground all throughout the cryo load.

DIRECTOR. Okay.

FH. We're about 3° away from red line right now. We lost some during this cryo load with full bore on the heaters.

DIRECTOR. Okay.

R. Horace, this is Robinson, We'll have to check with JSC about the upper limit on this temperature.

DIRECTOR. What do you mean?

R. —right now OMRSD is not in—it may be something else other than Fred Heinrich's temperatures.

DIRECTOR. Okay. Then you don't have no problem picking it up, though, that's the only requirement we got, right?

R. That's affirmative.<sup>127</sup>

The waiver referred to in this conversation offered the following technical rationale: "No visible ice buildup on the nose cap fairing exit area. Temperature is 12 deg F below redline."<sup>128</sup>

The waiver also read, "For STS-33 [51-L] Min LCC acceptable is 28 deg F (was 45 deg F). Ullage transducers are acceptable down to 28 deg F (was 40 deg F). Refer Note A, LCC 5.1-4."<sup>129</sup>

Note A read:

"The following purge temps are backup measurements.

GLOT 4104A PRI Nose Cone Heated Purge Temp.

GLOT 4604A SEC Nose Cone Heated Purge Temp."<sup>130</sup>

These refer to telemetry data channels. As the temperatures are received via telemetry, they are to be interpreted by means of a curve shown on page 5.1-4B.<sup>131</sup>

It is important to note that Note A applies only if the ambient temperature is between 40 and 99 degrees F. Otherwise, the redundant procedure is invalid.

As for the effect of exceeding this redline, the launch commit criteria reads:

<sup>125</sup> OIS Channel 245, p. 217.

<sup>126</sup> *Ibid.*, p. 218.

<sup>127</sup> OIS Channel 245, pp. 219-20.

<sup>128</sup> See Appendix VIII-L.

<sup>129</sup> *Ibid.*

<sup>130</sup> "Launch Commit Criteria and Background," p. 5.1-4.

<sup>131</sup> *Ibid.*, p. 5.1-4B. See Appendix VIII-K.

"The minimum redline was established for two reasons.

- A. L02 ullage pressure transducers calibrated to 40 deg
- F.
  - B. Avoid ice buildup at nose cone fairing exit."
  - "Consequences of exceeding redline;
  - 1. Ice build up and possible impact to Orbiter.
  - 2. Inaccurate ullage pressure readings."<sup>132</sup>

Engineering support communications continued with the following:

M. Horace, 245.  
 DIRECTOR. Yeah, go ahead.  
 M. Okay, one other thing's been brought to my attention. The, the LOX, the LOX ullage pressure transducers are calibrated to a minimum of 40 degrees and maximum of 140, which is what sets our minimum in the nose cone. Below that, we may get some variations in reading.  
 FH. No, that's not true, Mark.  
 M. Well, okay.  
 FH. (garbled) see I got some measure readings here from Mark was. . . .  
 M. That's what's on the LCC backup page.  
 UKN. Read the LCC backup page on the lower limit.  
 M. It says 40 degrees.  
 FH. It says for reasons of ice and frost at that the exit on the fairing.  
 M. Yeah.  
 MAC. Test on 245. (garbled) . . . 245.  
 DIRECTOR. Go ahead, Mac.  
 MAC. Hey, are you guys reading this LCC that the consequences of exceeding the nose cone temp redline? The sheet we have over here says that we will get inaccurate ullage pressure readings.  
 DIRECTOR. Okay, Mac, we understand, thank you.<sup>133</sup>

On the morning of January 28, the following discussions between engineering support personnel were also directed toward waiving the launch commit criteria on the External Tank nose cone.

UKN. Dave, they were, of course, expecting to violate those ET nose cone purge temps LCCs again. It's 20 degrees colder today than it was yesterday.  
 D. Well, I guess we'll be going down the line producing a waiver to the same effect that we produced yesterday.  
 UKN. How did we just define it yesterday for 51L? Or for this attempt for 51L?  
 D. Copy your whole question. Say again?  
 UNK. I thought we just annotated it yesterday as for 51L only.  
 D. That may be it, I'll check the waiver log. . . .  
 UNK. Dave? 161.  
 D. Go ahead.  
 UNK. Yeah, it is effectively 51L, I think we are in good shape.  
 D. OK.<sup>134</sup>

Later on the morning of the 28th, the following discussion occurred:

D. FR[Firing Room] 2, this is FR[Firing Room] 1.  
 UKN. Yeah Chris.  
 D. This is Dan. We need to send a waiver over for signatures. We're right now showing nose cone gas temps that we were discussing yesterday are down in the 12-16 degree range and the waiver that we wrote yesterday for 51L only gives us allowance down to 28 degrees F.  
 UKN. Yeah, we'll have to rewrite that waiver.  
 D. OK. You don't think we'll have any trouble getting that signed?  
 UKN. No, as long as our pressure transducers are OK.

<sup>132</sup> Ibid., p. 5.1-4.

<sup>133</sup> OIS Channel 245, pp. 220-21.

<sup>134</sup> OIS Channel 161, p. 289. Channel 161 is identified as an Engineering channel used for troubleshooting and systems integration.

D. OK. What number would you like to use on that Horace?<sup>135</sup>

Shortly after this conversation concludes, the discussion on preparing the ET nose cone temperature waiver continued. Told "[W]e're right now sitting at 10 [degrees]" KSC's Director of Engineering said:

DIRECTOR. Let's hold on a minute and then we'll write the waiver, we'll probably wanna go below 10.

UKN. Yeah, we may just want to say no low and put a note on there that based on the pressure transducers.

Director. OK, so you want us to stand by and wait on that?

UNK. Yeah.

DIRECTOR. OK. We'll be waiting.<sup>136</sup>

If engineers intended to apply the same rationale for waivers as that used on January 27, the rationale is invalid. Ambient temperatures were well below the 40 degree limit necessary for a valid backup procedure. Therefore, the backup procedure should not have been employed.

Later, in a discussion between the Launch Director and the Director of Engineering regarding countdown problems, the following discussion about the temperature waiver took place.

LD. OK. I understand we're in the process of writing a new waiver with a lower limit of 10?

DIRECTOR. We're still looking. We'll give you a low limit.

LD. What are they running today?

DIRECTOR. It's been down as low as 10 basically.

LD. Wow!<sup>137</sup>

It was in a subsequent discussion between the same principals that the new limit was established. Their conversation, however, does not reflect that the limit was chosen by rigorous technical analysis.

LD. We have nothing else, Horace, not unless you guys are working something.

DIRECTOR. No, just the ice.

LD. OK. The only outstanding item we have right now is the one waiver on the cone temps.

DIRECTOR. OK. It looks like we probably could say about 10° and be OK on that one.

LD. OK. We'll use 10° then.

DIRECTOR. OK.<sup>138</sup>

Completing preparations of the waiver, the Director had the following conversation with one of the technicians.

DIRECTOR. OK, Jackie, in writing this waiver for nose cone temps we want to put the words on here saying that we can use the ullage transducer as an alternative way of determine redline, but we believe that yesterday Warren Wiley was saying that they had looked at those and they're good down to approximately 11 degrees and we wanted to verify that.

J. I think they did to 10 degrees.

DIRECTOR. 10?

J. Yeah.

DIRECTOR. The ullage transducers.

J. OK. Thank you, Horace.<sup>139</sup>

<sup>135</sup> Ibid., p. 296.

<sup>136</sup> Ibid., p. 297.

<sup>137</sup> Ibid., p. 299.

<sup>138</sup> Ibid., p. 302.

<sup>139</sup> Ibid., p. 305.



There is no documentation to describe the method by which the ullage pressure transducers were qualified to "10 degrees." No alternative analysis is described on the launch commit criteria to support use of this low temperature as a rationale for approving a waiver.

This example indicates that NASA personnel do not necessarily employ a sufficiently rigorous engineering analysis to the waiver of launch commit criteria during countdown. There also appears to have been some confusion as to the effect of exceeding the redline temperature. Ullage pressure readings may be critical parameters if fed to the Main Engine controllers during flight. According to NASA:

Following engine ignition at about T-4 seconds, the ullage pressure is supplemented using propellant gases vaporized in the engine heat exchangers and routed to the two ET propellant tanks. The tank pressure is maintained based on data inputs from ullage pressure sensors in each tank to control valves in the Orbiter. A combination of ullage and propellant pressure provides the necessary net positive suction pressure to start the engines. The net positive suction is the pressure needed at the main engine pump inlets to cause the pumps to work properly. The pumps, in turn, supply high-pressure liquid oxygen and liquid hydrogen to the thrust chamber. Acceleration pressure is added for operation. Fuel is forced to the engines primarily by tank pressures and, to a lesser degree, by gravity.<sup>140</sup>

Inaccurate readings from these sensors might cause the engines to operate improperly.

Also, according to the launch commit criteria, violations of launch redlines may also have occurred on the Auxiliary Power Unit (APU) gearbox lube oil (minimum redline temperature 42 deg F), and the fuel test lines (minimum temperature 41 deg F), if in fact the actual temperature were lower than minimum.<sup>141</sup>

There was also no mention of the 34.2 deg F minimum redline temperature for the SRB recovery batteries or what the temperature of the batteries was at launch.<sup>142</sup>

Under "Remarks," this criterion states, "Violation of this redline shall require an assessment to determine if a hazard exists which jeopardizes the Shuttle. . . ." <sup>143</sup>

Mr. Mulloy testified before the Commission that:

Mr. MULLOY. "I had a discussion on my SRB loop with the SRB people dealing with the question of a 24-hour turnaround to attempt to launch again at 9:38 on the 28th and the effect that the predicted cold temperatures for the night of the 27th might have on that.

The input was received back both to Mr. Reinartz and myself that we were looking at the Launch Commit Crite-

<sup>140</sup> NASA, "Space Shuttle News Reference," 1981, p. 2-40.

<sup>141</sup> "Launch Commit Criteria and Background," Amendment 20, p. G-23.

<sup>142</sup> *Ibid.*, p. G-1

<sup>143</sup> *Ibid.*

ria relative to temperatures. It was felt there was a need to look at the recovery battery temperatures that are in the forward skirt of the SRB and the fuel service module temperatures that are in the fuel service modules for the thrust vector control system in the aft skirt of the solid rocket booster.

The input received back by me was that they did not feel that would be of any concern. They were going to continue to look at it, and if any concern arose they would let me know.

I went to the 2:00 Mission Management Team and reported that there were no constraints to the solid rocket booster for a 24-hour turnaround, that we had taken a look at the recovery battery temperatures and the fuel service module. We did not feel at this time that there would be any Launch Commit Criteria for the low temperature limits that were established for those systems, but that we were continuing to assess that; should anything change in that regard, I would so report that."

Chairman ROGERS. "You referred to the Launch Commit Criteria. What were they as far as you knew in terms of weather conditions? Any?"

Mr. MULLOY. "In terms of weather conditions, yes, sir, I'm aware that there is a Launch Commit Criteria for the system for weather. There are a number of factors in that Launch Commit Criteria. One of them is the ambient temperature, which is established at 31 degrees.

Another is the sea state and winds in the SRB recovery area. Another is the cross-winds at the return to landing site runway at Kennedy Space Center. Another is the trans-Atlantic landing site weather, and another is severe weather, which is related to lightning and thunderstorms in the area."

Chairman ROGERS. "And when you say there were no constraints in the 2:00 meeting, does that mean that as far as you could see there were no problems in those areas?"

Mr. MULLOY. "No, sir, I did not evaluate those areas of the Launch Commit Criteria. What I was looking at was the specific Launch Commit Criteria items that are on the solid rocket booster and the effect that the low temperatures would have on that.

I would expect Mr. Aldrich would normally make the judgements on, and his people at the Johnson Space Center, would make the judgements on crosswinds and trans-Atlantic weather and the general ambient environment for launch."<sup>144</sup>

While there is no reason to believe that these waivers directly contributed to the cause of the accident, the low temperatures during the night of the 27th and morning of the 28th most probably did. Committee staff learned in discussions with Thiokol per-

---

<sup>144</sup> Rogers Commission Report, Volume V, pp. 827-28.

sonnel<sup>145</sup> that liquid hydrogen apparently remained in the External Tank throughout the night of January 27. This most likely played a role in the joint seal failure, since it permitted heat transfer through the ET/SRB aft attachment strut throughout the night. Of equal interest, however, is the fact that ET requires an eight-hour recovery period between tanking cycles, measured from the time the hydrogen tank low-level sensors are dry.<sup>146</sup>

If the hydrogen tank was never emptied during the turnaround procedure, this would represent a violation of those criteria. Had the criteria been observed, STS-51L would have required an afternoon window on January 28, or it might have been necessary to attempt the launch on January 29. This has not been independently confirmed, however.

---

<sup>145</sup> Discussion with Carver Kennedy, Thiokol Wasatch Operations, Brigham City, Utah, September 4, 1986. General Kutyna also noted this in the Commission's hearing on February 14, 1986 (Rogers Commission Report, Volume IV, p. 660).

<sup>146</sup> OIS Channel 245, p. 218.



## IX. DEFINITIONS OF TERMS AND ACRONYMS

AA-SF—Associate Administrator for Space Flight.  
AFPRO—Air Force Plant Representative Office.  
APU—Auxiliary Power Unit.  
BOC—Base Operations Contractor.  
BTU—British Thermal Unit.  
CAR—Configuration Acceptance Review.  
CDR—Commander.  
CDR—Critical Design Review.  
CIL—Critical Items List.  
CoFR—Certification of Flight Readiness.  
CPIF—Cost-plus, Incentive-fee.  
CTS—Call-to-stations.  
DAR—Deviation Approval Request.  
DCAS—Defense Contract Administration Service.  
DCR—Design Certification Review.  
DFRF—Dryden Flight Research Facility.  
DR—Discrepancy Report.  
EG&G—Edgerton, Germeshausen and Grier.  
ESMC—Eastern Space and Missile Center.  
EST—Eastern Standard Time.  
ET—External Tank.  
FEAT—Flight Element Assignment Table.  
FDO—Flight Dynamics Officer.  
FMEA—Failure Modes and Effects Analyses.  
FRR—Flight Readiness Review.  
FSS—Fixed Service Structure.  
GOX—Gaseous oxygen.  
GSE—Ground Support Equipment.  
HA—Hazard Analyses.  
HDP—Holddown Posts.  
ILL—Impact Limit Line.  
IPR—Interim Problem Report.  
IR—Infra-red.  
IUS—Inertial Upper Stage.  
JSC—Johnson Space Center.  
KSC—Kennedy Space Center.  
ksi—thousands of pounds per square inch.  
LCC—Launch Control Center.  
LFC—Left Forward Center.  
L/H—Left Hand.  
LOS—Loss of signal.  
LOX—Liquid oxygen.  
LPS—Launch Processing System.  
LRU—Line Replaceable Unit.  
MEOP—Maximum Expected Operating Pressure.  
MER—Mission Evaluation Room.

MLP—Mobile Launch Platform.  
 MMT—Mission Management Team.  
 MRB—Material Review Board.  
 ms—millisecond.  
 MSFC—Marshall Space Flight Center.  
 MST—Mountain Standard Time.  
 NASA—National Aeronautics and Space Administration.  
 NRC—National Research Council.  
 NRP—National Resource Protection.  
 NSTS—National Space Transportation System.  
 NTD—NASA Test Director.  
 OASCB—Orbiter Avionics Software Control Board.  
 OIS—Operational Intercom System.  
 OM—Operations Manual.  
 OMI—Operations Maintenance Instruction.  
 OMP—Operations and Maintenance Plan.  
 OMRSD—Operations Maintenance Requirements Specification Document.  
 OMS—Orbiter Maneuvering System.  
 OPF—Orbiter Processing Facility.  
 PAC—Problem Assessment Center.  
 PAS—Problem Assessment System.  
 PDR—Preliminary Design Review.  
 PGHM—Payload Ground Handling Mechanism.  
 PR—Problem Report.  
 PRCBD—Program Requirement Change Board Directive.  
 psig—pounds per square inch gage.  
 PSP—Processing Support Plan.  
 QC—Quality Control.  
 RCS—Reaction Control System.  
 R.F.—Radio Frequency.  
 RPSF—Rotation, Processing and Surge Facility.  
 RSO—Range Safety Officer.  
 RSS—Range Safety System.  
 RSS—Rotating Service Structure.  
 RTLS—Return to Launch Site.  
 SCA—Shuttle Carrier Aircraft.  
 SPC—Shuttle Processing Contractor.  
 SRB—Solid Rocket Booster.  
 SRM—Solid Rocket Motor.  
 SR&QA—Safety, Reliability and Quality Assurance.  
 SSME—Space Shuttle Main Engine.  
 STS—Space Transportation System.  
 TBD—to be determined.  
 TDRS—Tracking and Data Relay Satellite.  
 TM—Telemetry.  
 TSR—Technical Status Review.  
 TVC—Thrust Vector Control.  
 VAB—Vehicle Assembly Building.  
 VPF—Vertical Processing Facility.  
 WAD—Work Authorization Document.

# X. APPENDICES

V-A



NATIONAL AERONAUTICS AND SPACE ADMINISTRATION  
WASHINGTON, D.C. 20546

REPLY TO  
ATTN OF: HO-1

## MEMORANDUM

TO: Marshall Space Flight Center  
Attn: Mr. Garland G. Buckner  
Acting Procurement Officer *ASZ*

TERU: Marshall Space Flight Center  
Mr. Roy E. Godfrey  
SEB Chairman *RG*

FROM: HO-1/Chief, Operations and  
Review Division

SUBJECT: Selection of Contractor for Space Shuttle Program  
Solid Rocket Motors

Subject statement, signed by the Administrator, is enclosed for inclusion in the official contract file. Also enclosed is a copy of the Administrator's Statement for the SEB Chairman.

*William E. Stuckmeyer*  
William E. Stuckmeyer

Enclosure

*copy to Roy Godfrey*

\* \* \* \* \*

THIOKOL CHEMICAL CORPORATION

Thiokol presented an approach to the SRM Program which clearly focused on maximum utilization of existing facilities and low early year funding. In-house production effort would be accomplished in the Wasatch Division, Utah facility. Increment III production would be accomplished by acquisition of portion of the adjacent Air Force Plant 78 as Air Force requirements phased out. AP requirements would be met by increasing the capability of existing facilities in nearby Henderson, Nevada. Use of an existing, skilled, stable work force in a low labor rate area would minimize new hires and provide low labor costs. Thiokol's decision to fabricate nozzles in-house provided cost savings and good control over this extremely critical component; however, the Board concluded that this introduced some early risk because of lack of experience in fabricating nozzles of this size. Facility location resulted in high transportation cost of the SRM's; however, these costs were more than offset by low facility investments. The Thiokol proposal received the second highest overall Mission Suitability score by the SEB, being tied with UTC. The SEB ranked Thiokol fourth under the Design, Development and Verification Factor, second under the Manufacturing, Refurbishment and Product Support Factor and first under the Management Factor.

Design, Development and Verification

The Thiokol case design met the general SRM requirements; however, the cylindrical segment was close to the upper limits of size capability of the case fabricator. The nozzle design



included ablative materials not currently developed or characterized. This offered potential savings in program cost, but with attendant technical and program risk. An expanded characterization and development program would be required. The thickness of the nozzle material was insufficient to meet required safety factors and thus degraded reliability. The amount of material required to correct the deficiency was substantial and the deficiency could require a redesign of the metal portions as well as the ablative portions. The design was complex and would contribute to difficulty in manufacturing. The Thiokol motor case joints utilized dual O-rings and test ports between seals, enabling a simple leak check without pressurizing the entire motor. This innovative design feature increased reliability and decreased operations at the launch site, indicating good attention to low cost DDT&E and production. The thickness of the internal insulation in the case aft dome was marginal and created a technical risk.

Thiokol provided comprehensive test plans and development verification objectives; however, they proposed to verify propellant burning characteristics by testing four to six full scale mixes which was excessive, and could be reduced by establishing correlations with smaller mix size data during DDT&E. Also, Thiokol proposed to hydroburst two motor case assembly specimens, whereas one test would be sufficient.

#### Manufacturing, Refurbishment and Product Support

Thiokol had extensive processing experience with their proposed propellant formulation, having processed over 150 million pounds of this general type of propellant. Thiokol's major weakness in this area of evaluation was in the area of case fabrication. The segment fabricator would be unable to fabricate the case segments strengthened with stiffening rings as proposed by Thiokol for alternate water entry load conditions, if required. This would probably require a case and grain redesign. Thiokol's manufacturing approach provided a good mechanized method of installing insulation, coupled with an innovative method of preparing the insulation surface for the liner by peeling off a dacron cloth from the inner surface of the insulation. A minor weakness in the manufacturing approach was the decision to fabricate nozzles in-house due to Thiokol's lack of experience in fabricating nozzles of this size.

Thiokol proposed to utilize existing facilities which, with minor modifications, were totally adequate for all three increments. The one exception to this was a failure to meet Quantity Distance safety requirements between casting pits for Increment III, however, there are ways to adequately cure this problem. Thiokol maximized the refurbishment of components and the potential cost savings provided by refurbishment. Another less significant strength was the enhancement of segment assembly provided by three alignment pins thereby reducing the assembly hours on the launch pad. Thiokol failed to provide enough new cases and nozzles to meet the launch schedule. Eight additional cases and nozzles would be required to provide assurance that launch dates could be met.

#### Management

Thiokol structured the development program so that all major costs were deferred to the latest practicable date. This resulted in low early year funding, which is a key program objective. The availability of an operating plant, with ample experienced personnel and a proven organization which could be phased to the SRM effort with minimum modification added considerable maturity and confidence and proved to be cost effective. The Board considered this to be a major strength for all three increments. A strong matrix management was evident and key line organization supervisors were experienced and had worked together as a team on many successful development and production programs such as Minuteman and Poseidon. Strong management participation and visibility in variance analysis was another strong feature as was the approach to corrective actions and their effect on estimate-to-complete. Procurement Management was thorough and well planned. SRM commodity purchases would be consolidated with that of other programs at Wasatch, which should result in lower cost. The Procurement of major items was well matched to overall SRM schedule requirements. Thiokol proposed a strong Configuration Management System which included thorough identification and traceability during DDT&E, production and refurbishment. The tentative decision to make the molded and tape wrapped nozzle in-house was considered a strength in this area. It would contribute to the low cost-per-flight goal by using available resources, avoiding subcontract fees, lowering overhead rates, and taking advantage of lower cost labor. The inherent risk management aspects also were considered.

In the area of Key Personnel, the proposed Program Director was considered exceptionally strong and had successfully performed as a Project Manager on other major programs. He is widely known for his excellent performance. The proposed Deputy Program Director would also be the Chief Project Engineer. He had important and successful engineering management roles in previous major motor programs and has an excellent reputation in the trade.

Although adequately qualified for their proposed assignments, the proposed Functional Managers and their Team Members in the Project Organization did not reflect the depth of experience available in the Functional Departments of the Thiokol matrix type organization and had not previously performed as a team. This was not considered a significant weakness by the Board because of the strong experienced matrix organization at Thiokol.

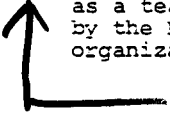

\* \* \* \* \*

V-B



TWR- 14359

**PROGRAM PLAN**  
**PROTECTION OF SPACE SHUTTLE SRM**  
**PRIMARY MOTOR SEALS**

4 MAY 1984

DR NO. 5-6

PREPARED FOR

**NATIONAL AERONAUTICS AND SPACE ADMINISTRATION**  
**GEORGE C. MARSHALL SPACE FLIGHT CENTER**  
**MARSHALL SPACE FLIGHT CENTER, ALABAMA 35812**

**CONTRACT NAS8-30490**

**WBS 1.1.1.2.3**

***Thiokol* / WASATCH DIVISION**

**A DIVISION OF THIOKOL CORPORATION**

**P O Box 524, Brigham City, Utah 84302 801/883-3811**

2000000000

PROGRAM PLAN  
PROTECTION OF SPACE SHUTTLE SRM  
PRIMARY MOTOR SEALS

Prepared by:

Brian Russell  
B. G. Russell, Manager  
SRM Ignition System

Approved by:

Bob Ebeling  
R. V. Ebeling, Manager  
Igniter, Final Assy,  
& Static Test

A. J. McDonald  
A. J. McDonald,  
Director  
Solid Rocket Motor

Released by:

J. G. Tibbitts  
J. G. Tibbitts  
Data Management

TWR-14359

20 25 30 35 40 45 50 55 60 65 70 75 80 85 90 95

## PROGRAM PLAN

 PROTECTION OF SPACE SHUTTLE SRM  
 PRIMARY MOTOR SEALS

## 1.0 INTRODUCTION

There have been incidents on SRM flight and static test motors where a primary o-ring has been slightly charred by hot gases which penetrated through the vacuum putty barrier. Motors affected thus far are STS-2A aft field joint, QM-4 nozzle joint, STS-11A forward field joint, STS-11B nozzle joint, and STS-13A nozzle joint. This program plan will result in defining the solution to this o-ring char.

## 2.0 OBJECTIVE

The program objectives are to systematically isolate the problem and to eliminate damage to SRM seals.

## 3.0 APPROACH

The program approach will consist of analysis, subscale (hot) tests, full-scale joint tests, and final verification in motor static testing.

The analysis will attempt to identify the cause of o-ring erosion, its acceptability, and justification. It will identify specific design or process changes which will eliminate further o-ring charring. Studies will be performed showing the effects of material variation characteristics, putty layup configurations, and fresh materials versus environmentally exposed putty. In conjunction with these analyses, a thorough study will be performed on material from alternate sources.

Testing will include laboratory material characterization, small motor hot tests simulating effects on cavity volume variations, flow patterns, exposure of o-ring and lubrication effects. The burn time of small hot motors will be in the range of 3 - 30 seconds depending on the results of previous small scale motor test results. Morton Thiokol also recommends that actual full-scale segment joint tests be used to evaluate pressurization effects on putty layup arrangements and flow changes due to final assembly of the joints. It is further suggested that a group of experienced people from MSFC and MTI be selected to witness the entire joint preparation, assembly, leak testing, and postfire teardown at KSC and MTI/Clearfield facilities. This team will also review all analyses, laboratory tests, subscale hot test, and support team reviews.

TWR-14359

REVISION \_\_\_\_\_

DOC NO.	VOL
SEC	PAGE

2

FORM TC NO. 1000

### 3.1 Analysis

The following tests shall be performed on the vacuum putty as a minimum. If further testing is required, it shall be performed and documented. Some of the tests are currently being performed on the existing putty, but are listed to assure that presently available data are summarized in the ensuing report. These tests will have to be repeated on any potential new putty. (See section 3.1.5)

#### 3.1.1 Chemical Composition

An analysis will be performed on the putty to determine solids content, asbestos fiber (or other filler) content, chromate content, binder makeup, and all other applicable tests described in STW4-2847, Putty, Vacuum Seal.

#### 3.1.2 Physical Properties

Tests shall be developed and conducted to determine adhesive strength of the putty (tackiness), strain capability, compressibility, and resistance to heat, erosion, and pressure shock (at SEM ignition).

##### 3.1.2.1 Environmental Effects

The putty will be conditioned in controlled temperature and humidity environments, including ambient conditions at Utah and Florida, then tested for all physical properties and appropriate chemical properties such as non-volatile content and water solubility.

#### 3.1.3 Aging

An aging program will be conducted on putty in Utah and Florida. The program should run for five years with particular emphasis during the first year at 3, 6, 9, and 12 months. Chemical and physical tests shall be performed at each stage of aging. The putty will also be checked for shrinkage and silicone migration from the paper backing used as a separator in the roll form.

#### 3.1.4 Compatibility of Putty With Other Materials

The putty will be tested to determine effects of its mixing with Conoco HD-2 grease, cured NBR rubber, and both fresh and saltwater. If the materials react, properties of the resultant material will be established. Tests shall also determine whether the resultant material is corrosive to the D6AC case.

REVISION \_\_\_\_\_

FORM TC NO. 1000

11  
10  
9  
8  
7  
6  
5  
4  
3  
2  
1

DOC NO.	TWR-14359	VOL
SEC	PAGE	3

3.1.5 Second Source for Putty

A second (or third) source of putty is desirable to prevent further supply problems, which could seriously impact the Space Shuttle program. A development program will be implemented to test alternate putty candidates per the preceding requirements as a minimum. Subscale firing tests shall use the alternate putty to establish confidence to install the new putty in FWC-SRM static firing DM-6 for putty qualification.

There are three alternate source candidates at this time: Plastic Sealer 579.6 from Inmont Corporation of Georgetown, Ontario, with asbestos and Plastic Sealer 579.6 from Inmont Corporation, St. Louis, without asbestos. General Sealants is developing a high temperature putty that will also be screened.

3.1.6 Viton Characteristics

To aid the accuracy of the hot gas jet analysis, tests will be run to determine the erosion rate of Viton. These data, along with results from other tests described in this plan, will be used when the analysis is redone.

3.2 Subscale Firing Tests

3.2.1 Five Inch CP Motor

To verify that hot gas jets through the putty openings is correct, tests will be conducted which induce a gas jet impingement on an o-ring using five inch CP motors as test beds. Under tightly controlled conditions (environmental and mechanical), this data will be assessed to more fully understand what is happening in the SRM applications.

If a meaningful subscale joint test can be devised with putty in it, it will also be performed using the five inch CP as the hot gas source.

3.2.2 40 Lb. Char Motor

Depending on the results of the five inch CP hot testing, it may be desirable to include larger scale test motors having putty installed. Morton Thiokol is investigating the 40 lb. char motors. If required, such tests shall be performed to further verify the change in putty layup, type, and/or other filler materials.

3.3 Full-Scale Joint Tests

Tests shall be performed using a full-scale SRM field joint to verify the subscale results of the candidate putty layup configurations as affected by the actual joint assembly and leak test procedures. The "short stack" hardware is preferred for use instead of SRM case segments for ease of assembly and inspection. The following questions shall be answered as minimum requirements of this test sequence:

U  
C  
C  
C  
C  
C

REVISION \_\_\_\_\_

DOC NO. TMR-14350 VOL. \_\_\_\_\_  
SEC \_\_\_\_\_ PAGE 4



- a. What is post assembly pressure in the cavity between the putty and the primary o-ring?
- b. What is the minimum pressure required to blow through the putty?
- c. What is the maximum acceptable leakage rate at 200 psig which meets the 50 psig leak test criterion?
- d. How is o-ring seating affected by pressure and time?
- e. What is the proper amount of HD-2 grease to be applied to the joint metal surfaces to minimize the free volume between the vacuum putty and the primary o-ring?
- f. What is the effect of case eccentricity during segment mating on the flow of vacuum putty in the joint?
- g. What dimension and weight controls are required to assure the vacuum putty layup is consistent and adequate?

Potential fixes will be investigated such as inducing paths through the vacuum putty at regular circumferential intervals to prevent localized o-ring damage caused by small, supersonic gas jets. The concept of a soft rubber barrier between the putty and primary o-ring will also be investigated. In addition, leak check procedures, particularly those employing the use of a flow meter, will be examined with acceptable and non-acceptable (leaking) o-rings. In all instances the behavior of the putty shall be closely monitored.

Results of the above described tests will be extrapolated to the nozzle to case joint and tests using a full-scale nozzle fixed housing and aft dome will be conducted, if necessary, to verify the adequacy of any change resulting from the field joint tests.

A plan, TWR-13983, has been prepared to check the putty configuration of the igniter to case joint. These tests will also be conducted and the results will be summarized in the final report.

#### 3.4 Full-Scale Static Test

All potential design changes will be adequately tested on the subscale level and shall be incorporated into the SRM-FWC static firing DM-6 for qualification. A critical postfire inspection will be performed on the new configuration as well as the baselined portions of the DM-6 joints.

An analysis will be performed to assess the results of the FWC-SRM field joints as they compare to the HPM-SRM field joint. The field joints are shown in figures 1 and 2 for HPM-SRM and FWC-SRM, respectively.

TWR-14359

REVISION \_\_\_\_\_

DOC NO.	VOL
SEC	PAGE 5

FORM TC NO. 1009

### 3.5 Review and Witness Team

A review and witness team shall be established consisting of experienced engineers from Morton Thiokol and NASA to inspect and assess all test results. Anomalous conditions of joints from flown motors shall be critically inspected by members of this team. The team will determine the course of action to be taken as intermediate and final results become available.

### 4.0 SCHEDULE

The attached schedule reflects the time available to complete the testing and qualification of the preceding items.

### 5.0 REPORT

A comprehensive report shall be prepared by Engineering documenting the tests and results. The original shall be released after the development testing, but prior to DM-6. A revision shall be released after DM-6 and a second and final revision shall be published after the aging program.

REVISION \_\_\_\_\_

FORM TC NO. 1000

DCC  
 NO. TM-14350 VOL \_\_\_\_\_  
 SEC \_\_\_\_\_ PAGE \_\_\_\_\_

6

PC 055511

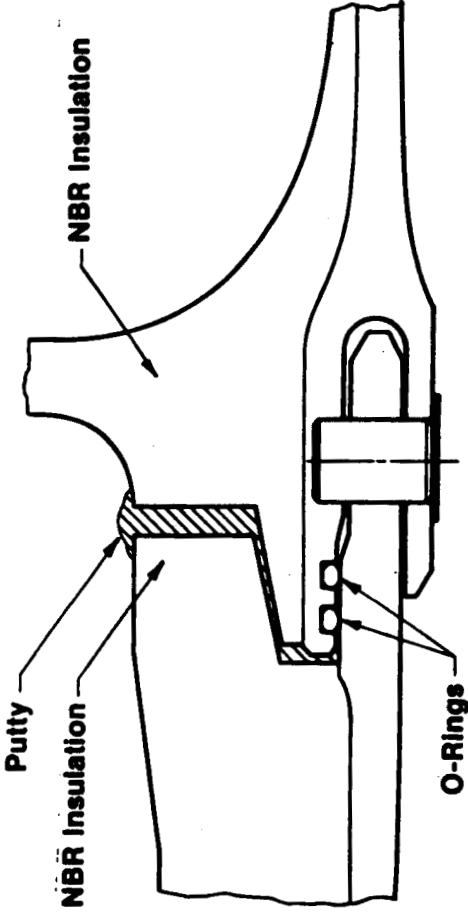

### SRM-HPM Field Joint

Figure 1

Proximal Corporation, a subsidiary of  
**MORON THOROL, INC.**  
Wausau Division

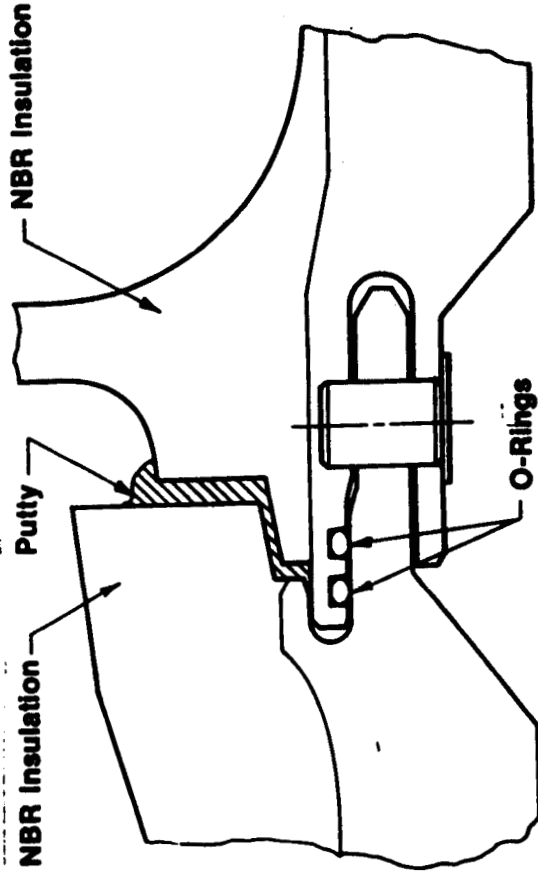

**FWC-SRM Field Joint**

Figure 2

Practical Corporation, a subsidiary of  
**MORRISON THORNDIKE INC.**  
Waltham Division

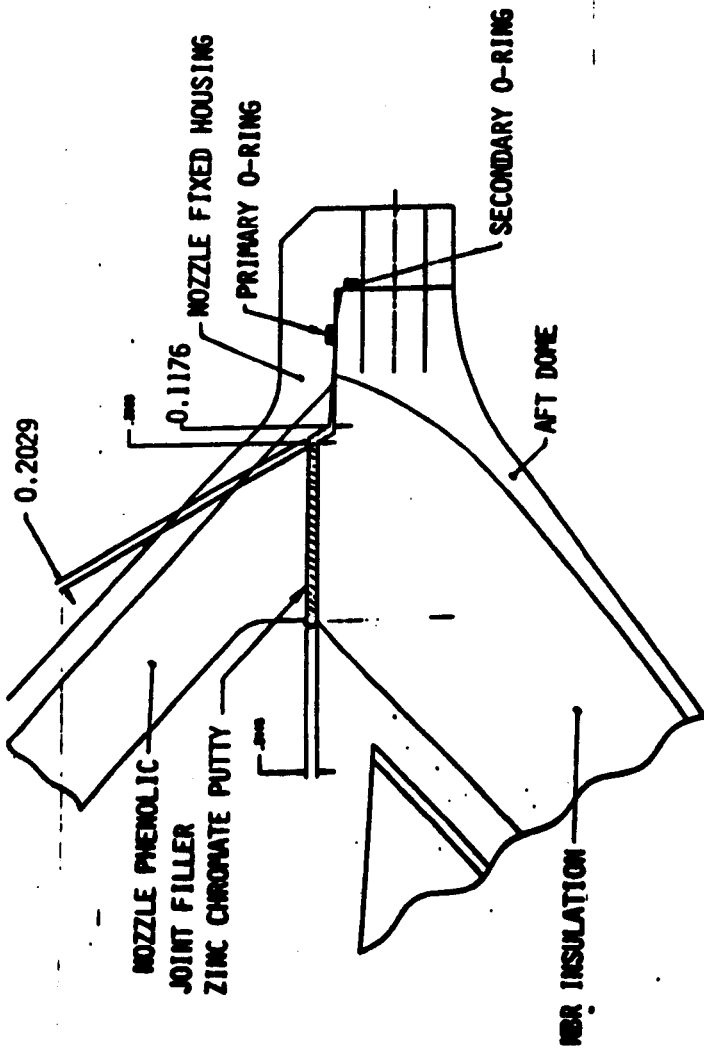

SRM NOZZLE-TO-CASE JOINT

REF. 2

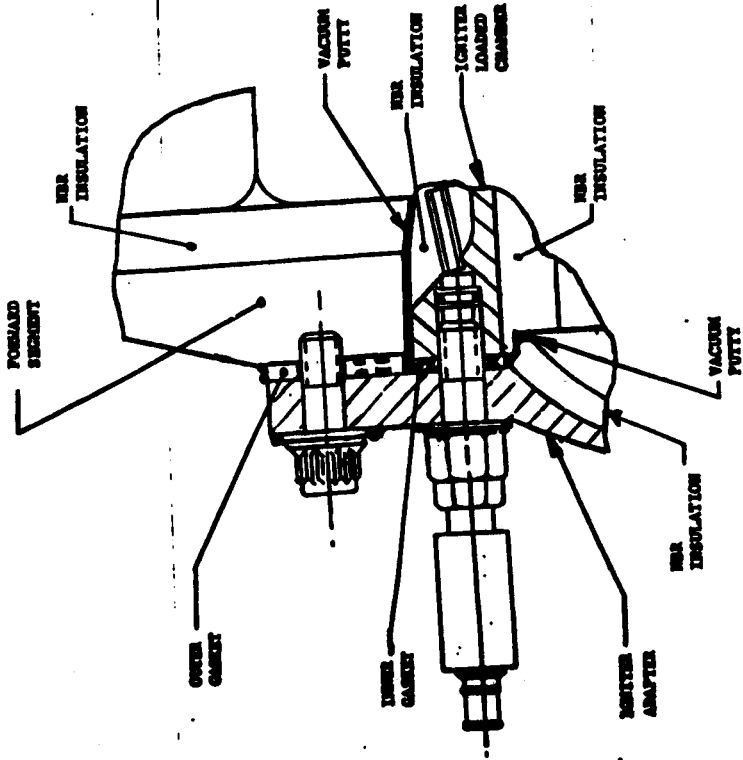

SEMI IGNITER-TO-CASE JOINT

PROGRAM SCHEDULE

Task	1964		1965		Remarks
	Jan	July	January	July	
3.1.1, 3.1.2 and 3.1.3 Test Plan	3.10.72	3.10.72	3.10.72	3.10.72	3.10.72
Test Complete					
3.1.2.1 Florida Test Complete					
3.1.3 Aging					
Test Start					
3, 4, 9, 12 Month Test					
3.1.4 Second Source					
Test Plan, see 3.1.1					
Analytical Test Complete					
Remote Firing					
SW-6 Installation					
Mobile Unit					
Field Jobs					
3.1.6 Firing Demonstration					
3.1.7 Fire Jam of Tests					
Test Plan					
Test Complete					
3.1.8 All Round Over, if Required					
3.2 Full Scale Joint					
Field Joint Test Plan					
Test Complete					
Engineer Joint Test Complete					
3.4 SW-6 Tests					
SW-6 vs. SW-6 Joint Analysis					

## DISTRIBUTION

<u>NAME</u>	<u>QUANTITY</u>	<u>MAIL STOP</u>
J. C. Kilminster	1	E00
A. J. McDonald	1	E00
K. V. Ebeling	1	E11
L. G. Bailey	1	E11
H. H. McIntosh	1	E03
J. R. Elwell	1	E12
B. G. Russell	1	E11
J. H. Keller	1	E12
F. C. Brasfield	1	E12
B. C. Brinton	1	250
P. C. Petty	1	250
R. M. Boiejoly	1	250
S. B. Pendleton	1	281
D. J. Hammon	1	280
L. H. Sayer	1	281
K. R. Eckhardt	1	281
R. C. Bunker	1	281
K. E. Wollenhaupt	1	281
G. G. Gorman	1	281
P. S. Shadleskey	1	281
A. R. Thompson	1	287
E. D. Brown	1	243
D. B. Davis	1	243
P. G. Russell	1	242B
F. E. Beres	1	240
S. H. Cardall	1	242B
W. B. Johnson	1	574
D. M. Fullmer	1	574
J. W. Galbraith	1	913B
D. M. Puskedra	1	913B
A. J. Burks	1	168
J. Trenkle	1	168
W. Coiner	1	168
F. W. Call	25	E14
M. E. Parker	1	MSFC
D. H. Harper	1	MSFC
W. L. Hankins	1	221
G. H. Schick	1	221

REVISION \_\_\_\_\_

FORM TC NO. 1099

DOC NO.	TWR-14359	VOL.
SEC	PAGE	7



V-C

National Aeronautics and  
Space Administration

George C. Marshall Space Flight Center  
Marshall Space Flight Center, Alabama  
35812



EP25 (84-49)

May 23, 1984

TO: EE11/Mr. Horton  
FROM: EP25/Mr. Miller  
SUBJECT: Evaluation of TWR-14359, "Program Plan, Protection of Space Shuttle SRM Primary Motor Seals"

The subject Program Plan has been evaluated as requested and the following comments are submitted for your consideration:

a. Page 3, Paragraph 3.1.2, **Physical Properties** - This Program Plan mentions compressibility testing of the zinc chromate putty, however no laboratory tests are proposed which will determine the extrusion characteristics (displacement in a free volume under compression load) of various candidates. This should be accomplished to provide a better understanding as to why various types of putty exhibit unlike extrusion patterns with identical layouts.

b. Page 4, Paragraph 3.1.5, **Second Source for Putty** - A second source for zinc chromate putty is desired and needed, but due to the poor performance of the Randolph putty, a more immediate need exists for development of a replacement for the present Randolph putty. Recommendation to this effect was made in Memorandum EP25 (84-35).

c. Page 4, Paragraph 3.2.2, **40-Pound Char Motor** - The 40-pound char motor should be made a definite part of the Test Program. It is vital that the test article be capable of simulating the total joint configuration as close as possible, which includes zinc chromate putty. Provisions for the installation of the putty together with extended burn time and increased volumes compatibilities are achievable with the larger motor and should be included in the total program.

d. Page 5, Paragraph 3.3, **Full-Scale Joint Tests**, Reference: first paragraph following "g". Please explain how potential fixes such as inducing paths through the putty at regular circumferential intervals and use of a soft rubber barrier between the putty and primary O-ring will be verified by hot firing prior to installation on DM-6.

e. Page 5, Paragraph 3.3, **Full-Scale Joint Tests**, Reference: Second paragraph following "g". The Test Plan should specify a hard requirement to verify all potential nozzle/aft dome joint changes on full-scale hardware. The case joint and nozzle joint configuration differences warrant separate full-scale nozzle/aft segment assembly tests.



PC 026425

f. **General** - Design changes to the insulation interfaces which will prevent degradation of the thermal barrier due to joint rounding under pressure should be investigated as a part of this effort. The present design of the case joint and nozzle interfaces where the zinc chromate putty is installed are oriented such that the joint gaps can vary from minimum to maximum dimensions around the circumference during assembly due to out of roundness and eccentricity. This condition which is present to some degree during every joint assembly operation, guarantees that some, or almost all of the zinc chromate putty in certain areas will be wiped off when the mating surfaces move parallel to each other during mating. This results in open insulation gaps with insufficient zinc chromate putty during motor operation because the joints tend to become round and concentric when the case is pressurized internally.

Questions concerning this memorandum should be referred to Mr. William L. Ray, 3-3809.

*John Q. Miller*  
John Q. Miller  
Chief, Solid Motor Branch

cc:  
EA01/Mr. Hardy  
EE01/Dr. Littles  
SA41/Mr. Mulloy  
SA42/Mr. Wear  
SA42/Mr. McIntosh  
EE11/Mr. Coates  
EE11/Mr. Jones  
EP01/Mr. McCool  
EP21/Mr. McCarty  
EP25/Mr. Powers  
EP25/Mr. Ray

PC 026426

V-D

National Aeronautics and  
Space Administration

George C. Marshall Space Flight Center  
Marshall Space Flight Center, Alabama  
35812

Reply to Attn of EP25 (83-119)

December 6, 1983

TO: EE51/Mr. Horton  
FROM: EP25/Mr. Miller  
SUBJECT: Request for Tests by the Contractor to Obtain Space Shuttle SRM Clevis Joint, Fixed Housing/Aft Segment Joint and Igniter Adapter/Forward Segment Joint Leak Check Data

It is requested that you take formal action to assure that the following tests are performed in a timely manner by the contractor, Morton/Thiokol, on SRM Hardware:

a. Case Clevis Joint Dual O-Ring Seal Leak Detection - Perform tests with full scale clevis joint hardware (short joints) to obtain the following data as a minimum:

- (1) Post assembly pressure in the zinc chromate sealant cavity.
- (2) Minimum and maximum volume of the zinc chromate sealant cavity, post assembly.
- (3) Minimum pressure required to effect zinc chromate sealant blow through.
- (4) Bleedback capability of the primary seal (from sealant cavity to cavity between the primary and secondary seals) at a variety of pressure values ranging from 10 psig up to a value which has been determined to effect sealant blowthrough. Various types of primary seal leakage conditions at predetermined leakage rates should be simulated.
- (5) Determine maximum acceptable leakage rates at 200 psig which meets the 50 psig leak test criteria.
- (6) Determine minimum pressure and time required to position O-rings for 50 psig leak check.
- (7) Determine the volume of the cavity between the primary and secondary O-rings by analysis and flow test prior to and following the 200 psi O-ring positioning cycle.
- (8) KSC and MTI GSE volumes should be simulated and the required temperature range should be duplicated as close as possible. Type II zinc chromate sealant should be used for all tests.

D U O R S E 3 1

**25**  
50th Anniversary  
1958-1983

b. Nozzle Fixed Housing/Aft Segment Boss Joint - Perform tests with full scale hardware to accomplish the objectives in item a. above. The test designed to determine O-ring bleedback rate need not be repeated.

c. Igniter Adapter/Case Forward Segment Boss Joint - Perform tests with full scale hardware to accomplish the objectives in item a. above. Tests to determine pressure value required to position the seal is not required.

It is highly desirable to complete these tests prior to stacking of STS-12.

Questions concerning this memorandum should be referred to Mr. Leon Ray, 3-3809.

  
John Q. Miller  
Chief, Solid Motor Branch

cc:  
SA42/Mr. Wear  
SA42/Mr. Denton  
EE11/Mr. Coates  
EP01/Mr. McCool  
EP21/Mr. McCarty  
EP25/Mr. Powers  
EP25/Mr. Ray

PC 026432

V-E

National Aeronautics and  
Space Administration



George C. Marshall Space Flight Center  
Marshall Space Flight Center Alabama  
35812

85-18

EP01 (85-48)

March 7, 1985

TO: SA41/Mr. Mulloy *ll*  
THRU: EE11/Mr. Horton *ll*  
FROM: EP01/Mr. McCool  
SUBJECT: Request for Initiation of Testing to Provide Data for Resolving  
the Burned O-Ring Seal Problem on the Space Shuttle SRM

Letter EP25 (83-119), from Mr. Miller (EP25) to Mr. Horton (EE11), subject: "Request for Tests by the Contractor to Obtain Space Shuttle SRM Clevis Joint, Field Housing/Aft Segment Joint and Ignition Adapter/Forward Segment Joint Leak Check Data" is referenced.

On December 6, 1983, this office requested via the referenced letter that the contractor obtain available full scale diameter, short stack hardware and conduct tests to provide data on zinc chromate putty behavior as related to affect on joint leak checks. Fourteen months have elapsed and no visible action has been taken to obtain and equip the short stack hardware although agreement was made to perform the test at the time of request. The only positive response by the contractor was the submittal of TNR-14359 on May 4, 1983, which contained a program plan followed by 5-inch CP motor tests, which were not designed to provide a solution to the burned O-ring problem. The acquisition of joint putty layup and leak check data on a high priority basis has become very important in view of the need to resolve the burned O-ring problems; accordingly, it is requested that you take the necessary action to direct that the following tasks be expeditiously performed by the contractor:

a. Subscale and full scale tests to determine effects of asbestos filled, cotton and talc filled, and non-filled zinc chromate putty on O-ring sealing integrity.

b. Full scale tests:

- (1) Putty layup tests using current layup design.
- (2) Putty layup tests using the attached figure 1 layup concept.
- (3) Putty layup tests using the attached figure 2 layup concept.

RC 086413

**25**

(4) Repeat tests (1) and (2) except with vent slots located at 120-degree interval around the circumference as shown by attached figures 3 and 4. The slots are designed to prevent air entrapment and resulting volcanoes. Evaluation of layup effectiveness should be performed with flow meters to determine cavity volumes.

The above tasks are intended to complement TWR-14359 rather than replace the tests defined therein. We will be happy to assist the contractor in working out the details for the above proposals.

*A.A. McCool*

A.A. McCool  
Director  
Structures and Propulsion Laboratory

Enclosures:  
As stated

cc:  
SA42/Messrs. McIntosh/Denton  
EE11/Mr. Coates  
EE11/Mr. Jones  
EP21/Mr. McCarty  
EP25/Messrs. Miller/Powers/Ray  
EE01/Dr. Littles

PC 026414

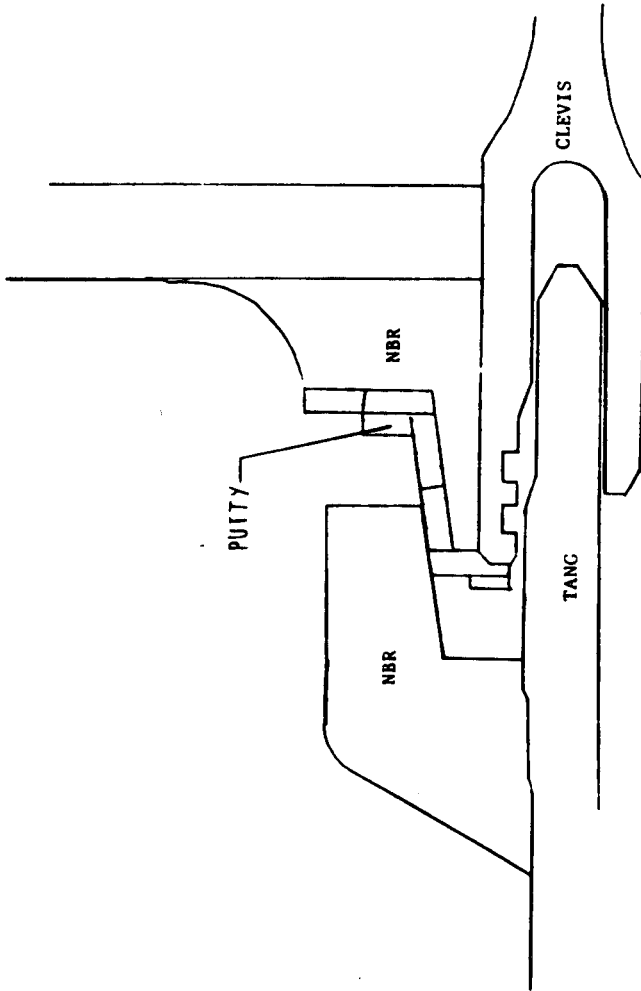

Figure 1

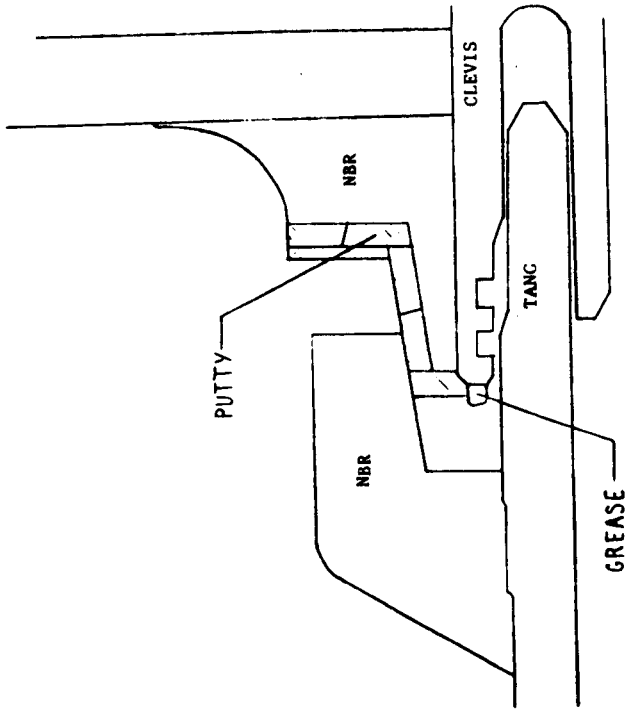

Figure 2



PC 026417

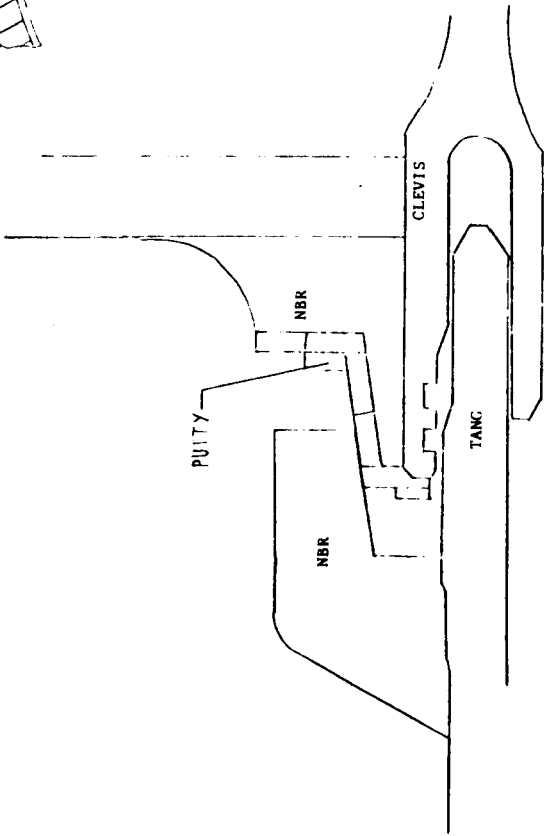
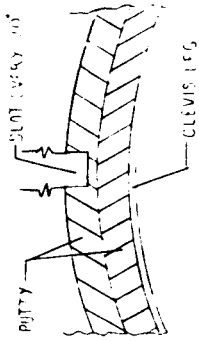

Figure 3

PC 026418

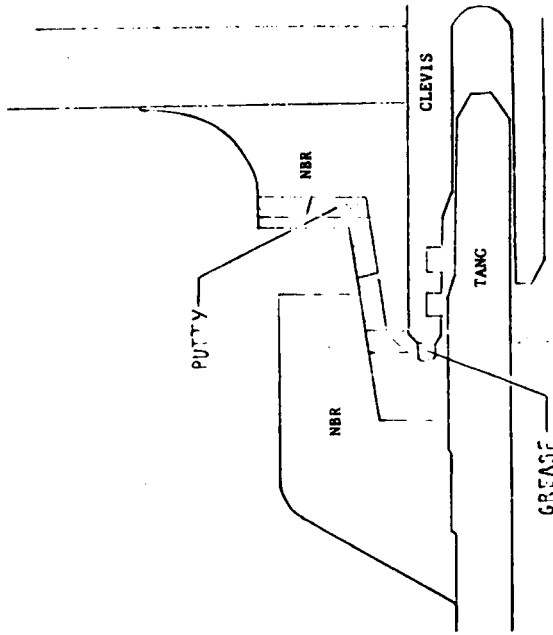
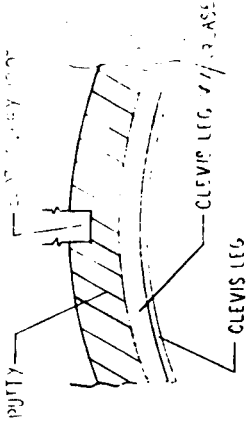

Figure 4

V-F

National Aeronautics and  
Space Administration



George C. Marshall Space Flight Center  
Marshall Space Flight Center Alabama  
35812

Reply to Attn of EP25 (84-15)

February 22, 1984

TO: EE11/Mr. Horton  
FROM: EP25/Mr. Miller  
SUBJECT: Inspection of Fired SRM Pressure Joint During Disassembly

Please take the necessary action to reinstate detail post flight and post static firing inspection of specific pressure joints on the SRM which incorporate the thermal barrier and O-ring seal design concept. The inspection must be conducted at the time of disassembly to preclude destruction of data. The task should be performed by experienced, qualified engineering personnel and should be continued until the burned O-ring problem is understood and resolved.

The incidence of heat damaged O-rings on STS-2, QM-4 and on the recent flight of STS-11 warrants close surveillance of these areas to ensure that suspected anomalies are detected and properly recorded for assessment purposes. Recent discovery that the new type II zinc chromate sealant (thermal barrier material) would not adhere to the nozzle surface to which it was being applied, has opened up several unanswered questions, the most important being adhesion life of the sealant after installation on the SRM. Type II zinc chromate sealant was installed on all SRM's beginning with STS-8.

Areas of concern which warrant inspection are:

- a. SRM case field joints.
- b. SRM case nozzle boss to nozzle fixed housing joint.
- c. SRM igniter to SRM case igniter boss.
- d. Nozzle field splice joint.

*for*   
John Q. Miller  
Chief, Solid Motor Branch

PC 02642A

cc:

EE01/Mr. Hardy  
SA41/Mr. Mulloy  
SA42/Mr. Wear  
SA42/Mr. McIntosh  
EP01/Mr. McCool  
EP21/Mr. McCarty  
EP25/Mr. Powers  
EP25/Mr. Ray

PC 026429

V-G

22 July 1985

PROGRESS REPORTAPPLIED MECHANICS DEPARTMENT  
Cost Center 287xSPACE SHUTTLESRM O-Ring Erosion Problem

This problem has escalated so badly in the eyes of everyone, especially our customer, NASA, that NASA has gone to our competitors on a propriety basis and solicited their experiences on their joint configurations.

This whole week has been spent concepting ideas on how to eliminate the O-ring erosion problem. The new ground rule is to present every idea regardless of impact to cost weight schedule or whatever. Eleven hours of just group meetings has been spent discussing the problem and potential solutions. This does not include the many hours of informal meetings held with smaller groups.

One thing is increasingly obvious as time passes on this problem. If the company and/or Engineering does not assign specific people to this task (with no other work allowed - this being an absolute requirement) to secure a timely solution, then we stand in danger of having one of our competitors solve our problem via an unsolicited proposal. This thought is almost as horrifying as having a flight failure before a solution is implemented to prevent O-ring erosion.

*Regan M. Beigley*  
7/22/85

V-H

**MORTON THIOKOL INC.**

Wasatch Division



## Interoffice Memo

1 October 1985  
E150/RVE-86-47

**TO:** A. J. McDonald, Director  
Solid Rocket Motor Project

**FROM:** Manager, SRM Ignition System, Final Assembly, Special  
Projects and Ground Test

**CC:** B. McDougall, B. Russell, J. McCluskey, D. Cooper,  
J. Kilminster, B. Brinton, T. O'Grady, B. MacBeth,  
J. Sutton, J. Elwell, I. Adams, F. Call, J. Lamere,  
P. Ross, D. Fullmer, E. Bailey, D. Smith, L. Bailey,  
B. Kuchek, Q. Eskelsen, P. Petty, J. McCall

**SUBJECT:** Weekly Activity Report  
1 October 1985

EXECUTIVE SUMMARY

**HELP!** The seal task force is constantly being delayed by every possible means. People are quoting policy and systems without work-around. MSFC is correct in stating that we do not know how to run a development program.

GROUND TEST

1. The two (2) GTM center segments were received at T-24 last week. Optical measurements are being taken. Significant work has to be done to clean up the joints. It should be noted that when necessary SICBM takes priority.
2. The DM-6 test report less composite section was released last week.

ELECTRICAL

As a result of the latest engineering analysis of the V-1 case it appears that high stress risers to the case are created by the phenolic DFI housings and fairings. As it presently stands, these will probably have to be modified or removed and if removed will have to be replaced. This could have an impact on the launch schedule.

PC 102554

A. J. McDonald, Director  
 1 October 1985  
 E150/RVE-86-47  
 Page 2

#### FINAL ASSEMBLY

One SRM 25 and two SRM 26 segments along with two SRM 24 exit cones were completed during this period. Only three segments are presently in work. Availability of igniter components, nozzles and systems tunnel tooling are the present constraining factors in the final assembly area.

#### IGNITION SYSTEM

1. Engineering is currently rewriting igniter gask-o-seal coating requirements to allow minor flaws and scratches. Bare metal areas will be coated with a thin film of HD-2 grease. Approval is expected within the week.
2. Safe and Arm Device component deliveries is beginning to cause concern. There are five S&A's at KSC on the shelf. Procurement, Program Office representatives visited Consolidated Controls to discuss accelerating scheduled deliveries. CCC has promised 10 A&M's and 30 B-B's no later than 31 October 1985.

#### O-RINGS AND PUTTY

1. The short stack finally went together after repeated attempts, but one of the o-rings was cut. Efforts to separate the joint were stopped because some do not think they will work. Engineering is designing tools to separate the pieces. The prints should be released tomorrow.
2. The inert segments are at T-24 and are undergoing inspection.
3. The hot flow test rig is in design, which is proving to be difficult. Engineering is planning release of these prints Wednesday or Thursday.
4. Various potential filler materials are on order such as carbon, graphite, quartz, and silica fiber braids; and different putties. They will all be tried in hot flow tests and full scale assembly tests.
5. The allegiance to the o-ring investigation task force is very limited to a group of engineers numbering 8-10. Our assigned people in manufacturing and quality have the desire, but are encumbered with other significant work. Others in manufacturing, quality, procurement who are not involved directly, but whose help we need, are generating plenty of resistance. We are creating more instructional paper than engineering data. We wish we could get action by verbal request but such is not the case. This is a red flag.



R. V. Ebeling

OCT 1985

V-I

National Aeronautics and  
Space Administration

George C. Marshall Space Flight Center  
Marshall Space Flight Center, Alabama  
35812

Reply to AAM of: EP25 (79-23)

February 6, 1979

TO: Distribution

FROM: EP25/Mr. Ray

SUBJECT: Visit to Precision Rubber Products Corporation and  
Parker Seal Company

The purpose of this memorandum is to document the results of a visit to Precision Rubber Products Corporation, Lebanon, TN, by Mr. Eudy, EE51 and Mr. Ray, EP25, on February 1, 1979 and also to inform you of the visit made to Parker Seal Company, Lexington, KY on February 2, 1979 by Mr. Ray. The purpose of the visits was to present the O-ring seal manufacturers with data concerning the large O-ring extrusion gaps being experienced on the Space Shuttle Solid Rocket Motor clevis joints and to seek opinions regarding potential risks involved.

The visit on February 1, 1979, to Precision Rubber Products Corporation by Mr. Eudy and Mr. Ray was very well received. Company officials, Mr. Howard Gillette, Vice President for Technical Direction, Mr. John Hoover, Vice President for Engineering, and Mr. Gene Hale, Design Engineer attended the meeting and were presented with the SRM clevis joint seal test data by Mr. Eudy and Mr. Ray. After considerable discussion, company representatives declined to make immediate recommendations because of the need for more time to study the data. They did, however, voice concern for the design, stating that the SRM O-ring extrusion gap was larger than that covered by their experience. They also stated that more tests should be performed with the present design. Mr. Hoover promised to contact MSFC for further discussions within a few days. Mr. Gillette provided Mr. Eudy and Mr. Ray with the names of two consultants who may be able to help. We are indebted to the Precision Rubber Products Corporation for the time and effort being expended by their people in support of this problem, especially since they have no connection with the project.

The visit to the Parker Seal Company on February 2, 1979, by Mr. Ray, EP25, was also well received; Parker Seal Company supplies the O-rings used in the SRM clevis joint design. Parker representatives, Mr. Bill Collins, Vice President for Sales, Mr. W. B. Green, Manager for Technical Services, Mr. J. W. Kosty, Chief Development Engineer for R&D, Mr. D. P. Thalman, Territory Manager and Mr. Dutch Haddock, Technical Services, met with Mr. Ray, EP25, and were provided with the identical

PC 028477



SRM clevis joint data as was presented to the Precision Rubber Products Company on February 1, 1979. Reaction to the data by Parker officials was essentially the same as that by Precision; the SRM O-ring extrusion gap is larger than they have previously experienced. They also expressed surprise that the seal had performed so well in the present application. Parker experts would make no official statements concerning reliability and potential risk factors associated with the present design; however, their first thought was that the O-ring was being asked to perform beyond its intended design and that a different type of seal should be considered. The need for additional testing of the present design was also discussed and it was agreed that tests which more closely simulate actual conditions should be done. Parker officials will study the data in more detail with other Company experts and contact MSFC for further discussions in approximately one week. Parker Seal has shown a serious interest in assisting MSFC with this problem and their efforts are very much appreciated.

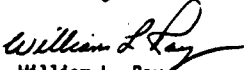

William L. Ray  
Solid Motor Branch, EP25

Distribution:  
SA41/Messrs. Hardy/Rice  
EE51/Mr. Eudy  
EP01/Mr. McCool

PC 02647B

V-J

COMPANY PRIVATE

## MORTON THIOKOL INC.

Wasatch Division



Interoffice Memo

31 July 1985  
2870:FY86-073

TO: R. K. Lund  
Vice President, Engineering

CC: B. C. Brinton, A. J. McDonald, L. H. Sayer, J. R. Kapp

FROM: R. M. Boisjoly  
Applied Mechanics - Ext. 3525

SUBJECT: SRM O-Ring Erosion/Potential Failure Criticality

This letter is written to insure that management is fully aware of the seriousness of the current O-Ring erosion problem in the SRM joints from an engineering standpoint.

The mistakenly accepted position on the joint problem was to fly without fear of failure and to run a series of design evaluations which would ultimately lead to a solution or at least a significant reduction of the erosion problem. This position is now drastically changed as a result of the SRM 16A nozzle joint erosion which eroded a secondary O-Ring with the primary O-Ring never sealing.

If the same scenario should occur in a field joint (and it could), then it is a jump ball as to the success or failure of the joint because the secondary O-Ring cannot respond to the clevis opening rate and may not be capable of pressurization. The result would be a catastrophe of the highest order - loss of human life.

An unofficial team (a memo defining the team and its purpose was never published) with leader was formed on 19 July 1985 and was tasked with solving the problem for both the short and long term. This unofficial team is essentially nonexistent at this time. In my opinion, the team must be officially given the responsibility and the authority to execute the work that needs to be done on a non-interference basis (full time assignment until completed).

COMPANY PRIVATE

PC 102534

A. A. LUNG

- 2 -

31 July 1983

It is my honest and very real fear that if we do not take immediate action to dedicate a team to solve the problem, with the field joint having the number one priority, then we stand in jeopardy of losing a flight along with all the launch pad facilities.

*R. M. Boisjoly*

R. M. Boisjoly

Concurred by:

*Jack E. Kapp*

J. E. Kapp, Manager  
Applied Mechanics

COMPANY PRIVATE

PC 102537

NATURAL/INDUCED ENVIRONMENT  
REQUIREMENTS

292

VI-A

R. H. KOHRS  
MAY 19, 1986

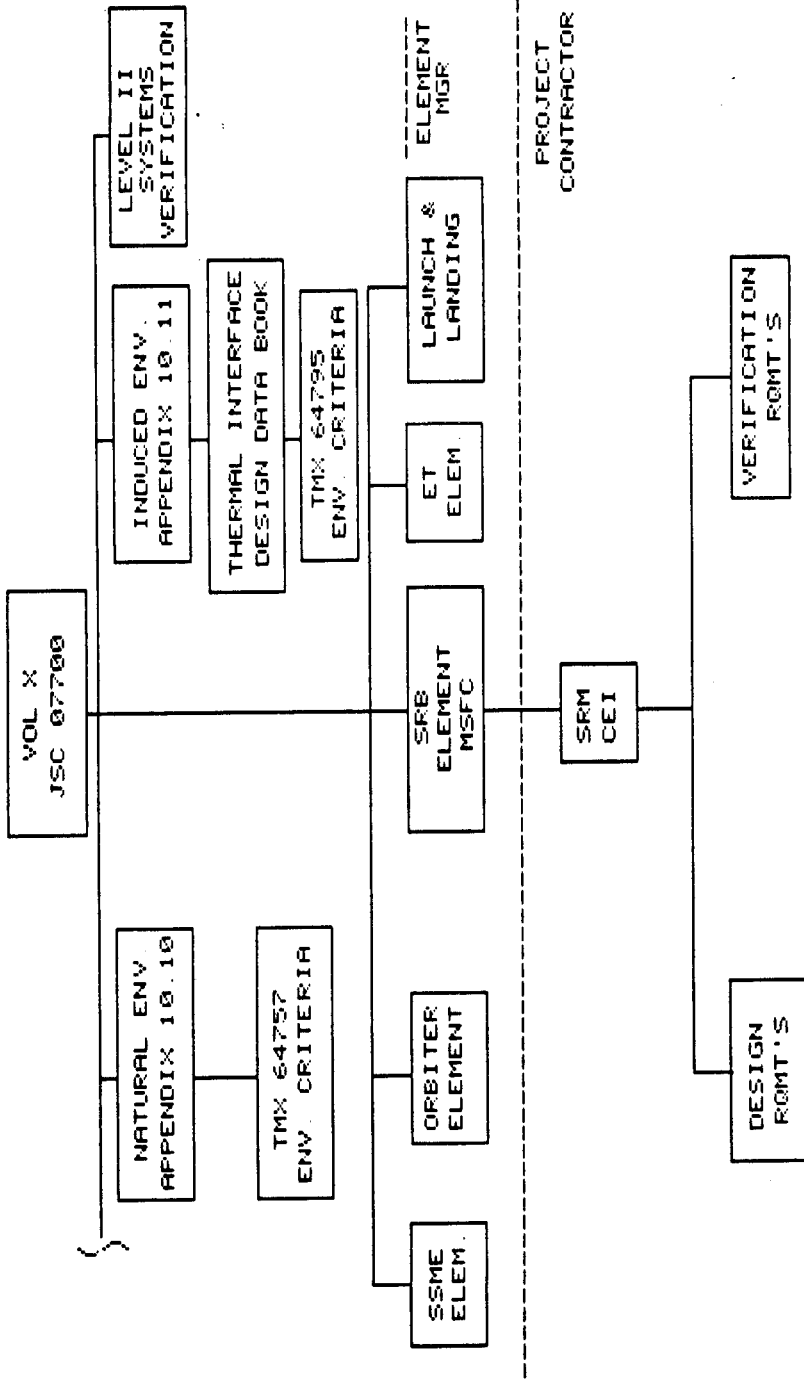

VOLX.SKE



—————→ JSC 07700  
—————→ VOLUME X  
REVISION D

---

Lyndon B. Johnson Space Center  
Houston, Texas 77058

**NATIONAL  
SPACE TRANSPORTATION SYSTEMS  
PROGRAM**

**SPACE SHUTTLE FLIGHT AND GROUND SYSTEM  
SPECIFICATION**

**LEVEL II PROGRAM DEFINITION  
AND REQUIREMENTS**

**SEPTEMBER 30, 1983**

②

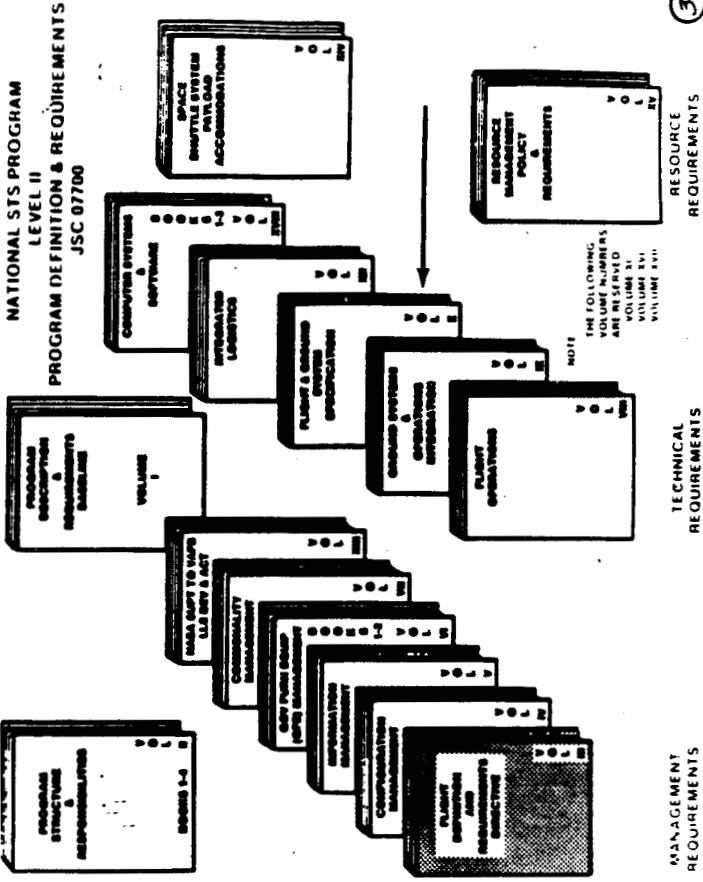

shall not exceed 0.5 psig maximum at a boil-off rate of 2.9 lb/sec. The  $H_2$  vent system shall not interface with the Orbiter but shall vent directly to atmosphere in flight. In addition to providing BT relief protection, the vent valves shall be capable of being actuated open, prior to launch, by ground command. The electrical command and pneumatic supply will be provided by GSE. Capability shall be provided to scavenge the main propulsion  $LN_2$  system pressure when vehicle or ground power is not applied to the flight instruments.

3.2.2.1.16 IG Compatibility. Any material used internally in the liquid oxygen system of the Space Shuttle System main propulsion subsystems shall be compatible as determined by NBS 8060.1.

3.2.2.1.17 Design Environments.

→ 3.2.2.1.17.1 Natural Environment. The Shuttle Flight Vehicle design shall satisfy the natural environment design requirements specified in Appendix 10.10.

→ 3.2.2.1.17.2 Induced Environment. Each element of the Shuttle Flight Vehicle shall be capable of withstanding the induced environments imposed during transportation, ground operations, handling and flight operations as defined in Appendix 10.11. Each interface between elements shall be designed to withstand the induced environments defined in the applicable ICD.

3.2.2.1.17.2.1 Ascent Heating Design Criteria. In general, all elements of the Space Shuttle System shall be designed to withstand limiting induced ascent aerodynamic and plume heating environments, encompassing all baseline reference missions. The Orbiter vehicle for which limit ascent aerodynamic heating environments coupled with reuse criteria would result in unnecessary weight and cost penalties, shall be designed to meet reuse requirements considering the frequency of occurrence of the ascent heating environments resulting from statistical treatment of the baseline reference missions and shall be shown to have single-mission survivability for limit ascent aerodynamic heating case encountered on any mission during the lifetime of the vehicle. The applicable environments are defined in Appendix 10.11.

3.2.2.1.17.3 IFS Absorption. All IFS material and installation design shall minimize absorption and entrapment of liquids or gases which would degrade thermal or physical performance or present a fire hazard (wicking), and shall not require draining, drying or any dedicated purge system from refurbishment through launch.

83 3.2.2.1.18 Flow Induced Vibration. All flexible hoses and bellows shall be designed to exclude or minimize flow induced

83 Refer to the Deviation/Waiver Page in front of the document.



8.0 METEOROID. The Space Shuttle shall be designed to sustain a 0.95 probability of no penetration during the maximum total time for 500 missions in orbit, using the meteoroid model defined in Section 2.5.1 of TX-64627.

8.1 METEOROID IMPACT. Space Shuttle meteoroid impact requirements shall be specified below:

- A. Pressure Loss. The Space Shuttle manned volume shall be protected from meteoroid impact damage which would result in pressure loss when subjected to the meteoroid flux model as defined in TX-64627.
- B. Functional Capability. The Space Shuttle shall provide protection against loss of functional capability of selected critical items when subjected to the meteoroid flux model as defined in TX-64627. The probability of no penetration shall be assessed on each item dependent upon function criticality.

9.0 ASTRODYNAMIC CONSTANTS. The values given in Sections 1.6 and 2.7 of TX-64627 shall be used.

#### 10.0 THERMAL.

10.1 GROUND THERMAL ENVIRONMENT. The ground thermal environment, including air temperature, solar radiation, and sky temperature limits, are specified in Table 10.1-1 and Figure 10-1. Also, see Sections 2.5 and 2.6 of TX-64757.

10.1.1 Ambient Temperature for SBE Propellant Temperature Predictions. The appropriate ISC and VAPS monthly mean and extreme ambient temperatures listed below shall be used to establish SBE propellant temperatures and thrust performance. The low and high extremes are the 2.5 and 97.5 percentile average monthly temperatures.

# NASA TECHNICAL MEMORANDUM

NASA TM X-64757 ←

## TERRESTRIAL ENVIRONMENT (CLIMATIC) CRITERIA GUIDELINES FOR USE IN AEROSPACE VEHICLE DEVELOPMENT, 1973 REVISION

Glenn E. Daniels, Editor  
Aero-Astroynamics Laboratory

July 5, 1973

**NASA**

*George C. Marshall Space Flight Center  
Marshall Space Flight Center, Alabama*

⑥

Table 10.1-1  
Ground Thermal Environment

Thermal Environment Factor	Ferry Sites		Vertical Flight
	Air Temperature (Degrees F) Design High	103	
Low	20		31 ←
Solar Radiation (Btu/ft <sup>2</sup> -hr) Design High	See Figure 10-1		
Low (Diffuse)			
Sky Temperature (Degrees F) Design High	50		
Low	-22		5

Local Standard Time - Hour

Time of Day	Design High Solar Radiation		Design Low Solar Radiation	
	Btu/ft <sup>2</sup> /hr	gm-cal/cm <sup>2</sup> /min	Btu/ft <sup>2</sup> /hr	gm-cal/cm <sup>2</sup> /min
0500	0	0.00	0	0.00
1100	363	1.64	70	0.32
1300			80	0.36
1400	363	1.64		
2000	0	0.00	0	0.00

⑦

### 2. 5. 3. 4 Solar Radiation during Extreme Conditions

When ground winds occur exceeding the 95, 99, or 99.9 percentile design winds given in this document in Section V, the associated weather normally is such that clouds, rain, or dust are generally present; therefore, the intensity of the incoming solar radiation will be less than the maximum values given in Tables 2. 3 and 2. 4. Maximum values of solar radiation intensity to use with corresponding wind speeds are given in Table 2. 5.

**TABLE 2. 5 SOLAR RADIATION MAXIMUM VALUES ASSOCIATED WITH EXTREME WIND VALUES**

Maximum Solar Radiation (Normal Incidence)						
Steady-State Ground Wind Speed at 10 m Height	Memphis, New Orleans River Transportation, Gulf Transportation, Eastern Test Range, Western Test Range, Sacramento, West Coast Transportation and Wallops Test Range			White Sands Missile Range		
	( $m\ sec^{-1}$ )	( $kWhr^{-2}\ sec^{-1}$ )	( $g-cal\ cm^{-2}\ min^{-1}$ )	( $BTU\ ft^{-2}\ hr^{-1}$ )	( $kWhr^{-2}\ sec^{-1}$ )	( $g-cal\ cm^{-2}\ min^{-1}$ )
10	0.94	1.39	305	1.05	1.59	338
15	0.88	0.99	177	0.79	1.09	231
20	0.78	0.69	111	0.58	0.89	177

### 2. 6 Temperature ←

Several types of temperatures at the earth's boundary layer may be considered in design. These are as follows:

- a. Air temperature normally measured at 1.23 meters (4 ft) above a grass surface.
- b. Changes of air temperature (Usually the rapid changes which occur in less than 24 hours are considered.)
- c. Surface or skin temperature measured of a surface exposed to radiation.
- d. Temperatures within a closed compartment.

All of the above will be discussed in the following subsections.

### 2.6.1 Air Temperature Near the Surface

Surface air temperature extremes (maximum, minimum, and the 95 percentile values) and the extreme minimum sky radiation (equal to the outgoing radiation) are given in Table 2.6 for various geographical areas. Maximum and minimum temperature values should be expected to last only a few hours during a daily period. Generally, the maximum temperature is reached after 12 noon and before 5 p. m., while the minimum temperature is reached just before sunrise. Table 2.7A shows the maximum and minimum air temperatures which have occurred on each hour at Kennedy Space Center, but not necessarily on the same day, although these curves represent a cold and hot extreme day. The method of sampling the day (frequency of occurrence of observations) will result in the same extreme values if the same period of time for the data is used, but the 95 percentile values will be different for hourly, daily, and monthly data reference periods. Selection of the reference period depends on engineering application. Table 2.7B gives month mean temperatures, standard deviations and 2.5 and 97.5 percentiles of values of temperature for Kennedy Space Center, Florida and Vandenberg AFB, California.

### 2.6.2 Extreme Air Temperature Change

a. For all areas the design values of extreme air temperature changes (thermal shock) are:

(1) An increase of air temperature of  $10^{\circ}\text{C}$  ( $18^{\circ}\text{F}$ ) with a simultaneous increase of solar radiation (measured on a normal surface) from  $0.50 \text{ g-cal cm}^{-2} \text{ min}^{-1}$  ( $110 \text{ BTU ft}^{-2} \text{ hr}^{-1}$ ) to  $1.65 \text{ g-cal cm}^{-2} \text{ min}^{-1}$  ( $410 \text{ BTU ft}^{-2} \text{ hr}^{-1}$ ) may occur in a 1-hour period. Likewise, the reverse change of the same magnitude may occur for decreasing air temperature and solar radiation.

(2) A 24-hour change may occur with an increase of  $27.7^{\circ}\text{C}$  ( $50^{\circ}\text{F}$ ) in air temperature in a 8-hour period, followed by 4 hours of constant air temperature, then a decrease of  $27.7^{\circ}\text{C}$  ( $50^{\circ}\text{F}$ ) in a 8-hour period, followed by 10 hours of constant air temperature.

b. For Eastern Test Range (Kennedy Space Center), the 99.9 percentile air temperature changes are as follows:

(1) An increase of air temperature of  $5.6^{\circ}\text{C}$  ( $11^{\circ}\text{F}$ ) with a simultaneous increase of solar radiation (measured on a normal surface) from  $0.50 \text{ g-cal cm}^{-2} \text{ min}^{-1}$  ( $110 \text{ BTU ft}^{-2} \text{ hr}^{-1}$ ) to  $1.60 \text{ g-cal cm}^{-2} \text{ min}^{-1}$  ( $354 \text{ BTU ft}^{-2} \text{ hr}^{-1}$ ), or a decrease of air temperature of  $9.4^{\circ}\text{C}$  ( $17^{\circ}\text{F}$ ) with a simultaneous decrease of solar radiation from  $1.60 \text{ g-cal cm}^{-2} \text{ min}^{-1}$  ( $354 \text{ BTU ft}^{-2} \text{ hr}^{-1}$ ) to  $0.50 \text{ g-cal cm}^{-2} \text{ min}^{-1}$  ( $110 \text{ BTU ft}^{-2} \text{ hr}^{-1}$ ) may occur in a 1-hour period. ②

2.40

**TABLE 2.7 MAXIMUM AND MINIMUM SURFACE AIR TEMPERATURES  
AT EACH HOUR FOR EASTERN TEST RANGE<sup>4</sup>**

Time	Annual Maximum		Annual Minimum	
	°C	°F	°C	°F
1 a.m.	28.9	84	1.1	34
2	28.9	84	0.6	33
3	29.4	85	-1.1	30
4	28.3	83	-0.6	29
5	28.3	83	-1.1	29
6	29.4	85	-1.1	27
7	30.6	87	-1.7	26
8	30.6	87	-2.2	25
9	31.7	89	-0.6	28
10	33.0	93	1.1	30
11	35.0	95	2.2	35
12 noon	35.6	96	5.0	41
1 p.m.	37.2	99	5.6	42
2	35.6	97	5.0	41
3	35.6	97	5.6	42
4	35.6	97	5.6	42
5	35.6	97	5.6	42
6	35.0	95	2.9	39
7	33.3	92	2.2	36
8	31.7	89	2.2	36
9	30.0	86	1.7	35
10	30.0	86	1.7	35
11	30.0	86	1.1	34
12 mid	30.0	86	1.1	34

4. Based on 10 years of record for Patrick Air Force Base and Kennedy Space Center.

(10)

2.0 APPLICABLE DOCUMENTS. The below listed documents form a part of this appendix to the extent specified herein. These documents shall be individually approved as baseline requirements. The "Current Issue" of each document may be determined from JSC 08102, Space Shuttle Program Level II Baseline Description and Status Report.

Contractor Handbooks

SD73-SH-0069-1 (Current Issue)	Structural Design Loads Data Book, Baseline Vehicle and Missions  Ref. Para. 3.3, 3.3.1, Table 10.11.1
SD73-SH-0069-2 (Current Issue)	Orbiter Structural Design Loads Data Book  Ref. Para. 3.3, 3.3.2, Table 10.11.1
SD73-SH-0069-3 (Current Issue)	Structural Design Loads Data Book, External Tank  Ref. Para. 3.3, 3.3.3, Table 10.11.1
SD73-SH-0069-4 (Current Issue)	Structural Design Loads Data Book, Solid Rocket Boosters Structural Loads  Ref. Para. 3.3, 3.3.4, Table 10.11.1
SD73-SH-0181-1 (Current Issue)	Aerodynamic Heating Data Book, Orbiter - Ascent (Books I, II and III)  Ref. Para. 3.1, 3.1.1, Table 10.11.1
SD73-SH-0181-2 (Current Issue)	Aerodynamic Heating Data Book External Tank - Ascent (Books I and II)  Ref. Para. 3.1, 3.1.1, Table 10.11.1
SD73-SH-0181-3 (Current Issue)	Aerodynamic Heating Data Book, Shuttle Vehicle Booster - Ascent (Books I and II)  Ref. Para. 3.1, 3.1.1, Table 10.11.1

SD73-SH-0181-4  
(Current Issue)

Aerodynamic Heating Data Book, Space Shuttle Main Engine

Ref. Para. 3.1, 3.1.1, Table 10.11.1

SD73-SH-0181-5  
(Current Issue)

Aerodynamic Heating Data Book, Shuttle Launch Facility

Ref. Para. 3.1, 3.1.1, Table 10.11.1

SD73-SH-0181-7  
(Current Issue)

Aerodynamic Heating Data Book, Lightweight External Tank-Ascent

Ref. Para. 3.1

SD74-SH-0082  
(Current Issue)

Acoustics and Shock Data Book, Space Shuttle System

Ref. Para. 3.4, 3.5, Table 10.11.1

SD74-SH-0144  
(Current Issue)

Thermal Interfaces Design Data Book ←

Ref. Para. 3.2, Table 10.11.1



SD 74-SH-0144D

SPACE SHUTTLE PROGRAM  
THERMAL INTERFACES DESIGN DATA BOOK

DECEMBER 1977

SDM BASELINE

Contract NAS9-14000  
IRD No. SE-699T2  
WBS 2.2.1

Prepared by

*W. G. Casey*

W.G. Casey, Supervisor  
RCC and Penetrations Analysis

*C. A. Laran*

C.A. Laran  
RCC and Penetrations Analysis

Approved by

*P. C. Marhoff*

P.C. Marhoff, Manager  
Thermal Analysis

*N. F. Witté*

N.F. Witté, Director  
Shuttle Aero Sciences



Rockwell International  
Space Division

13



## 1.0 INTRODUCTION

## 1.1 SCOPE

Contained herein are the thermal design data required to complete the thermal interface definitions for the following interface control documents (ICD's):

ICD 2-12001	Orbiter Vehicle/External Tank
ICD 2-14001	Orbiter Vehicle/Solid Rocket Booster
ICD 2-24001	External Tank/Solid Rocket Booster
ICD 13M-13000	Space Shuttle Orbiter Vehicle/Main Engine

## 1.2 APPLICABLE DOCUMENTS

The natural environments that have an effect on the thermal design are defined in the following documents:

JSC 07700, Space Shuttle Flight and Ground Systems Specification, Volume X, Appendix 10.10, Natural Environment Design Requirements. ←

NASA TM X-64795, Distribution of Eight Meteorological Variables at Cape Kennedy, Florida, and Vandenberg Air Force Base, California; Marshall Space Flight Center (dated November 19, 1973). ←

The induced environments applicable to the Shuttle system elements performing as part of the integrated flight vehicle are defined in the following data books:

SD 73-SH-0181-1A, Space Shuttle Aerodynamic Heating Data Book-Orbiter Ascent, Volume I (dated February 1975)

SD 73-SH-0181-2, Space Shuttle Aerodynamic Heating Data Book-External Tank Ascent, Volume II (dated June 1976).

SD 73-SH-0183-3, Space Shuttle Aerodynamic Heating Data Book-Shuttle Vehicle Booster Ascent, Volume III (dated September 1976).

SD 73-SH-0181-4, Space Shuttle Aerodynamic Heating Data Book-Space Shuttle Main Engine Ascent, On-Orbit and Entry, Volume IV (dated September 1977)

These books form part of the Space Shuttle Flight and Ground Systems Specification, JSC 07700, Volume X, Appendix 10.11, Induced Environment Design Requirements. The induced environments data are available on magnetic tape records as specified in Reference 1 for the orbiter, Reference 2 for the external tank, and Reference 3 for the Shuttle vehicle booster.

(14)

## 2.4 SURFACE TEMPERATURE RESPONSES

Surface temperature responses are provided to establish the radiant sources and sinks for the Shuttle vehicle from prelaunch through ascent. These data are not to be construed as material temperature limits. They are intended as thermal interface data required for element thermal design analysis.

### 2.4.1 Prelaunch ←

The prelaunch, post-fill surface temperature histories are presented herein for the hot and cold day environments specified in the Space Shuttle Flight and Ground Systems Specification, JSC 07700, Volume X, Appendix 10.10, Natural Environment Design Requirements. The 95th percentile day for July at Cape Kennedy was used for the extreme hot day environment. For the extreme cold day environment, the 5th percentile day for January at Vandenberg Air Force Base was used. External tank fill was assumed at 1100 hours for all cases.

#### 2.4.1.1 Orbiter Vehicle

The prelaunch environmental temperatures for the fuselage lower external surfaces (Zones O1 through O5, Figure 2.1-1) are presented in Figures 2.4.1.1-1 through 2.4.1.1-4. For the wing leading edge (Zones O6 through O9, Figure 2.1-1), the external surface temperature histories for prelaunch are given in Figures 2.4.1.1-5 and 2.4.1.1-6. The temperature variations for the wing lower external surfaces (Zones O10 through O12, Figure 2.1-1) during prelaunch are provided in Figures 2.4.1.1-7 through 2.4.1.1-9.

#### 2.4.1.2 External Tank (ET)

Figures 2.4.1.2-1 through 2.4.1.2-3 provide the temperature response of the external tank surfaces defined in Figure 2.1-2 when subjected to a hot day prelaunch environment. The cold day prelaunch environment temperature variations for the external tank surfaces (Figure 2.1-2) are presented in Figures 2.4.1.2-4 through 2.4.1.2-6. The temperatures to be used for the ET crossbeam surfaces (Figure 2.1-3) are 98°F for hot day and 29°F for cold day prelaunch environments.

#### 2.4.1.3 Solid Rocket Booster (SRB)

Temperature profiles for the SRB external surfaces defined in Figure 2.1-4 are provided in Figure 2.4.1.3-1 for the hot day prelaunch environment and Figure 2.4.1.3-2 for the cold day prelaunch environment.

#### 2.4.1.4 Space Shuttle Main Engine (SSME)

Hot day prelaunch environmental temperature histories for the Space Shuttle main engine interface envelope, defined in Figure 2.4.1.4-3, are presented in Figure 2.4.1.4-1. The SSME compartment surface temperatures are given in Figure 2.4.1.4-2 for a cold day prelaunch environment.

**NASA TECHNICAL  
MEMORANDUM**

**NASA TM X-64795** ←

**DISTRIBUTIONS OF EIGHT METEOROLOGICAL  
VARIABLES AT CAPE KENNEDY, FLORIDA  
AND VANDENBERG AIR FORCE BASE,  
CALIFORNIA**

**By M. E. Graves, R. L. King, and S. Clark Brown  
Aero-Astrodynamic Laboratory**

**November 19, 1973**

**NASA**

*George C. Marshall Space Flight Center  
Marshall Space Flight Center, Alabama*

17

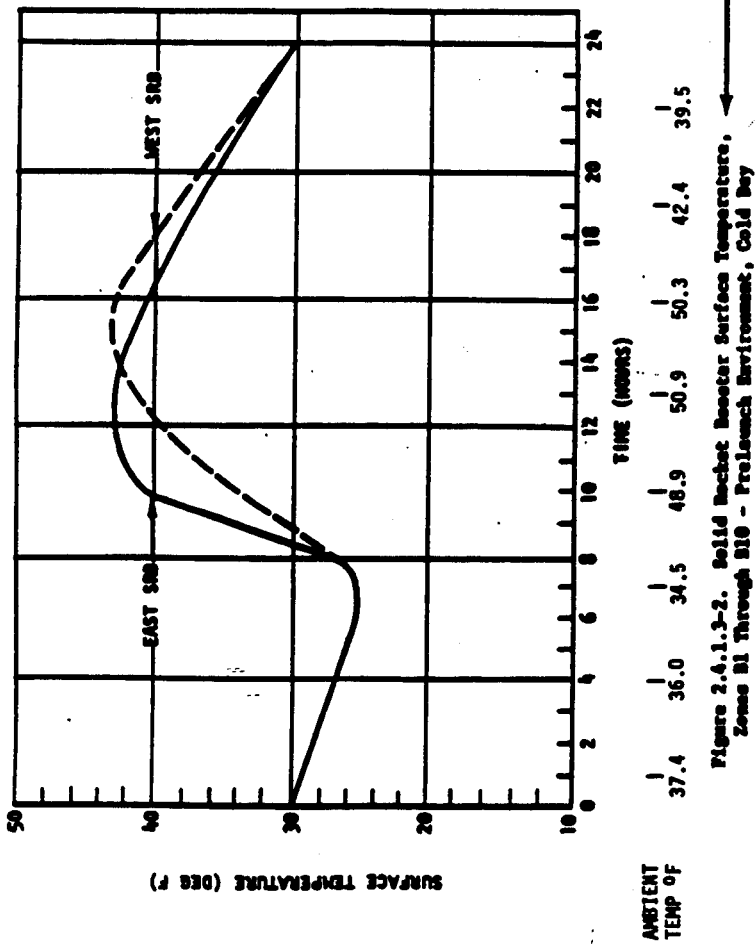

Figure 2.4.1.3-2. Solid Rocket Booster Surface Temperature, Zones B1 Through B10 - Prelaunch Environment, Cold Bay

\*ET FILL COMPLETE AT 1100 HRS

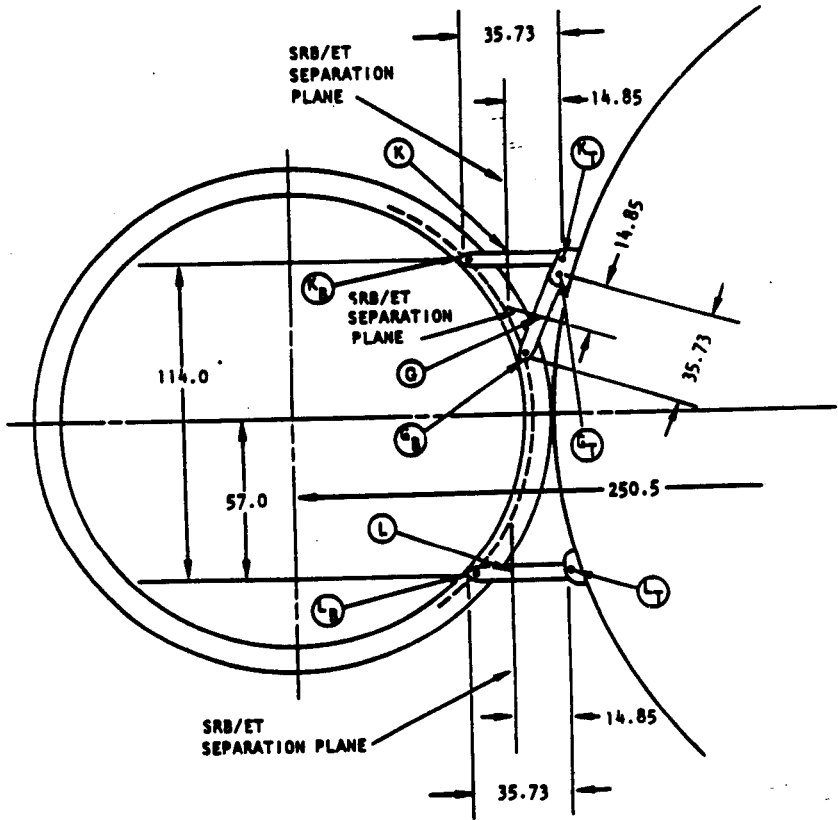

Figure 3.1.2-4. ET/SRB Aft Attachment



### 3.2.3 Solid Rocket Booster

Temperature extremes for the SRB side of the following conduction interfaces:

ET/SRB forward attachment (Figure 3.1.2-3)

ET/SRB aft attachment (Figure 3.1.2-4)

are presented in Table 3.2.3-1 for hot day (maximum) and cold day (minimum).

Table 3.2.3-1. Solid Rocket Booster/External Tank Conduction Interface Temperatures--Prelaunch Environment

Location	Temperature (deg F)	
	Hot Day (maximum)	Cold Day (minimum)
Forward attachment, Location F <sub>3</sub>	89	39
Forward attachment, Location F	90	26
Aft attachment, Locations G <sub>3</sub> , K <sub>3</sub> , and L <sub>3</sub>	96	21 ←

### 3.2.4 Space Shuttle Main Engine

Temperature histories for the SSME side of the following interfaces:

LFFTF flange (Figure 3.1.1-3)

LPOTF flange (Figure 3.1.1-4)

Gimbal bearing (Figure 3.1.1-5)

Heat shield attachment (Figure 3.1.1-6)

TVC actuator attachment (Figure 3.1.1-7)

are presented in Figures 3.2.4-1 through 3.2.4-5.

### 3.2.5 Mobile Launch Platform

Maximum temperatures for the MLP side of the following condition interfaces:

SRB/MLP hold-down support hardware (Figure 3.1.3-1)

are presented in Table 3.2.5-1

Specification No. CPW1-3300

PRIME EQUIPMENT CONTRACT END ITEM  
DETAIL SPECIFICATION  
PART I OF TWO PARTS

→ PERFORMANCE, DESIGN AND VERIFICATION REQUIREMENTS  
SPACE SHUTTLE HIGH PERFORMANCE, SOLID  
ROCKET MOTOR LIGHTWEIGHT  
CPW1-3300  
FOR  
SPACE SHUTTLE SOLID  
ROCKET MOTOR PROJECT  
OPERATIONAL FLIGHT  
(STS-8, 12 & Subs)

17 February 1984

PENDING NASA APPROVAL

DR NO. 2-2

PREPARED FOR

NATIONAL AERONAUTICS AND SPACE ADMINISTRATION  
GEORGE C. MARSHALL SPACE FLIGHT CENTER  
MARSHALL SPACE FLIGHT CENTER, ALABAMA 35812

BY

Morton Thiokol, Inc.  
Wasatch Division  
P.O. Box 524, Brigham City, Utah 84302 801/863-3511





maintenance and refurbishment operations.

3.2.6.3 Personnel Safety. Provisions for personnel safety shall be in accordance with the following:

- a. Safety Devices. Known hazards which cannot be eliminated through design selection shall be reduced to an acceptable level through the use of appropriate safety devices as part of the system, subsystem, or equipment.
- b. Warning Devices. Where it is not possible to preclude the existence or occurrence of a known hazard, devices shall be employed for the timely detection of the condition and the generation of an adequate warning signal. Warning signals and their application shall be designed to minimize the probability of wrong signals or of improper personnel reaction to the signal.

3.2.6.4 Explosive and/or Ordnance Safety. The propellants for the HPML and the igniter shall meet the requirements of hazard classification 2 as defined in the Army Material Command Regulation Safety Manual AMCR 385-100, or DoD Contractor's Safety Manual for Ammunition, Explosives, and Related Dangerous Materials, DoD 4145.26. The HPML segments and ignition system less initiators shall have a DoT explosive classification of Class B.

### 3.2.7 Environment.

3.2.7.1 Natural Environment. The HPML shall withstand the natural environments defined in JSC 07700, Volume X, Appendix 10.10 and the air and sea temperature environments and salinity of SE-019-043-2H. ←

3.2.7.2 Induced Environment. The HPML shall withstand the induced environmental conditions as defined in the following documents: ←

#### Thermal

Base Heating - SD73-SH-0181-3  
 Launch & Ascent - SD73-SH-0181-3  
 Re-entry - SE-019-053-2H  
 Interface - SD74-SH-0144, ICD 3-44003

#### Loads

Vibration, Acoustic & Shock SE-019-049-2H and SE-019-067-2H (as changed by approved Deviation RDW-0012R4) In case of conflict, SE-019-049-2H shall take precedence over SE-019-067-2H.  
 Pre-launch through Separation - SE-019-057-2H, Book 1 (2)

TABLE V

VERIFICATION CROSS REFERENCE INDEX		CPW1-3300 Dated 17 February 1984 Page I-92						
REQUIREMENTS FOR VERIFICATION								
VERIFICATION METHOD:				VERIFICATION PHASE:				
1. Similarity				A. Development				
2. Analysis				B. Qualification				
3. Inspection				C. Acceptance				
4. Demonstration				D. Preflight				
5. Test				E. Flight				
N/A - Not Applicable				F. Postflight				
Section 3.0 Performance/ Design Requirement Reference	Verification Methods						Section 4.0 Verification Requirement Reference	
	N/A	A	B	C	D	E		F
3.2.6.3 Personnel Safety		2	2					4.2.1.2, 4.2.2.2
3.2.6.4 Explosive and/or Ordnance Safety		5	5					4.2.1.5, 4.2.2.5
3.2.7 Environment	X							
3.2.7.1 Natural Environment		2	2					4.2.1.2, 4.2.2.2, ←
3.2.7.2 Induced Environment		2	2					4.2.1.2, 4.2.2.2 ←
3.2.8 Transportability/Transportation		1	1		4		4	4.2.1.1, 4.2.2.1, 4.2.5.4, 4.2.7
3.2.9 Storage	X							
3.2.9.1 Post Acceptance Requirements				2				4.2.3.2
3.2.9.2 Storage/Age Control		3	3		3			4.2.1.3, 4.2.2.3, 4.2.5.3

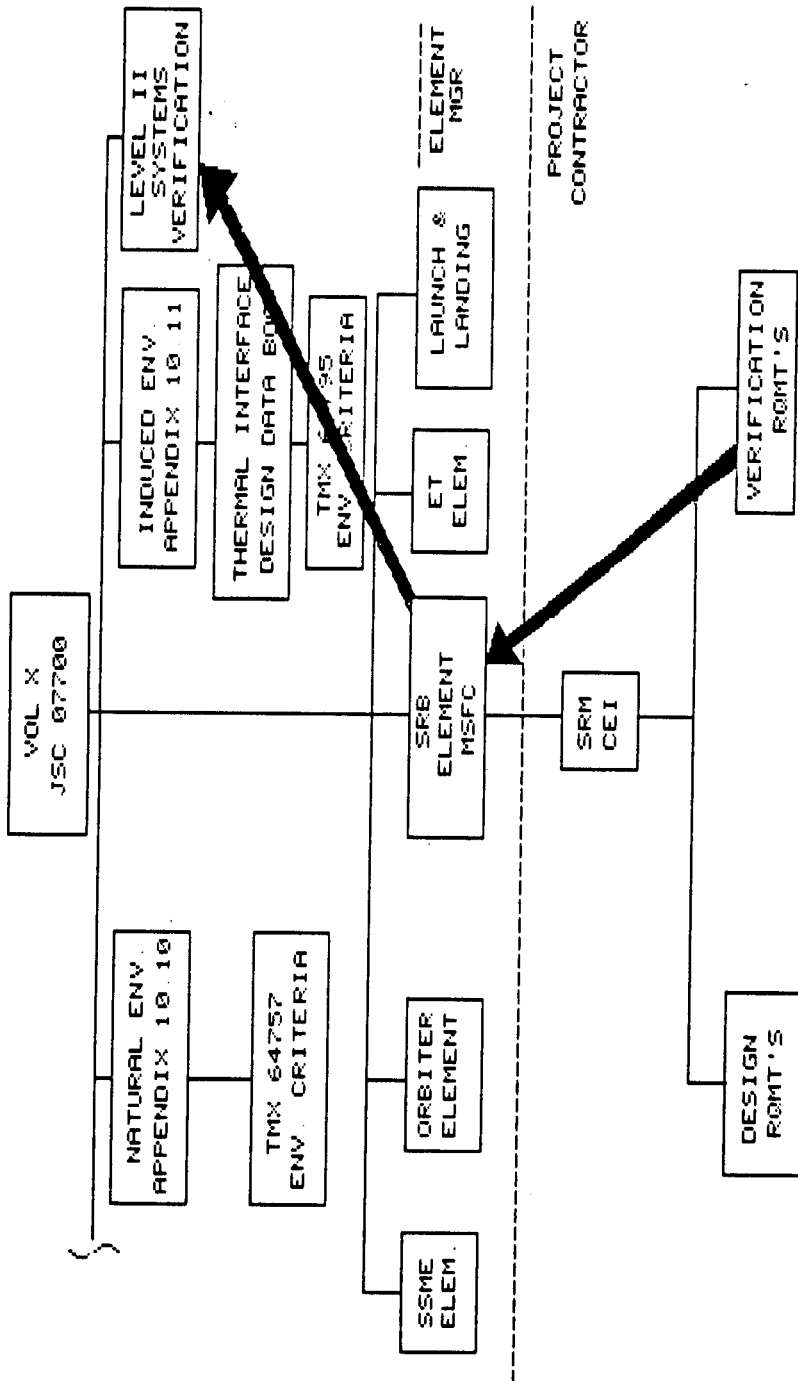

SPECIFICATION VERIFICATION  
-----

- 0 PROJECTS REQUIRED TO SHOW THAT EACH REQUIREMENT IN THE CONTRACT SPECIFICATION HAS BEEN VERIFIED
- 0 ELEMENT MANAGERS REQUIRED TO VERIFY COMPLIANCE WITH LEVEL II REQUIREMENTS THRU VERIFICATION COMPLETION NOTICES

7-15-1

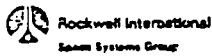

SPACE SHUTTLE SYSTEM  
INTEGRATED ELEMENTS



VERIFICATION COMPLETION NOTICE  
(FRF/FMDF)

IVLN NO.: 12

PAGE 1 OF 3

IVLN TITLE: BASILINE MISSION CAPABILITY

VCN NO.: 12A11

DATE: \_\_\_\_\_

CONSTRAINT: FDF

SCOPE OF IVLN

The Baseline Mission Capability IVLN, as applicable to this VCN, verifies those activities and interrelationships that apply to FMDF constraints. STS-1 flight performance has been evaluated by trajectory simulations utilizing propulsion tag values and specified STS performance. In addition to flight performance reserves and intact abort, yaw steering, insertion point accuracy, ET disposal and flight personnel loads have been evaluated and found satisfactory for STS-1 flight. (See Continuation Sheet)

JSC - 07700 VOL X VERIFICATION REQUIREMENTS COMPLETED

3.2.1.1.2	3.2.1.1.3.4	3.2.1.1.17
3.2.1.1.3	3.2.1.1.4	3.2.1.2.14
3.2.1.1.3.1	3.2.1.1.4.1	3.2.2.1.17.2 ←
3.2.1.1.3.2	3.2.1.1.5	3.2.2.1.17.2.1
3.2.1.1.3.3.1	3.2.1.1.6	3.3.1.2.2.1
3.2.1.1.3.3.2	3.2.1.1.11	3.3.1.3.3.10
		3.3.1.2.5.1

(SEE THE BACK SIDE OF THIS SHEET FOR INCOMPLETE VERIFICATION OR EXCEPTIONS)

APPROVALS

Except as noted on the back side of this sheet:

- Endorsement of this VCN by the Project Managers shall signify completion of element verification to the extent identified on the above cited IVLN and as further defined in the applicable Shuttle Master Verification Plan.
- Endorsement by the Systems Integration Technical Managers shall signify completion of the verification tasks and products defined in the attached VIB-2 data file appendix.
- Systems Integration Manager approval signifies completion of the total integrated systems verification task for the identified network.

ROCKWELL			NASA		
SIGNATURE AND ORGN	DATE	PROJECT	SIGNATURE AND ORGN	DATE	SIGNATURE AND ORGN
<i>[Signature]</i>	11/11/81		TECHNICAL MANAGERS	<i>[Signature]</i>	11-23-81
<i>[Signature]</i>	11/11/81	<i>[Signature]</i>		11-19-81	<i>[Signature]</i>
<i>[Signature]</i>	11/11/81	<i>[Signature]</i>		11-19-81	<i>[Signature]</i>
<i>[Signature]</i>	11/11/81	<i>[Signature]</i>		11-19-81	<i>[Signature]</i>
<i>[Signature]</i>	11/11/81	<i>[Signature]</i>		11-19-81	<i>[Signature]</i>
<i>[Signature]</i>	11/11/81	<i>[Signature]</i>		11-19-81	<i>[Signature]</i>
<i>[Signature]</i>	11/11/81	<i>[Signature]</i>		11-19-81	<i>[Signature]</i>
<i>[Signature]</i>	11/11/81	<i>[Signature]</i>		11-19-81	<i>[Signature]</i>
<i>[Signature]</i>	11/11/81	<i>[Signature]</i>		11-19-81	<i>[Signature]</i>
<i>[Signature]</i>	11/11/81	<i>[Signature]</i>		11-19-81	<i>[Signature]</i>
<i>[Signature]</i>	11/11/81	SYSTEM	<i>[Signature]</i>	3-17-81	<i>[Signature]</i>
PROGRAM MANAGEMENT:			PROGRAM MANAGEMENT: SIGNATURE/DATE		

(24)

*Flight 5 - Sals*



Rockwell International  
Space Systems Group

SPACE SHUTTLE SYSTEM  
INTEGRATED ELEMENTS



VERIFICATION COMPLETION NOTICE

IVLN NO.: 12 PAGE 1 OF 2  
 IVLN TITLE: BASILINE MISSION CAPABILITY VCN NO.: 12A21  
 DATE: OCT 27 1982 CONSTRAINT: OPS

SCOPE OF IVLN

This Baseline Mission Capability IVLN identifies the activities and interrelationships occurring during the Orbital Flight Test phase of the program applicable to verifying the capability of the vehicle to perform the baseline missions specified in the applicable paragraphs of JSC-07700-10. The verification activities accomplished prior to the first flight are identified in VCN No. 12A11. (See continuation sheet)

JSC - 07700 VOL X VERIFICATION REQUIREMENTS COMPLETED

3.2.1.1.2	3.2.1.1.3.4	3.2.1.1.17
3.2.1.1.3	3.2.1.1.4	3.2.1.2.14
3.2.1.1.3.1	3.2.1.1.4.1	3.2.2.1.17.2 ←
3.2.1.1.3.2	3.2.1.1.5	3.2.2.1.17.2.1
3.2.1.1.3.3.1	3.2.1.1.6	3.3.1.2.2.1
3.2.1.1.3.3.2	3.2.1.1.11	3.3.1.3.3.10

(SEE THE BACK SIDE OF THIS SHEET FOR INCOMPLETE VERIFICATION OR EXCEPTIONS)

APPROVALS

Except as noted on the back side of this sheet:

- (1) Enhancement of this VCN by the Project Manager shall signify completion of element verification to the extent identified on the object cited IVLN and as further defined in the applicable Shuttle Master Verification Plan.
- (2) Enhancement by the Systems Integration Technical Manager shall signify completion of the verification tests and products defined in the attached VIB-2 data file segments.
- (3) Systems Integration Manager approval signifies completion of the total integrated systems verification test for the identified network.

ROCKWELL			NAEA			
S/*	SIGNATURE AND ORGN	DATE	SIGNATURE AND ORGN	DATE	SIGNATURE AND ORGN	DATE
TECHNICAL MANAGERS	R.H. Lassen Acoustics	11-4-82			J. Lovingood	12-8-82
	R.H. Lassen Flutter	11-4-82			R. H. Gray	11-5-82
	K.A. Weaver Integ.	11-5-82	J.B. Odom	12-8-82		
	R.A. Burg MPS	11-5-82	L.B. Mulloy	12-8-82		
	W.T. Schleich AGWAC	11-15-82	M.K. Craig Sep	11-3-82	K.J. Cox GN&C	11-3-82
	W.T. Schleich Sep	11-15-82	B.B. Roberts Sep	11-3-82	H.J. Brasseaux MPS	12-14-82
	J.W. Haney Aerothermo	11-22-82	J.G. Hondros Aero	11-16-82	M.C. Coody Acou	11-2-82
	M.R. Schall AscFlt Perf.	11-15-82	J.G. Hondros Asc		G. Strouhal Therm	11-15-82
	E.D. Schlessinger Therm	11-22-82		Flt Perf.	11-16-82	
	W.E. Bornemann Aero	11-24-82	A.L. Mackey Ext Lds	11-10-82		
R.E. Gatto Ext Lds	12-1-82	D.B. Lee Thermo	11-22-82			
SYSTEM	*signatures on file		C.T. Modlin Flutter 11-29-82			
	B. A. Gerstner PROGRAM MANAGEMENT:		PROGRAM MANAGEMENT: SIGNATURE/DATE			

## VI-B

## SOLID ROCKET MOTOR TEAM OVERVIEW COMMITTEE

ALLAN NORTON, CHAIRMAN, MARTIN MARIETTA/ORLANDO  
VICE PRESIDENT, ELECTRONIC SYSTEMS DIVISION

MICHAEL CARD, NASA LANGLEY RESEARCH CENTER  
CHIEF, STRUCTURES AND DYNAMICS DIVISION

AARON COHEN, NASA JOHNSON SPACE CENTER  
DIRECTOR, RESEARCH AND ENGINEERING

MAXIME FAGET, NASA JOHNSON SPACE CENTER (RETIRED)  
SPACE INDUSTRIES

CHARLES FELTZ, ROCKWELL INTERNATIONAL (RETIRED)

LEONARD HARRIS, NASA HEADQUARTERS  
DIRECTOR FOR SPACE

HORACE LAMBERTH, NASA KENNEDY SPACE CENTER  
DIRECTOR, SHUTTLE ENGINEERING

ADRIAN O'NEAL, MCDONNELL DOUGLAS CORP., HUNTSVILLE

DOMINIC SANCHINI , ROCKWELL INTERNATIONAL

SAMUEL TENNANT, AEROSPACE CORPORATION

DAVID L. WINTERHALTER, NASA HEADQUARTERS  
ACTING DIRECTOR, PROPULSION DIVISION

JOHN YOUNG, NASA JOHNSON SPACE CENTER  
CHIEF, ASTRONAUT OFFICE

June 19, 1986

NATIONAL RESEARCH COUNCIL  
COMMISSION ON ENGINEERING AND TECHNICAL SYSTEMS  
Committee on NASA Scientific and Technological Program Reviews

PANEL ON TECHNICAL EVALUATION OF NASA'S PROPOSED REDESIGN  
OF THE SPACE SHUTTLE SOLID ROCKET BOOSTER

NAE Dr. H. Guyford Stever, CHAIRMAN

NAS Foreign Secretary  
National Academy of Engineering  
2101 Constitution Avenue, N.W. (NAS 307)  
Washington, DC 20418

Dr. Alan N. Gent  
Professor of Polymer Physics  
The Institute of Polymer Science  
University of Akron  
Auburn Science Building, Room 325  
Akron, Ohio 44325

Mr. Laurence J. Adams  
(Retired Former President,  
Martin Marietta Corporation)  
13401 Beall Creek Court  
Potomac, MD 20854

Mr. Dean K. Hanink  
(Retired Manager of Engineering  
Operations, Detroit Diesel)  
145 Maple Crest Drive  
Carmel, IN 46032

Dr. David Altman  
(Retired Manager of Engineering  
United Technologies Company)  
1670 Oak Avenue  
Menlo Park, CA 94025

NAE Dr. James W. Mar  
Jerome C. Hunsaker Professor of  
Aerospace Education  
Dept. of Aeronautics & Astronautics  
Massachusetts Institute of Technology  
One Surf Way, Apt. 119  
Monterey, CA 93940

Mr. Robert C. Anderson  
(Retired Vice President,  
TRW Energy Development Group,  
Electronics & Defense Sector)  
Engineering and Management Consultant  
840 55th Avenue, N.W.  
Salem, Oregon 97304

MIT Office:

Professor Edward W. Price  
Regents' Professor  
School of Aerospace Engineering  
Georgia Institute of Technology  
Atlanta, GA 30332

Dr. Jack L. Blumenthal  
Chief Engineer  
TRW  
Materials and Chemistry Applications  
1 Space Park, Building 01, Room 2010  
Redondo Beach, CA 90278

Mr. Robert D. Watt  
(Retired Group Leader,  
Stanford Linear Accelerator Center)  
11117 Palos Verde Drive  
Cupertino, CA 95014

Dr. Robert C. Forney  
Executive Vice President  
E.I. duPont de Nemours & Co., Inc.  
Administration Department  
DuPont Building, Room 9000  
Wilmington, DE 19898

NRC Staff

National Research Council, JH 415  
2101 Constitution Avenue, N.W.  
Washington, DC 20418

Dr. Robert H. Korkegi (Co-Director)

Dr. Myron F. Uman (Co-Director)

Ms. Viviane Scott (Adm. Assistant)



## VI-C

## INFORMATION REQUIREMENT DESCRIPTION

Title:	Type	No.	Date Rev.
Failure Mode Effects Analysis	2	RA-267EB	
<b>Submittal Schedule:</b>			
Submit updates at 6-month intervals with submittal linked to nearest schedule CIL FRR submittal.			
<b>Contract SCW Reference:</b>			
Exhibit A. 3.3.3 - Engineering Support			
<b>Use:</b>			
To identify critical failure modes to be used as a basis for support of: (1) Additional Design Action; (2) Safety Analysis; and (3) Mission Contingency Planning.			
<b>Interrelationship:</b>			
<b>Scope-Contents-Format-Maintenance-Government Furnished Data:</b>			
<ol style="list-style-type: none"> <li>1. <u>Scope/Contents</u> - Failure mode effects analysis will be prepared for each Orbiter Vehicle Subsystem, including the following: <ol style="list-style-type: none"> <li>a. System/Subsystem/Assembly/Item - Identification of item for which the FMEA is being conducted.</li> <li>b. Prepared/Approved By - Identification of analyst who performed the FMEA and individuals responsible for overall FMEA effort.</li> <li>c. Revision - Date individual pages are revised.</li> <li>d. Item Identification: <ol style="list-style-type: none"> <li>(1) Name</li> <li>(2) Identification Number - Drawing number by which the Contractor identifies and describes each component or module.</li> <li>(3) Drawing Reference Designation - Identification of the component or module on the schematic.</li> <li>(4) Quantity - Total number of items in the subsystem.</li> </ol> </li> <li>e. FMEA Number - A number that uniquely identifies the subsystem, component, and failure mode.</li> <li>f. Function - Concise statement of the function performed.</li> </ol> </li> </ol>			
Page 1 of 3			

## INFORMATION REQUIREMENT DESCRIPTION

Title:	No.	Date Rev.
Failure Mode Effects Analysis	RA-26723	
2. <u>Scope/Contents</u> (Continued)		
g. Failure Mode and Cause - Identification of the specific failure mode after considering the four basic failure conditions:		
<ul style="list-style-type: none"> <li>(1) Premature operation.</li> <li>(2) Failure to operate at a prescribed time.</li> <li>(3) Failure to cease operation at a prescribed time.</li> <li>(4) Failure during operation.</li> </ul>		
For each applicable failure mode, describe the major cause(s) including operational and environmental stress factors, if known.		
h. Mission/Phase - Phase of mission in which failure occurs, e.g., Prelaunch: checkout, countdown; Flight: boost phase, earth orbit, etc.		
i. Failure Effect on - Subsystem, interfacing subsystem, mission/crew, element and/or vehicle as required.		
j. Failure Detection Method - A description of the methods by which the failure could be detected.		
k. Correcting Action - An identification of correcting action, automatic or manual, which would be taken to circumvent the failure. Include statement of alternate means of operation and redundancy available after failure.		
l. Failure Mode Criticality Category Designation - Categorize the failure mode criticality in relation to crew safety and mission effect. Include an identification of all items not meeting redundancy requirements during intact aborts.		
Equipment other than criticality 1 shall be further evaluated in accordance with the redundancy hardware screens described below. A notation will be made identifying each screen the hardware does not pass.		
<ul style="list-style-type: none"> <li>(1) The redundant elements are not capable of checkout during the normal mission turnaround sequence, or</li> <li>(2) Loss of a redundant element is not readily detectable by the flight crew, or</li> <li>(3) All redundant elements can be lost by a single credible cause or event such as contamination or explosion.</li> </ul>		
m. Ground Rules and Assumption - Statement of all ground rules and assumptions followed during the performance of FMEA.		
Page 2 of 3		

164 (1679a/C076a)

STS81-J6CCB

## INFORMATION REQUIREMENT DESCRIPTION

Title:	No.	Date Rev.
Failure Mode Effects Analysis	RA-267EB	
2. <u>Scope/Contents</u> (Continued)		
n. <u>Remarks/Hazards</u> - Statement of any remarks, recommendations, and potential hazards as required.		
o. <u>Vehicle Effectivity</u> - Identification of the vehicle effectivity for the failure mode identified.		
3. <u>Format</u> - To be prepared in Contractor's format.		
4. <u>Maintenance</u> - To be maintained by page revision/total reissuance, as applicable.		
5. <u>Government Furnished Data</u> - Not applicable.		
Page 3 of 3		

## INFORMATION REQUIREMENT DESCRIPTION

Title:	Type	ING.	Date Rev.
Failure Mode Effects Analysis	2	RA-267EB	
<b>Submittal Schedule:</b> Submit updates at 6-month intervals with submittal linked to nearest schedule CIL FFR submittal.			
<b>Contract SOW Reference:</b> Exhibit A, 3.3.3 - Engineering Support			
<b>Use:</b> To identify critical failure modes to be used as a basis for support of: (1) Additional Design Action; (2) Safety Analysis; and (3) Mission Contingency Planning.			
<b>Interrelationship:</b>			
<b>Scope-Contents-Format-Maintenance-Government Furnished Data:</b>			
1. <u>Scope/Contents</u> - Failure mode effects analysis will be prepared for each Orbiter Vehicle Subsystem, including the following: <ol style="list-style-type: none"> <li>a. System/Subsystem/Assembly/Item - Identification of item for which the FMEA is being conducted.</li> <li>b. Prepared/Approved By - Identification of analyst who performed the FMEA and individuals responsible for overall FMEA effort.</li> <li>c. Revision - Date individual pages are revised.</li> <li>d. Item Identification:               <ol style="list-style-type: none"> <li>(1) Name</li> <li>(2) Identification Number - Drawing number by which the Contractor identifies and describes each component or module.</li> <li>(3) Drawing Reference Designation - Identification of the component or module on the schematic.</li> <li>(4) Quantity - Total number of items in the subsystem.</li> </ol> </li> <li>e. FMEA Number - A number that uniquely identifies the subsystem, component, and failure mode.</li> <li>f. Function - Concise statement of the function performed.</li> </ol>			
Page 1 of 3			

## INFORMATION REQUIREMENT DESCRIPTION

Title:	NO.	Date Rev.
Failure Mode Effects Analysis	RA-267EB	
2. <u>Scope/Contents</u> (Continued)		
g. Failure Mode and Cause - Identification of the specific failure mode after considering the four basic failure conditions:		
<ul style="list-style-type: none"> <li>(1) Premature operation.</li> <li>(2) Failure to operate at a prescribed time.</li> <li>(3) Failure to cease operation at a prescribed time.</li> <li>(4) Failure during operation.</li> </ul>		
For each applicable failure mode, describe the major cause(s) including operational and environmental stress factors, if known.		
h. Mission/Phase - Phase of mission in which failure occurs, e.g., Prelaunch: checkout, countdown; Flight: boost phase, earth orbit, etc.		
i. Failure Effect on - Subsystem, interfacing subsystem, mission/crew, element and/or vehicle as required.		
j. Failure Detection Method - A description of the methods by which the failure could be detected.		
k. Correcting Action - An identification of correcting action, automatic or manual, which would be taken to circumvent the failure. Include statement of alternate means of operation and redundancy available after failure.		
l. Failure Mode Criticality Category Designation - Categorize the failure mode criticality in relation to crew safety and mission effect. Include an identification of all items not meeting redundancy requirements during intact aborts.		
Equipment other than criticality 1 shall be further evaluated in accordance with the redundancy hardware screens described below. A notation will be made identifying each screen the hardware does not pass.		
<ul style="list-style-type: none"> <li>(1) The redundant elements are not capable of checkout during the normal mission turnaround sequence, or</li> <li>(2) Loss of a redundant element if not readily detectable by the flight crew, or</li> <li>(3) All redundant elements can be lost by a single credible cause or event such as contamination or explosion.</li> </ul>		
m. Ground Rules and Assumption - Statement of all ground rules and assumptions followed during the performance of FMEA.		
Page 2 of 3		

164 (1579a/C075a)

STS81-0600B

## INFORMATION REQUIREMENT DESCRIPTION

Title:	No.	Date Rev.
Failure Mode Effects Analysis	RA-267EB	
<p>2. <u>Scope/Contents</u> (Continued)</p> <p>n. <u>Remarks/Hazards</u> - Statement of any remarks, recommendations, and potential hazards as required.</p> <p>o. <u>Vehicle Effectivity</u> - Identification of the vehicle effectivity for the failure mode identified.</p> <p>3. <u>Format</u> - To be prepared in Contractor's format.</p> <p>4. <u>Maintenance</u> - To be maintained by page revision/total reissuance, as applicable.</p> <p>5. <u>Government Furnished Data</u> - Not applicable.</p>		
Page 3 of 3		

## VI-D

Date: January 31, 1984

Page 1 of 34

Approved: *V.P. Ostrander*V.P. Ostrander,  
Mgr., Reliability  
Space Shuttle ProgramRELIABILITY  
DESK INSTRUCTION

No. 100-26

FLIGHT HARDWAREFAILURE MODE EFFECTS ANALYSIS (FMEA)CRITICAL ITEMS LIST (CIL)References: (1) EOM 70 1-5.1.1.1  
70 2-6.3.1

- (2) Reliability Desk Instruction No. 100-1 - Reliability Evaluation
- (3) Reliability Desk Instruction No. 100-12 - Shuttle Element Interface

INTRODUCTION

Reliability of the design is the ultimate responsibility of Design. However, it is incumbent on other Engineering functions, including Reliability, to support the design engineer in discharging his responsibilities. The Failure Mode Effect Analysis (FMEA) is primary reliability technique for providing design and program support and constitutes a documented record of the design status and coordinated decisions.

1.0 PURPOSE

This desk instruction defines the procedures for generating, documenting and maintaining Failure Mode Effects Analyses (FMEA) and Critical Items Lists (CIL) for the Space Shuttle Orbiter subsystems in order to verify design adequacy with respect to inherent reliability.

2.0 DEFINITIONS

- 1. Failure - is the inability of a system, subsystem, component, or part to perform its required function within specified limits under specified conditions for a specified duration.

2. Failure Mode - a description of the manner in which an item can fail.
3. Hazard - is the presence of a potential risk situation caused by an unsafe act or condition.
4. Redundancy (depth of) - describes the available (number of) ways of performing a function.
5. Backup Mode of Operation - describes the available ways of performing a function utilizing "like" (identical) hardware.
6. Alternate Mode of Operation - describes any additional ways of performing a function utilizing "unlike" hardware.
7. Criticality - is the categorization of a hardware item by the worst case potential direct effect of failure of that item. In assigning hardware criticality, the availability of redundancy (backup or alternate) modes of operation is considered. Assignment of functional criticality, however, assumes the loss of all redundant (backup or alternate) hardware elements. The definition of criticality is shown in Table 2.0.

Table 2.0 - Criticality Definition

<u>CRITICALITY</u>	<u>POTENTIAL EFFECT OF FAILURE</u>
1	Loss of life or vehicle.
2	Loss of mission.
3	All others.
1R	Redundant hardware element, all of which if failed, could cause loss of life or vehicle.
2R	Redundant hardware element, all of which if failed, could cause loss of mission.

NOTE: See Appendix B, paragraph 3.1.1, Ground Rules, sub-paragraphs 1 and 2.

8. Single Failure Point (SFP) - is a single item of hardware, the failure of which would lead directly to loss of life, vehicle, or mission. Where safety considerations dictate that abort be initiated when a redundant item fails, that item is also considered a single failure point.



9. Functional Mode - identifies each function to be performed by the item being analyzed.
10. Multiple Order Failure - describes the failure due to a single cause or event of all units which perform a necessary (critical) function.
11. Critical Item - a single failure point and/or a redundant element in a life or mission-essential application where:
  - a. Redundant elements are not capable of checkout during the normal ground turnaround sequence.
  - b. Loss of a redundant element is not readily detectable in flight.
  - c. All redundant elements can be lost by a single credible cause or event such as contamination or explosion.
12. Kit - For the purposes of this desk instruction, a kit is defined as a temporary addition or modification to the Orbiter or its subsystems to satisfy unique requirements for a specific mission.
13. Post Landing Safing Operations - For the purposes of this desk instruction, post landing safing operations are defined as those activities performed after landing to prepare the Orbiter for hangar operations. This includes the deservice and draining of all hazardous fluids, safing of unused ordnance, application of ground power and cooling, removal of potentially hazardous components, pods and payloads, purging and venting of gases and the installation of protective covers.
14. Prelaunch Operations - Prelaunch operations for propulsion subsystems is defined as beginning with propellant loading for each specific subsystem. For all other subsystems prelaunch operations commence with start of main engine conditioning.

### 3.0 FMEA/CIL PREPARATION

FMEA's will be prepared jointly by the responsible designer and the assigned Reliability Subsystem Analyst (RSA) in accordance with the attached format, Appendix D (Ground Rules and Criteria) and as shown in FIGURE 1. Safety, other engineering disciplines, and technical support functions (see EOM Directive

70 2-6.3.1) will provide support as required. Where the FMEA deviates from the instructions and ground rules contained herein, appropriate notation will be included within the "Ground Rules and Criteria" of the FMEA preface.

### 3.1 SCHEDULE

Reliability, in coordination with Design, will define the schedule and depth of detail for each FMEA to be prepared for the Orbiter in support of contractual requirements, and issue an FMEA schedule.

### 3.2 CONTENT

Each subsystem FMEA/CIL shall be prefaced by the following information, sequenced as indicated:

- 1.0 INTRODUCTION
- 2.0 QUALITATIVE RELIABILITY SUMMARY
  - 2.1 SUBSYSTEM DESCRIPTION AND EFFECTIVE DATE
  - 2.2 SIGNIFICANT UNDEFINED DESIGN AREAS
  - 2.3 CRITICAL ITEMS SUMMARY
- 3.0 GROUND RULES AND CRITERIA
- 4.0 DISPLAYS AND CONTROLS INDEX
- 5.0 LIST OF REFERENCE DOCUMENTS
- 6.0 SCHEMATICS

The backup information, including rationale and analyses involved in assessing failure modes and their effects, generally is not included in the final FMEA and CIL package. Where such information exists in the form of notes, calculations, IL's, references and other similar material, it will be retained by the responsible RSA. Should the RSA be reassigned, he will turn over the material to his supervisor.

### 3.3 ANALYSIS REQUIREMENTS

1. FMEA's will be performed for each functional mode of a subsystem or functional kit. Electrical FMEA's will be conducted to the "black box" level and within the "black box" to pursue functions which have single failure point potential effect on the orbiter safety or mission success. The level of detail required in mechanical FMEA's below the component level in pursuit of critical failure modes will vary. Standard design, such as check valves, relief valves, isolation valves, etc., require only common types of failure causes to be listed.

EXAMPLE: Failure Mode - internal/external leakage.  
Cause - poppet/seat damage, contamination,  
structural failure.

When a component is a non-standard type of design or is unique in application or contains unusual/unique failure modes of a critical nature, a more detailed analysis is required. Piece parts and their failure modes and effects that could result in component critical failure modes must be identified and included in the "CAUSE" section of the component FMEA for each component failure mode of concern.

EXAMPLE: Spring - fracture, structural failure - poppet fails to seat.

2. FMEA's for mechanical systems and avionics will interface at the connector. (See section 4.3.4, Mechanical/Electrical Interface.)
3. All identified failure modes will be assigned two criticalities (functional and hardware) based on the definitions in section 2.0, Definitions, and procedures contained in sections 4.3.1 and 4.3.2, Hardware and Functional Criticality Determination.
4. The criticality assigned to pressure carriers (pressure lines and vessels) shall reflect the worst case failure effect. These include potential shrapnel damage to the vehicle/subsystems resulting from rupture of non-filament wound tanks, potential overpressurization caused by releasing substantial quantities of fluids from ruptured lines or tanks, or depletion of consumables. Where released fluids are flammable or oxidizers and the possibility of an ignition source exists, appropriate notation will be entered under "HAZARDS" for Safety action. (See Appendix B, paragraph 3.1.1, Ground Rules, subparagraphs 13, 14, and 15.)
5. Failures which could occur during all mission phases from prelaunch through deactivation (including safing & purging) of subsystems subsequent to landing and during ferry flights shall be considered, regardless of occurrence probability. Documentation of prelaunch analysis is required only for items classified as criticality 1/1.

6. All ordnance/pyrotechnic items will be listed in the CIL according to the most severe effect (criticality 1 or 2) of a premature operation.
7. Each hardware or function critical item summary will include a count of the total number of critical failure modes per item, by criticality, classified either structural or functional (see paragraph 4.1.11).
8. Critical item summaries for kits will be included, but identified separately.
9. FMEA's will not be required on structures, wire harnesses, cables and electrical connectors. For all critical circuits where a short between adjacent connector contacts could result in loss of crew (MSC D&P Standard No. 32), the design schematics shall be reviewed to verify that this condition does not exist. The incorporation of a switch on the ground side that precludes an adjacent contact short to result in crew loss is considered acceptable for meeting the MSC D&P Standard No. 32 requirement.  
  
For all other critical circuits, separation of redundant functions will be verified by selective review of design schematics to insure that the requirements for separation have been incorporated and complied with.
10. Logic diagrams (ref. Desk Instruction 100-1, Reliability Evaluation) will be developed only where required to provide proper correlation between schematics and FMEA's.
11. Those components that are criticality 3 (functional and hardware) in the electrical circuits by "black box" criticality may be listed on one FMEA for for that circuit. Those components that are hardware criticality 1 or 2 will have individual FMEA's. Those components that are criticality 1R or 2R, and appear in the CIL, will have individual FMEA's.

#### 4.0 IMPLEMENTATION

A program has been developed to provide computer printout of FMEA and CIL data. Format examples of these printouts are shown in FIGURES 2 and 3. The following section contains instructions for documenting the FMEA. Data entry

0246j/6

sheets (FIGURES 4 and 5) will be completed by the RSA as information becomes available. The information will be entered into the computer and the RSA will receive a copy of the resultant data printout (FIGURES 6 and 7) which will comprise a working document of the information stored in the computer and a baseline for additional inputs or revisions.

#### 4.1 DATA ELEMENTS

The following procedure describes the information to be filled out on Data Sheets 1 and 2 (FIGURES 4 and 5). Each data descriptor is preceded by the entry code for that item (e.g., LV1, Subsystem ID). These codes also are shown on the examples of the FMEA and CIL formats, FIGURES 2 and 3, for information.

#### DATA SHEET NO. 1

4.1.1 (DI, LV1, LV2) DATA IDENTIFIER: This line uniquely identifies the component being analyzed and the "update" information to be taken.

- a. Circle "A", "R" or "D" to indicate appropriate action --
  - A - Add a new record (component or assembly).
  - R - Review an existing record by adding, deleting, or revising an element(s) of that record.
  - D - Delete an entire record and all information in that record.
- b. SUBSYSTEM ID (LV1): Enter the last two digits of the applicable designator and dash number. (See TABLE 4.0).
- c. COMPONENT ID (LV2): Enter a number which uniquely identifies the particular component being available. If an existing schematic identifier is available, it may be used. For computer printout purposes, the first digit(s) of the number shall be selected to indicate the assembly. The use of special characters such as periods or dashes will be avoided.

4.1.2 (C1) ASSEMBLY NAME: Enter the name of the assembly.

4.1.3 (C1, J1) ITEM NOMENCLATURE: Enter the nomenclature for the component. In the first block (C2), give the basic identifying noun. Enter any additional modifiers or description on the J1 line. A typical example is "Valve, Solenoid", where "valve" is the basic identifier.

Table 4.0 - IDENTIFIERS &amp; SUBSYSTEM NAMES

01-5 PURGE, VENT & DRAIN	05-1 GUIDANCE, NAVIGATION & CONTROL
02-1 LANDING DECELERATION	COMMUNICATIONS & TRACKING
02-2 DOCKING MECHANISM	05-2A AUDIO
02-3 SEPARATION MECHANISM	05-2B UHF
ACTUATION MECHANISMS	05-2C TACAN
02-4 DOORS	05-2D ALTIMETER
ET Umbil door	05-2F MICROWAVE SCAN BEAM LANDING (MSBLS)
Star Tracker	05-2G S-BAND
Air Data Sensor	05-2J PAYLOAD INTERRAGATOR
02-4A HATCHES	05-2K CLOSED CIRCUIT TV (TV)
02-4B PAYLOAD BAY DOORS	05-2R KU-BAND COMM & RADAR
02-4C RUDDER/SPEEDBRAKE, BODY FLAP	05-3 DISPLAYS & CONTROLS
02-5 PAYLOAD RETENTION/DEPLOYMENT MECHANISMS	05-4 INSTRUMENTATION
02-6 HYDRAULICS	05-5 DATA PROCESSING & SOFTWARE & COMPUTERS
03-1 MAIN PROPULSION	*05-6 ELECTRICAL POWER DISTRIBUTION & CONTROL
03-2 REACTION CONTROL	05-8 BACKUP FLIGHT CONTROL
03-2A AFT	06-1 ATMOSPHERIC REVITALIZATION (ARS, ARPCS, Airlock)
03-2B FORWARD	06-2 LIFE SUPPORT
03-3 ORBITAL MANEUVER	06-3 ACTIVE THERMAL CONTROL & WATER SPRAY BOILER
04-1 ELECTRICAL POWER - CYRO	07-1 CREW PROVISIONS, ACCOMMODATIONS & EMERGENCY EGRESS
04-1A ELECTRICAL POWER - FUEL CELL	07-2 CREW ESCAPE - 102 PRE-AAMOD ONLY
04-2 AUXILIARY POWER (APU)	07-3 TUNNEL ADAPTER

\*See TABLE 5.0 for EPD&C/INTERFACING SUBSYSTEM IDENTIFIERS

0246j/8

Table 5.0 - EPD&amp;C/INTERFACING SUBSYSTEM IDENTIFIERS

<u>ELECTRICAL</u>	<u>INTERFACE</u>	<u>MECHANICAL SUBSYSTEMS</u>
05-6AA	01-5	Purge, Vent & Drain
05-6AB	01-5	Vent Doors
05-6B	02-1	Landing Deceleration
05-6BA	02-1	Landing Gear Control
05-6BB	02-1	Brake & Anti-Skid
05-6BC	02-1	Nosewheel Steering
05-6C	02-2	Docking Mechanism
05-6D	02-3	Separation
05-6DA	02-3	Carrier A/C Separation
		<u>ACTUATION MECHANISMS SUBSYSTEMS</u>
05-6EA	02-4A	Hatches
05-6EB	02-4B	Payload Bay Door
05-6EC	02-4C	Rudder/Speedbrake, Body Flap
05-6ED	02-4	ET Umbilical Doors
05-6EE	02-4	ADP Deploy & Htr
05-6EF	02-4	Star Tracker Doors
05-6EG	02-4	Freon Radiator Deploy
05-6EH	02-4	Rendezvous Radar & Comm. Antenna Deploy
05-6F	02-5	Payload Retention, Manipulator Positioning
05-6G	02-6	Hydraulics
05-6IA	02-5	Remote Manipulator Arm
05-6IB	02-5	Manipulator Deploy Control
05-6IC	02-5	Manipulator Latch Control
05-6ID	02-5	Manipulator Arm Shoulder Jettison & Retention Arm Jettison
05-6IE	02-5	DAC Camera-PLB OPS
		<u>PROPULSION SUBSYSTEMS</u>
05-6J	03-1	Main Propulsion
05-6KA	03-2A	Reaction Control-Aft
05-6KF	03-2F	Reaction Control-Fwd
05-6L	03-3	Orbital Maneuvering
05-6LA	03-3	OMS Auxiliary Kit
		<u>POWER GENERATION SUBSYSTEMS</u>
05-6MA	04-1A	Electrical Power Generation - Fuel Cell
05-6MB	04-1	Electrical Power Generation - Cyro
05-6N	04-2	Auxiliary Power Unit

Table 5.0 - (Cont'd.)

<u>ELECTRICAL</u>	<u>INTERFACE</u>	<u>AVIONICS SUBSYSTEMS</u>
05-60	05-1	Guidance, Navigation & Control Communications & Tracking:
05-6PA	05-2A	Audio
05-6PB	05-2B	UHF
05-6PC	05-2C	TACAN
05-6PD	05-2D	Altimeter
05-6PF	05-2F	Microwave Scan Beam Landing (MSBLS)
05-6PG	05-2G	S-Band
05-6PJ	05-2J	Payload Interragator
05-6PK	05-2K	Closed Circuit TV (TV)
05-6PH		Ground Command Interface Logic (GCIL)
05-6PR	05-2R	Ku-Band Comm. & Radar
05-6Q	05-3	Displays & Controls
05-6R	05-4	Instrumentation
05-6S	05-5	Data Processing & Software
05-6T	05-8	Backup Flight Control
05-6	05-6	Electrical Power Distribution & Control
		<u>ECLSS SUBSYSTEM</u>
05-6U	06-1	Atmospheric Revitalization - ARS, ARPCS
05-6UA	06-1	Airlock Environmental Control
05-6V	06-2	Smoke Detection, Fire Suppression
05-6VA	06-1	ARPCS
05-6VB	06-2	Galley
05-6VC	06-2	Waste Management
05-6VD	06-2	Water Management
05-6W	06-3	Active Thermal Control
05-6Y	07-1	Crew Station & Equipment
05-6Z	07-2	Crew Escape



- 4.1.4 (J10) FUNCTION: Describe the function performed by the component. Also, enter the component designator(s) as identified on the design schematic.
- 4.1.5 (E4, C5, C6) QUANTITY: Enter the total number of items having identical part numbers performing the same function in the subsystem. The E4 field will reflect the total quantity in Arabic numerals. The C5 and C6 fields will reflect written quantities.
- 4.1.6 (C7, C8) PART NUMBER:
- a. C7) ROCKWELL PART NUMBER: Enter the appropriate Rockwell part number in accordance with the following DRM/SRM example, starting at the most left-hand-position -
    - (1) VO70-XXXXXX (Airborne, In-House)
    - (2) MEXXX-XXXX (SCD)
    - (3) MCXXX-XXXX (Procurement Spec)

Note: Dash numbers to basic part numbers are required when the basic part number has dash numbers having differences in the failure mode and effects.
  - b. (C8) SUPPLIER PART NUMBER & SUPPLIER NAME: Enter supplier part number and supplier name (abbreviate if required) when available for ME and MC part numbers.
- 4.1.7 (C11-14) REFERENCE DOCUMENTS: Enter the referenced schematic diagram first, followed by the related block diagrams, logic diagrams, etc.
- 4.1.8 (C9, C10) FMEA PREPARED BY: Enter the initials and last name of the Reliability Subsystem Analyst and Design Engineer who prepared the subsystem FMEA.

## DATA SHEET NO. 2

- 4.1.9 (DI, LV1, LV1) DATA IDENTIFIERS: Indicate appropriate action and specify the subsystem and component ID as described for Data Sheet No. 1.
- 4.1.10 (LV3) FAILURE MODE SEQUENCE: Assign different sequence numbers (e.g., 1, 2 - 5) for various failure modes of the specified component.  
Do not use leading zero's.  
Example: (LV3)     1, NOT (LV3) 0 0 0 1.

4.1.11 (C31, J130, C32) FAILURE MODE: Enter first the basic failure mode (keyword) (C31), then any additional modifiers (J130) necessary to fully describe the specific failure mode - the exact manner in which the item fails. Failure mode keyword identifiers are listed below. Selection should include but not be limited to those listed.

FAILURE MODE KEYWORD IDENTIFIERS

- |                                |                          |                             |
|--------------------------------|--------------------------|-----------------------------|
| • STRUCTURAL FAILURE (RUPTURE) | • INADVERTENT OPERATION  | • PREMATURE OPERATION       |
| • PHYSICAL BINDING/JAMMING     | • INTERMITTENT OPERATION | • DELAYED OPERATION         |
| • FAILS TO REMAIN OPEN/CLOSED  | • ERRATIC OPERATION      | • ERRONEOUS OUTPUT          |
| • FAILS MID-TRAVEL             | • ERRONEOUS INDICATION   | • LOSS OF OR PARTIAL OUTPUT |
| • FAILS TO OPEN/CLOSE          | • RESTRICTED FLOW        | • SHORTED                   |
| • INTERNAL/EXTERNAL LEAKAGE    | • FAILS TO START/STOP    | • OPEN (ELECTRICAL)         |
| • FAILS OUT OF TOLERANCE       | • FAILS TO SWITCH        | • LEAKAGE (ELECTRICAL)      |

Appendix B, paragraph 3.1.1, sub-paragraph 13, reflects the ground rule to be used for external leakage. For OV-102 pre-AA mod only, those failure modes which result in a criticality classification of 1 and 2, or 1R and 2R, and appear in the CIL (item 4.1.22) shall be classified further as structural or functional failures by circling "S" or "F" in the C32 field. The following guidelines apply:

STRUCTURAL (S) - A failure mode involving structural failure of a pressure vessel, component housing, fluid lines, attach fittings, or load-carrying members such as cranks or rods.

FUNCTIONAL (F) - A failure mode, generally within a component, which negates the described component function. This type of failure would include binding, leakage, failure to open or close, or loss of output. The failure cause could be improper installation of parts or structural failure of power transmitting parts such as gear teeth, shafts or springs; however, in such instances the mode is still classified as functional. Electrical and electronic component failures would normally fall in this category.

4.1.12 OV-102 PRE-AA MOD ONLY:

(C62-66) APPLICABLE MISSIONS: Enter an "X" in the block of the mission to which the FMEA applies.

Horizontal Flight Test	C62
Vertical Flight Test	C63
Ferry Flight	C64
Operational Flights	C65
Specific Orbital Mission	C66

Note: "Operational Flights" and "Specific Orbital Mission" are not to be used for the duration of OV-101 and OV-102 flight test programs.

OPERATIONAL VEHICLE(S):

(C83 - C86) VEHICLE EFFECTIVITY: Enter an "X" in the appropriate block(s) to which the FMEA applies.

Orbiter Vehicle 102	C83
Orbiter Vehicle 099	C84
Orbiter Vehicle 103	C85
Orbiter Vehicle 104 & SUBS	C86

4.1.13 (C33-37) MISSION PHASE(S): Enter an "X" in appropriate box(es) to indicate when the specified effects would be manifested. If the failure occurs at discrete points in time within a given mission phase, and different effects may be observed, it may be necessary to define the subphase or event under "EFFECTS".

4.1.14 (C38, C58) ABORT CRITICAL COMPONENTS:

- a. For those items whose criticality is increased to 1/1 during an abort resulting from unrelated failures, enter the word "Abort" (C38 - six spaces only), followed by the appropriate acronym(s); i.e.,
  - (C58) RTLS - Return to Landing Site
  - (C58) AOA - Abort Once Around
  - (C58) ATO - Abort to Orbit
- b. For non-redundant modes where normal mission effect is criticality 3 but are hardware criticality 1 unique to intact abort, classify these modes

as hardware criticality 1 and functional criticality 1. Add in J10 (FUNCTION) the notation, "Unique to Intact Abort". Add appropriate intact abort notation in a. above.

Additional information must also be entered under J240, EFFECT(S) - see paragraph 4.1.16. **NOTE:** For SSME induced aborts, maximum two engine burn time is approximately twelve minutes. If "TIME TO EFFECT" is equal to or greater than twelve minutes, there is no change in criticality.

4.1.15 (J380) **CAUSE(S):** Enter causes including but not limited to those listed below and amplify as necessary. See paragraph 4.4.2 for instructions on supplier furnished piece parts.

#### CAUSES

- CONTAMINATION
- MECHANICAL SHOCK
- VACUUM
- ACOUSTICS
- OVERLOAD
- MISHANDLING OR ABUSE
- TEMPERATURE (HIGH/LOW)
- THERMAL SHOCK
- PRESSURE (HIGH/LOW)
- IONIZING RADIATION
- ACCELERATION
- ELECTROMAGNETIC FIELDS
- INADVERTENT OPERATION/ACTIVATION
- VIBRATION
- PROCEDURAL ERROR
- CHEMICAL REACTION
- LOSS OF/IMPROPER INPUT
- PIECE-PART STRUCTURAL FAILURE

4.1.16 (J240) **EFFECT(S):** Enter the letters (A), (B), (C) or (D) as defined in the headings of Appendix A, together with the words under each heading describing the effects on the subsystem, interfaces, mission, and crew/vehicle, respectively, and explain. If the identified effect is not listed, describe briefly. Where the effect is the same for two or more of the above, consolidate entries. Specify if there is no effect on a specific category or categories and provide a brief explanation. In those instances when time to abort requires automatic operation or immediate dependence on a parallel subsystem and such is provided, the effect on mission is "None" with explanation for each mission phase as appropriate. See section 4.1.21d. for screening of functional criticality 3 failure modes. For those items identified as abort critical (see paragraph 4.1.14) enter, subsequent to the (A), (B), (C) and (D) entries, the criticality and effects per the following example:

"Crit 1 for RTLS - Loss of additional engine-vehicle loss"

or

"Crit 1 for RTLS - Incomplete propellant dump, stability problem, probable vehicle loss."

Where functional criticality is 1R or 2R per paragraph 4.3.2 and hardware criticality is 3, the appropriate entry for "FUNCTIONAL" effects should be included. The "FUNCTIONAL" effects entry relative to the loss of all functional redundancy will be entered per the following example:

(E) FUNCTIONAL CRITICALITY EFFECT:

Possible loss of crew/vehicle (specify) or probable loss of crew/vehicle (describe) or loss of crew/vehicle.

4.1.17 (C39) TIME TO EFFECT:

Immediate - less than 1 second  
 Seconds - 1 to 50 seconds  
 Minutes - 50 seconds to 50 minutes  
 Hours - 50 minutes to 20 hours  
 Days - 20 hours to mission completion

Enter the descriptor which indicates shortest credible time or time range available to correct the situation before the effect is manifested.

4.1.18 (C40-45) FAILURE DETECTABLE: Enter "YES" or "NO" in the block following "IN FLIGHT" and "GROUND TURNAROUND". If either answer is "YES", indicate how it can be detectable -- symptoms, instrumentation, etc. Include measurement number from MML (Master Measurements List) where applicable and available. (See section 4.3.5, Instrumentation FMEA's.) Development flight instrumentation (DFI) measurements will not be used as a means of detectability.

4.1.19 (J490) CORRECTING ACTION: Describe any action, automatic or manual, which may be taken to circumvent the specified failure. Also identify any alternate means (utilizing "unlike" hardware) of accomplishing the function performed by the item or its assembly. If none, so indicate. For instruments (sensors, transducers, etc.) that provide measurements assessed

as critical to vehicle/crew safety or mission continuation, the FMEA shall identify the redundant or alternate measurements by Measurement List identification number.

4.1.20 (C77) NUMBER OF SUCCESS PATHS REMAINING AFTER FIRST FAILURE: With respect to the item being evaluated, indicate the number of ways remaining to perform the function after the first failure. You may leave the block blank for non-critical functions.

4.1.21 (C53, C55-57) REDUNDANCY SCREEN: For all criticality 1R, 2 and 2R failure modes (see FIGURE 8 and paragraphs 4.3.1 and 4.3.2) circle "P" (PASS), "F" (FAIL), or "NA" (NOT APPLICABLE) for each of the following tests:

- a. Redundant elements are capable of checkout during normal ground turnaround with no vehicle design modification. Where a subsystem is characterized by redundant strings and the status of each string can be verified during ground turnaround, no individual component(s) in any one string should be shown as failing this screen.

NOTE: This screen is not applicable under the following conditions:

- (1) Pyrotechnic devices, excluding electrical control circuitry.
- (2) Non-redundant item.

- b. Loss of a redundant element is readily detectable during flight. Where a subsystem is characterized by redundant strings and the status of each string can be verified in flight, no individual component(s) in any one string should be shown as failing this screen.

NOTE: This screen is not applicable under the following conditions:

- (1) Standby redundancy (redundant paths were only one path is operational at any given time).
- (2) All functional paths of any subsystem which is inoperative (during such inoperative periods). This groundrule does not apply if the redundant elements are operative during any normal mission phase; i.e., the screen is considered applicable if the element is operative during any normal mission phase.
- (3) Pyrotechnic devices.
- (4) Mechanical linkage.
- (5) Non-redundant item.
- (6) Subtier level redundant functional path(s) (power/control circuits, etc., failures where the primary functional path (LRU, etc.) is

Criticality 1R3 or 2R3 and the primary redundancy would not be degraded (i.e., loss of two of the subtler functional paths would not result in an abort decision).

- c. Failure of an element to pass this screen should be in direct relation to the noted failure mode under normally expected environmental conditions. Consideration of environmental extremes as caused which could induce "multiple order failure" is limited to abnormal conditions generally resulting from some other failure. Where multiple failures must first occur to result in environmental extremes, such events may be considered non-credible. As a ground rule, it may be assumed that hardware items will be qualified and properly installed to withstand the "design-to" environmental envelope. The following are typical questions to be answered in this phase of the analysis:

(1) Contamination:

- (a) Are the items being evaluated susceptible to contamination?
- (b) Is contamination a credible event or does the design (including filters) result in this failure mode being categorized as non-credible?

(2) Explosion:

- (a) Is there a credible source?
- (b) Must other multiple failures occur first to result in the explosion?
- (c) Is the explosion catastrophic to crew or vehicle?
- (d) Is the container frangible?
- (e) Are the items being considered susceptible to this type of damage in view of their physical characteristics and location; i.e., shielding?

3. Temperature:

- (a) Are components susceptible to damage or failure from high temperature?
- (b) Other than as a result of multiple failures, is such exposure credible? This implies temperature peaks or sustained levels sufficient to cause catastrophic effects on the component in a short time. For example, temperature increases to certain levels merely increase electronic parts failure rates - the actual failure and time of occurrence are still probabilistic.

- (4) Vibration, Shock, Acceleration, Acoustics, etc.:
- (a) Assuming that components are qualified and properly installed to withstand design environments, can a credible cause be identified which would cause these levels to be exceeded?
  - (b) Are vibration/shock/acceleration-sensitive redundant units physically oriented or separated to reduce the chance of multiple failure from the same cause(s) and is there sufficient analysis and test data to verify the failure as non-credible?

(5) Fire:

Do not consider fire as one of the single events or causes in failing screen "C". NASA has edicted that fire not be considered one of the events (NB/83-L 216).

If none of the redundancy screens are applicable, enter "NA" in the C53 field and briefly explain reason for REMARKS/HAZARDS.

d. Screening of Functional Criticality 3 Failure Modes

- (1) Where the failure modes have been identified as non-critical for loss of all redundancy (Criticality 3), enter "NA" in the C53 field. Enter under "REMARKS" the notation, "Criticality 3 failure mode - loss of all redundancy would have no effect on the mission or crew/vehicle safety". In such cases, minimum entries on Data Sheet No. 2 consist of DI, LV1, LV2, LV3, C31, C53 and J240. For functional Criticality 3 items, J240 must contain a brief explanation regarding the assigned criticality.
- (2) Where a component has an identified failure mode in the Criticality 1 of 2 category, and additional functional Criticality 3 failure modes are identified, these Criticality 3 modes will be treated as described in para. (1) above.

4.1.22 CRITICALITY:

- a. (C54 - HARDWARE) - Enter 1, 2 or 3 based on the definitions in section 2.0 and the ground rules contained in section 4.3.1 and Appendix B, paragraph 3.1.1, sub-paragraph 1.
- b. (C67 - FUNCTIONAL) - Enter 1, 2, 1R, 2R or 3 based on the definitions in section 2.0 and the ground rules contained in section 4.3.2 and Appendix B, paragraph 3.1.1, sub-paragraph 1.



- 4.1.23 (J500) REMARKS/HAZARDS: Identify potential hazards resulting from the specified failure. Enter the words "Hazard Potential" followed by appropriate explanation and any other comments or recommendations that might prove useful in evaluating the system. Indicate requirements for additional instrumentation, and any other special consideration.
- 4.1.24 (J600) DISPOSITION AND RATIONALE: For criticality 1 and 2 items, and/or 1R, 2R items that fail a redundancy screen and/or hardware criticality 2 items where the screen is NA, in all of the following categories to describe the retention criteria. Each category must reflect a description of rationale for retention of the item:
- a. Design - Identification of design features which minimize the occurrence of the failure mode and causes.
  - b. Test - identification of specific tests accomplished to detect failure mode and causes during acceptance tests, certification tests, and checkout tests.
  - c. Inspection - Statement that specific inspection points are included to determine that specific failure mode causes are not inadvertently manufactured into the hardware.
  - d. Failure History - Provide an indication that the hardware or similar hardware has been used successfully and that a history of generic failures does not exist. If the hardware is new to this program, so state.
- 4.1.25 (C9, C10) APPROVAL: Responsible Reliability and Design approval signatures as follows:
- a. Subsystem FMEA package: Design/Reliability Manager
  - b. Figure 2 (FMEA) - PREPARED BY: Design \_\_\_\_\_ Responsible  
Reliability \_\_\_\_\_ Analyst's Name  
APPROVED BY: Design \_\_\_\_\_ Signature  
Reliability (Analyst) \_\_\_\_\_ Signature
  - c. Figure 3 (CIL) - APPROVED BY: Design (Supervisor) \_\_\_\_\_ Signature  
Reliability (Supervisor) \_\_\_\_\_ Signature

NOTE: The initial issue of a CIL sheet will be signed by the Reliability Supervisor. Signatures will not be required on subsequent issues unless the CIL sheet is revised.

02464710

**4.2 REVISIONS & SUBMITTALS****1. Revisions to the FMEA will be made as follows:****a. New Data:**

- (1) To identify new components or failure modes, use the data entry sheets and follow the instruction given in section 4.1.
- (2) To add information to a component or failure mode record, either a blank data sheet or the appropriate page of the data printout working copy may be used.
  - (a) Data Entry Sheets - Using a blank data sheet, circle "R" (Revise) on the "Data Identifier" line (DI, FIGURE 4 or 5) and enter the correct subsystem/component/(failure mode) ID number to identify the record to which the information is to be added. Fill in complete blocks of information to be added (e.g., Disposition block), and submit for keypunching.
  - (b) Data Printout - Circle "R" (Revise) on the "Data Identifier" line (DI, FIGURES 6 and 7) of the record to which new information is to be added. Using a colored pen or pencil, enter the information in the appropriate blocks and submit for keypunch.

**b. Data Entry Change:**

- Circle the "R" (Revise) on the "Data Identifier" line (DI, FIGURE 4 or 5) and either "red-line" the appropriate sheet of the data printout or re-enter the data as it should appear, using the appropriate data entry sheet as described in section 4.2, paragraph (a) Data Entry Sheets. To clear the "J" field of any remaining unwanted information, asterisk (\*) the blank lines within the block on the master record and supporting record work sheets.

**c. Data Deletion:**

- (1) To delete data, circle the "R" on the "Data Identifier" line (DI, FIGURE 6 or 7) of the appropriate data printout sheet, cross out the entry to be deleted with a colored pen or pencil

and submit for keypunching. If a blank data sheet is used, enter an asterisk (\*) in the block which corresponds to the entry to be deleted.

- (2) To delete the entire record (i.e., all data pertaining to a particular failure mode or component) and all related entries, circle the "D" (Delete) on the appropriate sheets of the data printout. Again, filling out the data identifier line of a blank data sheet will accomplish the same purpose. All information pertaining to a particular component or failure mode will be deleted.

d. Data Identifier Change:

To change a data identifier (LVI, 2 or 3), it is necessary to delete the entire record under the old number and re-enter (add) under a new number. The B999/revision data on computer reports is automated and prints the date of the latest update or revision.

e. Identification of Revisions/Changes:

Identify each line changed with a vertical black bar on the left-hand margin of the page.

2. FMEA/CIL Submittal

a. Critical Items List (CIL)

Updates will include the following:

- (1) Any new CIL items
- (2) Updates to existing items having technical changes affecting the following sections:
  - (a) function
  - (b) failure mode
  - (c) failure effects
  - (d) criticality
  - (e) abort critical components
  - (f) failure detectability (redundancy screen)

Other changes will be incorporated when pages are submitted for the above reasons.

## b. FMEA's

Updates of the FMEA's will be at six month intervals linked to nearest scheduled CIL FRR publication. Only those changes related to the CIL submittals (a above) and other technical changes will be submitted.

4.3 IMPLEMENTATION GROUND RULES (See also Appendix B - Ground Rules and Criteria)4.3.1 HARDWARE CRITICALITY DETERMINATION

Hardware criticality will be determined by the categorization of the singular effect of the identified failure mode on the subsystem/vehicle (See FIGURE 10). FIGURE 8 illustrates the analytical logic for criticality determination of all functional hardware.

1. Reliability Engineering identifies hardware where if redundancy fails the effect would be critical.
2. Reliability and Design Engineering jointly identify those equipments with (single point) criticality 1 or 2 failure modes. Those equipments that are not criticality 1 because they incorporate redundancy are then screened further, as described in paragraph 4.1.21, and appropriate entries made in the FMEA data sheet.

NOTE: The criticality of instrumentation and test ports will be assessed according to their function. Test ports, when capped, shall be treated as a structural part of the component and not be considered further. Where instrumentation (e.g., pressure transducer) penetrates the wall of a component or line and structural failure of the joint would result in gross leakage, the failure mode shall be considered as a failure of the component or line. The criticality of the instrumentation, therefore, would not be affected in such instances.

3. The criticality of those systems which are to be used only in the event of an emergency shall be established strictly on the basis of direct failure effect on crew, vehicle, or mission, regardless of the number of prior failures which must occur before the use of the system is required.

All other backup or standby equipment (e.g., relief valves, cross-feed valves, etc.) shall be assigned criticality in the normal manner.

#### 4.3.2 FUNCTIONAL CRITICALITY DETERMINATION

Functional criticality will be determined by the categorization of the effect on the subsystem/vehicle of loss of all redundancy (like or unlike) for the identified failure mode (See FIGURE 10). FIGURE 8 illustrates the analytical logic for criticality determination of all functional hardware.

1. Reliability Engineering identifies hardware if all like or unlike redundancy fails the effect would be critical.
2. Reliability and Design Engineering jointly identify those equipments with criticality 1R or 2R failure modes.

#### 4.3.3 CIL CONTENT CRITERIA

1. The following classification of failure modes will be entered in the CIL:
  - a. All functional/hardware criticality category 1/1's, 2/2's, and 1R2's.
  - b. All criticality category 1R3's and 2R3's that fail one or more redundancy screens.
  - c. All failure modes that become criticality category 1/1 during intact abort.
2. CIL Section 12.0 - Critical Items List orbiter modifications to support special missions:

This section of the Critical Items List contains those critical items associated with Orbiter subsystems that have been added to or modified by Orbiter Mission Kits to support special missions. These CIL items will only apply to specific vehicle missions as noted in this specific CIL subsection.

This CIL section contains the single failure points and criticality 1R and 2R CIL items identified by the Failure Mode Effects Analysis (FMEA) conducted on the Orbiter subsystems that have been added to or modified

to support special mission application. These vehicle changes are identified by individual Mission Kits which are installed specifically for these special missions and would be removed when the mission objectives have been achieved. Each vehicle change is identified by a Master Change Record (MCR) and is referenced in the applicable FMEA.

Each critical failure mode identified in the vehicle modification section is categorized on a separate Critical Items List form which includes the failure causes, effects, and rationale for retention. CIL dispositions and rationale are contained on individual CIL sheets and those that are generally applicable to all components are contained in Section 3.0.

A critical items list summary is included for each major vehicle modification. Additions will be made to this CIL section to maintain this document current with the vehicle flight configuration. CIL page revisions are indicated by revision date.

NOTE: Prior to each CIL submittal, notify the CIL coordinator of any input to CIL Section 12.0.

#### 4.3.4 MECHANICAL/ELECTRICAL INTERFACE

For mechanical components having an electrical interface, the mechanical FMEA will consider only the effects of "black box" functional failure (e.g., loss of output, premature signal, etc.). Where it becomes necessary to conduct an FMEA within the "black box" because of the assigned criticality (1 or 2), the FMEA will be conducted by Avionics Reliability who will be provided with the following information in the mechanical FMEA regarding the failure effects on the mechanical system:

- a. Enter under "CAUSE" (J380), each applicable failure mode of the electro-mechanical device reflecting the avionics malfunction causing the failure mode; i.e., loss of electrical power, premature electrical signal, etc.
- b. Identify under "REFERENCE DOCUMENTS" (C11-14), the specific mechanical/avionics interface.

The electrical interface FMEA will be included in the appropriate section of the avionics FMEA. For criticality 1, 1R, 2 or 2R failure modes, the mechanical FMEA, which considers the effect of "black box" loss of function, will indicate in the "REMARKS" section the avionics FMEA number of the "black box". The avionics FMEA of the "black box" will contain a similar reference to the appropriate mechanical FMEA. At the earliest point in time when the mechanical analyst can ascertain that the "black box" is criticality 1, 1R, 2 or 2R, it shall be his responsibility to convey to the Avionics Reliability group copies of his worksheets to facilitate initiation of detailed avionics analysis effort.

#### 4.3.5 INSTRUMENTATION FMEA'S

Instrumentation (e.g., sensors, signal conditioners, etc.) may be provided by either Avionics Instrumentation or by a specific Design group. In either case, instrumentation FMEA's will be included in the FMEA for the using subsystem. Criticality 3 instrumentation may be listed on one FMEA form by family or type. FMEA's for criticality 1 or 2 and criticality 1R and 2R instrumentation that fail a redundancy screen or the screen is "NA", will be completed in their entirety and included in the using subsystem CIL. Avionics Reliability will provide support as required to identify failure modes, retention rationale, etc.

A copy of each instrumentation FMEA completed by a Mechanical Reliability group will be provided to Avionics Reliability.

#### 4.4 SUPPLIER FMEA UTILIZATION

##### 4.4.1 GENERAL

In many instances, depending on the cost, complexity, and state of development of the design, suppliers will be required to develop and submit FMEA's reflecting their area of design responsibility. The submissions will precede the joint supplier/Rockwell PDR or CDR. (See the applicable PDRD for content requirements and submittal schedules.) FIGURE 9 shows the overall supplier FMEA flow as related to the in-house effort.

#### 4.4.2 FMEA UTILIZATION

Upon receipt of a supplier FMEA, the responsible RSA will compare the identified failure modes with those called out on his corresponding subsystem FMEA and update his FMEA as required (see section 4.2) to include any failure modes not already identified relating to subsystem effect. Supplier FMEA's will be reviewed for single failure points below the black box level by Rockwell and analyzed for corrective action directly with the supplier as part of their design review. Where Rockwell does not concur with portions of the supplier analysis, telephone contact with the supplier Reliability Engineer normally should suffice to resolve any differences. If not, the matter shall be resolved through normal Rockwell data handling procedures. Supplier black boxes will be identified in the subsystem FMEA based on the supplier schematic or drawing part identification number. For criticality 1 or 2 and 1R or 2R (CIL only) electronic black boxes, the piece parts (or if all or many circuits, so state) identified by the supplier FMEA which are single point failures that have a direct critical effect on the vehicle will be described with reference to the supplier FMEA in the "CAUSE" section of the applicable failure mode identified at the subsystem level. Parts will be listed only in those cases where less than five parts are involved.

#### 4.5 ELEMENT CONTRACTOR FMEA CORRELATION

Requirements and procedures for conducting interfacing analyses and for element integration tasks are contained in Reliability Desk Instruction 100-12 (Shuttle Element Interface).

#### 4.6 GFE

For items identified as GFE hardware, NASA will identify those which require FMEA's and will perform FMEA's on the hardware identified to the level defined by their ground rules. Upon completion of the FMEA, NASA will provide Rockwell with a copy. In addition to the completed copy, a preliminary copy may be transmitted. Upon receipt of the GFE FMEA, Rockwell will evaluate the interface effects on the Orbiter defined by the GFE FMEA.



Appropriate comments shall be included to insure that this area is correct and complete. Rockwell will conduct FMEA's for all interfaces between CFE and GFE. The Rockwell FMEA will consider all failure modes consistent with this desk instruction. The analysis is to consider as a "CAUSE" any failure mode identified by the GFE FMEA which could produce a failure in the CFE interface. Where GFE failures are identified as a "CAUSE", the appropriate GFE FMEA and document number shall be identified as a part of the "CAUSE" section. In addition, those vehicle failures which could cause FMEA failure modes will be identified to NASA in the comments to the GFE FMEA. Where structural failures are identified, appropriate hazards analyses shall be included in available.

The accountability of CIL items for GFE will be NASA. Those CIL items resulting from interface failure modes will be a part of the Rockwell CIL.

Exceptions to this instruction will be identified and concurred in jointly by Rockwell and NASA and documented as a part of letters of agreement.

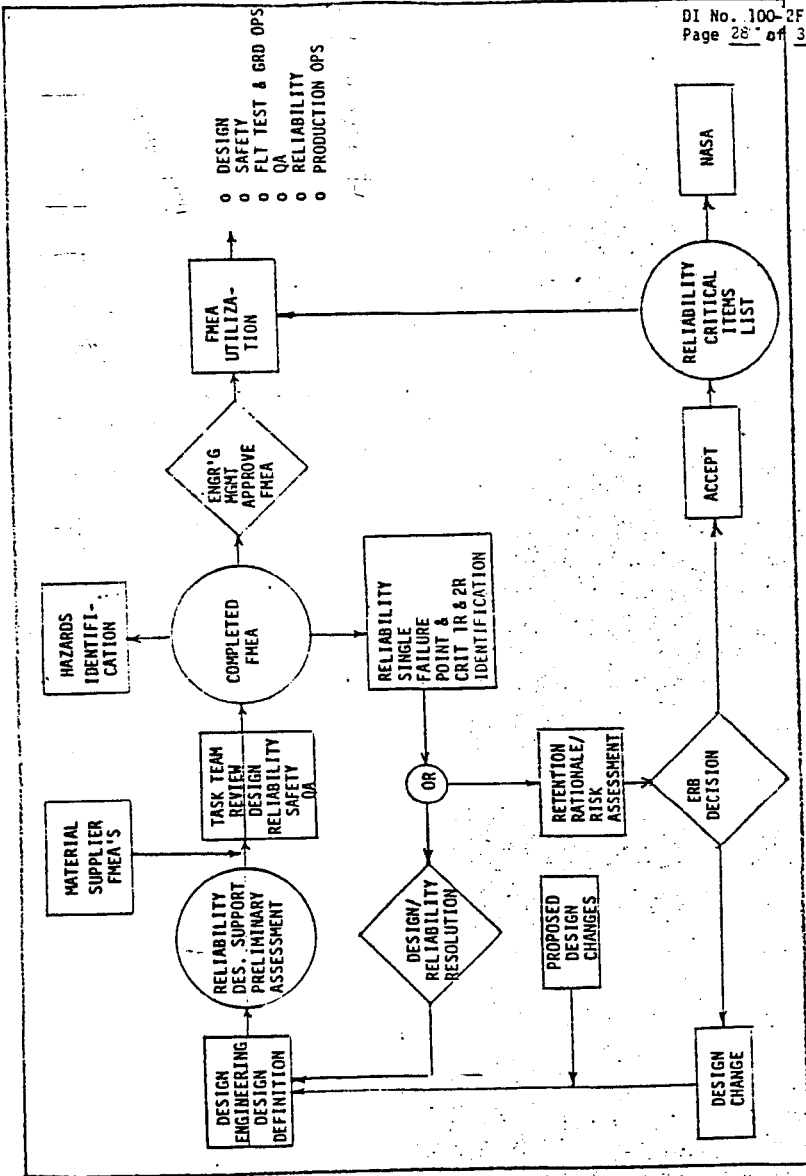

FIGURE 1 - FMEA PROCESS

**SHUTTLE FAILURE MODE AND EFFECTS ANALYSIS - ORBITER**

SUBSYSTEM : PMA NO 1 LVL - LVL - LVL ASSE  
 ASSEMBLY : C1 ASSEMBY CRIT. PMA# C27  
 P/W RI : C7 CRIT. PMA# C24  
 P/W VENDOR : C5 VEHICLA 182 SWR 100 100  
 QUANTITY : C4 EFFECTIVITY C2 C3 C5 C6  
 : C5 NUMBER OF SUCCESS PATHS REMAINING  
 : C2 AFTER FIRST FAILURE C7  
 FAILURE DETECTABLE IN FLIGHT: C40 REDUNDANCY SCHEM: B-C26 D-C26 C-C27  
 TIME TO EFFECT: C10  
 REPAIRS REQUIRED: C11  
 C12  
 C13  
 C14  
 PREPARED BY: C10 APPROVED BY: \_\_\_\_\_  
 DES: C1 REL: C1 DES: \_\_\_\_\_ REL: \_\_\_\_\_

ITEM: C2  
 J1  
 FUNCTIONS:  
 J10  
 FAILURE MODE: C31  
 J130  
 CAUSE(S):  
 J300  
 EFFECT(S):  
 J340  
 CORRECTING ACTION:  
 J400  
 HAZARD/REMARKS:  
 J500

**SHUTTLE CRITICAL ITEMS LIST - ORBITER**

SUBSYSTEM : PMA NO 1 LVL - LVL - LVL ASSE  
 ASSEMBLY : C1 ASSEMBY CRIT. PMA# C27  
 P/W RI : C7 CRIT. PMA# C24  
 P/W VENDOR : C5 VEHICLA 182 SWR 100 100  
 QUANTITY : C4 EFFECTIVITY C2 C3 C5 C6  
 : C5 NUMBER OF SUCCESS PATHS REMAINING  
 : C2 AFTER FIRST FAILURE C7  
 SRS: C23 C24 C25 C26  
 PREPARED BY: C10 APPROVED BY: \_\_\_\_\_ APPROVED BY (HAZARD): \_\_\_\_\_  
 DES: C1 REL: C1 DES: \_\_\_\_\_ REL: \_\_\_\_\_

Figure 2. FMEA

ITEM: C2  
 J1  
 FUNCTIONS:  
 J10  
 FAILURE MODE:  
 J130  
 CAUSE(S):  
 J300  
 EFFECT(S):  
 J340  
 DISPOSITION & RATIONALE:  
 J500

SHUTTLE AUTOMATED PMSA DATA SHEET NO. 1  
MASTER RECORD DATA - COMPONENT IDENTIFICATION

SEARCH KEY - P 1A, P, 01      COMPONENT IS SHIP      PART NUMBER IS SHIP

**ASSEMBLY**  
 C1 \_\_\_\_\_  
 C2 \_\_\_\_\_  
 C3 \_\_\_\_\_  
 C4 \_\_\_\_\_  
 C5 \_\_\_\_\_  
 C6 \_\_\_\_\_  
 C7 \_\_\_\_\_  
 C8 \_\_\_\_\_  
 C9 \_\_\_\_\_  
 C10 \_\_\_\_\_

**UNIT GROUPS**  
 C1 \_\_\_\_\_  
 C2 \_\_\_\_\_  
 C3 \_\_\_\_\_  
 C4 \_\_\_\_\_  
 C5 \_\_\_\_\_  
 C6 \_\_\_\_\_  
 C7 \_\_\_\_\_  
 C8 \_\_\_\_\_  
 C9 \_\_\_\_\_  
 C10 \_\_\_\_\_

**RELEASES/REWORKS**  
 C1 \_\_\_\_\_  
 C2 \_\_\_\_\_  
 C3 \_\_\_\_\_  
 C4 \_\_\_\_\_  
 C5 \_\_\_\_\_  
 C6 \_\_\_\_\_  
 C7 \_\_\_\_\_  
 C8 \_\_\_\_\_  
 C9 \_\_\_\_\_  
 C10 \_\_\_\_\_

**UNIT GROUPS**  
 C1 \_\_\_\_\_  
 C2 \_\_\_\_\_  
 C3 \_\_\_\_\_  
 C4 \_\_\_\_\_  
 C5 \_\_\_\_\_  
 C6 \_\_\_\_\_  
 C7 \_\_\_\_\_  
 C8 \_\_\_\_\_  
 C9 \_\_\_\_\_  
 C10 \_\_\_\_\_

**RELEASES/REWORKS**  
 C1 \_\_\_\_\_  
 C2 \_\_\_\_\_  
 C3 \_\_\_\_\_  
 C4 \_\_\_\_\_  
 C5 \_\_\_\_\_  
 C6 \_\_\_\_\_  
 C7 \_\_\_\_\_  
 C8 \_\_\_\_\_  
 C9 \_\_\_\_\_  
 C10 \_\_\_\_\_

Figure 4. Data Sheet No. 1

SHUTTLE AUTOMATED PMSA DATA SHEET NO. 2  
SUPPORTING RECORD DATA - FAILURE MODE, CAUSE AND EFFECT

SEARCH KEY - P 1A, P, 01      COMPONENT IS SHIP      PART NUMBER IS SHIP

**FAILURE MODES**  
 J130 \_\_\_\_\_  
 J140 \_\_\_\_\_  
 J150 \_\_\_\_\_  
 J160 \_\_\_\_\_  
 J170 \_\_\_\_\_  
 J180 \_\_\_\_\_  
 J190 \_\_\_\_\_  
 J200 \_\_\_\_\_

**FAILURE CAUSES**  
 C1 \_\_\_\_\_  
 C2 \_\_\_\_\_  
 C3 \_\_\_\_\_  
 C4 \_\_\_\_\_  
 C5 \_\_\_\_\_  
 C6 \_\_\_\_\_  
 C7 \_\_\_\_\_  
 C8 \_\_\_\_\_  
 C9 \_\_\_\_\_  
 C10 \_\_\_\_\_

**FAILURE EFFECTS**  
 E1 \_\_\_\_\_  
 E2 \_\_\_\_\_  
 E3 \_\_\_\_\_  
 E4 \_\_\_\_\_  
 E5 \_\_\_\_\_  
 E6 \_\_\_\_\_  
 E7 \_\_\_\_\_  
 E8 \_\_\_\_\_  
 E9 \_\_\_\_\_  
 E10 \_\_\_\_\_

**FAILURE MODES**  
 J130 \_\_\_\_\_  
 J140 \_\_\_\_\_  
 J150 \_\_\_\_\_  
 J160 \_\_\_\_\_  
 J170 \_\_\_\_\_  
 J180 \_\_\_\_\_  
 J190 \_\_\_\_\_  
 J200 \_\_\_\_\_

**FAILURE CAUSES**  
 C1 \_\_\_\_\_  
 C2 \_\_\_\_\_  
 C3 \_\_\_\_\_  
 C4 \_\_\_\_\_  
 C5 \_\_\_\_\_  
 C6 \_\_\_\_\_  
 C7 \_\_\_\_\_  
 C8 \_\_\_\_\_  
 C9 \_\_\_\_\_  
 C10 \_\_\_\_\_

**FAILURE EFFECTS**  
 E1 \_\_\_\_\_  
 E2 \_\_\_\_\_  
 E3 \_\_\_\_\_  
 E4 \_\_\_\_\_  
 E5 \_\_\_\_\_  
 E6 \_\_\_\_\_  
 E7 \_\_\_\_\_  
 E8 \_\_\_\_\_  
 E9 \_\_\_\_\_  
 E10 \_\_\_\_\_

**VEHICLE EFFECTIVITY**  
 J02 \_\_\_\_\_ C01   
 J03 \_\_\_\_\_ C02   
 J04 \_\_\_\_\_ C03   
 J05 \_\_\_\_\_ C04   
 J06 \_\_\_\_\_ C05   
 J07 \_\_\_\_\_ C06   
 J08 \_\_\_\_\_ C07   
 J09 \_\_\_\_\_ C08   
 J10 \_\_\_\_\_ C09   
 J11 \_\_\_\_\_ C10

**FAILURE MODES**  
 J130 \_\_\_\_\_  
 J140 \_\_\_\_\_  
 J150 \_\_\_\_\_  
 J160 \_\_\_\_\_  
 J170 \_\_\_\_\_  
 J180 \_\_\_\_\_  
 J190 \_\_\_\_\_  
 J200 \_\_\_\_\_

**FAILURE CAUSES**  
 C1 \_\_\_\_\_  
 C2 \_\_\_\_\_  
 C3 \_\_\_\_\_  
 C4 \_\_\_\_\_  
 C5 \_\_\_\_\_  
 C6 \_\_\_\_\_  
 C7 \_\_\_\_\_  
 C8 \_\_\_\_\_  
 C9 \_\_\_\_\_  
 C10 \_\_\_\_\_

**FAILURE EFFECTS**  
 E1 \_\_\_\_\_  
 E2 \_\_\_\_\_  
 E3 \_\_\_\_\_  
 E4 \_\_\_\_\_  
 E5 \_\_\_\_\_  
 E6 \_\_\_\_\_  
 E7 \_\_\_\_\_  
 E8 \_\_\_\_\_  
 E9 \_\_\_\_\_  
 E10 \_\_\_\_\_

**NUMBER OF TIMES FAILURE OCCURRED AFTER FIRST FAILURE** CTF

**REWORKS/REPAIRS** C1 (N/A)  
 1 - C1P, P1    2 - C1P, P1    3 - C1P, P1

**CRITICAL ITEMS LIST**

**CRITICALITY**  
 PMS: 01  
 MS: C1

Figure 5. Data Sheet No. 2

REPORT NO. 01		UNIT'S AUTOMATIC DATA MONITORING		UNIT'S OPERATOR	
SUBSYSTEM LEVEL		COMPONENT LEVEL		C	
SUBSYSTEMS					
ASSEMBLY	CODE				
ITEMS CODE					
J001					
J002					
J003					
FUNCTIONS					
J010					
J011					
J012					
J013					
J014					
J015					
J016					
J017					
J018					
J019					
J020					
QUANTITIES CODE					
CODE	CODE	C		PART NUMBER	CODE
CODE			C	CODE	
REFERENCE DOCUMENTS					
CODE				DATA PREPARATION	CODE
CODE				INSTALLATION	CODE
CODE				MAINTENANCE	CODE

Figure 6. Data Printout, Component-Related Data

REPORT NO. 01		UNIT'S AUTOMATIC DATA MONITORING		UNIT'S OPERATOR	
SUBSYSTEM LEVEL		COMPONENT LEVEL		C	
SUPPLEMENTAL RECORD DATA - FAILURE MODES, CAUSES AND EFFECTS					
FAILURE MODES	CODE		CODE	FAILURE EFFECTS	CAUSE
J100					
J101					
J102					
J103					
J104					
J105					
J106					
J107					
J108					
J109					
J110					
J111					
J112					
J113					
J114					
J115					
J116					
J117					
J118					
J119					
J120					
J121					
J122					
J123					
J124					
J125					
J126					
J127					
J128					
J129					
J130					
J131					
J132					
J133					
J134					
J135					
J136					
J137					
J138					
J139					
J140					
J141					
J142					
J143					
J144					
J145					
J146					
J147					
J148					
J149					
J150					
J151					
J152					
J153					
J154					
J155					
J156					
J157					
J158					
J159					
J160					
J161					
J162					
J163					
J164					
J165					
J166					
J167					
J168					
J169					
J170					
J171					
J172					
J173					
J174					
J175					
J176					
J177					
J178					
J179					
J180					
J181					
J182					
J183					
J184					
J185					
J186					
J187					
J188					
J189					
J190					
J191					
J192					
J193					
J194					
J195					
J196					
J197					
J198					
J199					
J200					

Figure 7. Data Printout, Failure Mode-Related Data

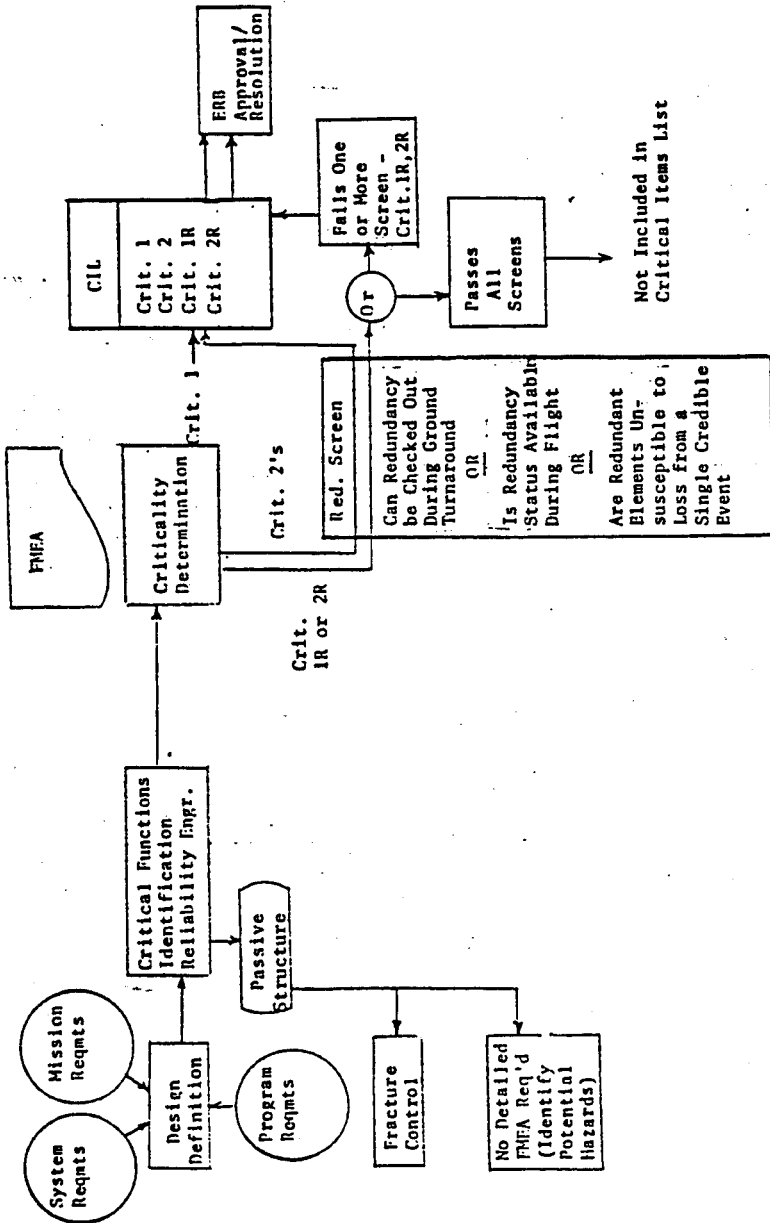
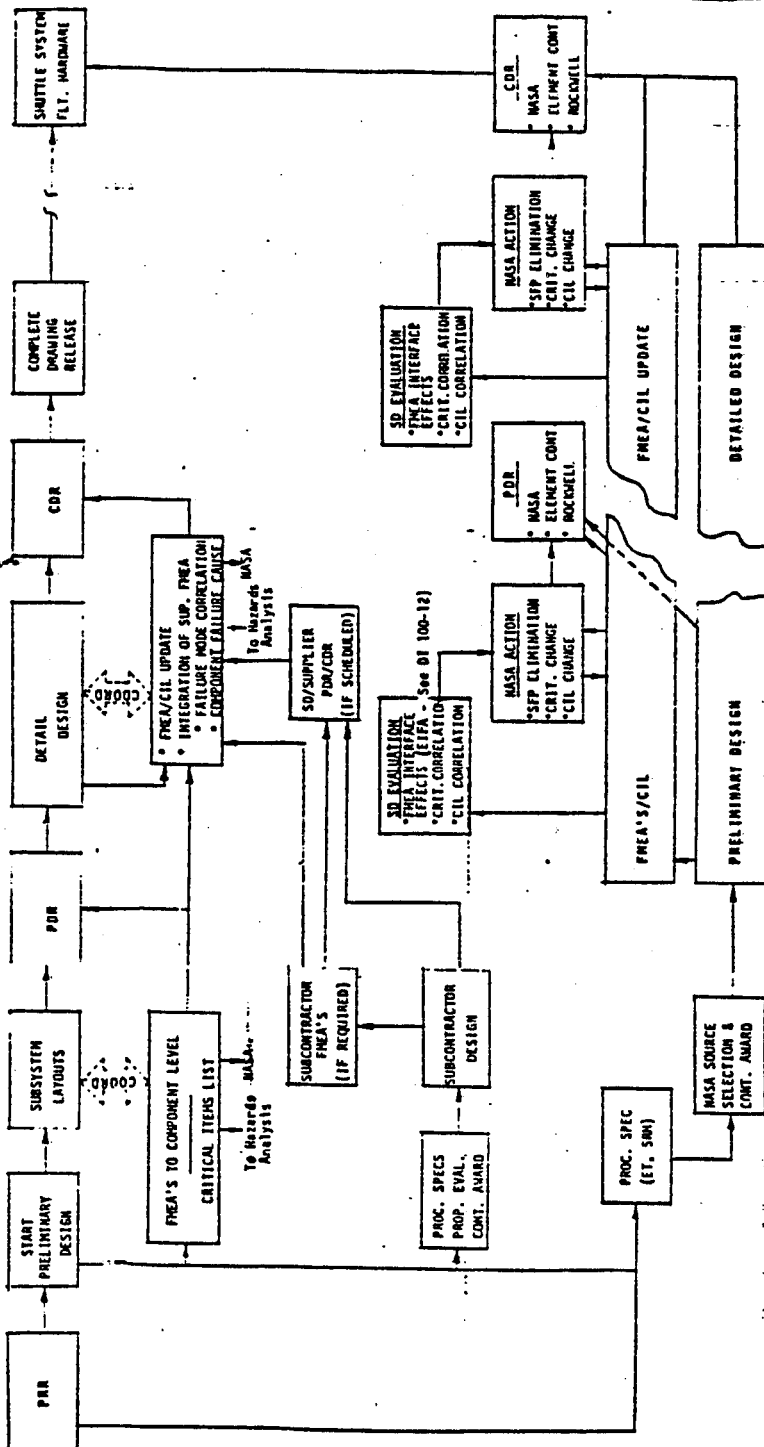

FIGURE 8 - FMEA SCREENING

Figure 9 - FMEA FLOW



CRITICALITY CATEGORY  
CROSS REFERENCE TABLE

DI No. 100-2F  
Page 34 of 34

FUNCTION / LEVEL OF REDUNDANCY	BLOCK DIAGRAM	CRITICALITY CATEGORY		
		FUNCTIONAL DEFINITIONS	HARDWARE DEFINITIONS	
LIFE OR VEHICLE ESSENTIAL / NO REDUNDANCY		1 (CIL)	1 (CIL)	
MISSION ESSENTIAL / NO REDUNDANCY		2 (CIL)	2 (CIL)	
LIFE OR VEHICLE ESSENTIAL / DUAL REDUNDANCY		1R (CIL)	2 (CIL)	
MISSION ESSENTIAL / DUAL REDUNDANCY		PASSED SCREEN	FAILED SCREEN	3
		2R	2R (CIL)	
LIFE OR VEHICLE ESSENTIAL / TRIPLE REDUNDANCY		1R	1R (CIL)	3
MISSION ESSENTIAL / TRIPLE REDUNDANCY		2R	2R (CIL)	3
ALL NON-ESSENTIAL / ALL LEVELS OF REDUNDANCY		3		3

FIGURE 10



FAILURE EFFECTS

- (A) ON FUNCTION OR SUBSYSTEM:
- No Effect
  - Loss of Redundancy
  - Functional Degradation
  - Subsystem Degradation
  - Loss of Function
  - Loss of Subsystem
- (B) ON INTERFACE FUNCTIONS OR SUBSYSTEMS:
- No Effect
  - Loss of Interface Redundancy
  - Degradation of Interface Function
  - Degradation of Interface Subsystem
  - Loss of Interface Function
  - Loss of Subsystem
- (C) ON MISSION:
- No Effect
  - See Note Below for Criticality 2 Modes
  - Mission Modification
  - Loss of Entry Capability - Rescue
- (D) ON CREW/VEHICLE:
- No Effect
  - Possible Loss of Crew/Vehicle (Specify)
  - Probable Loss of Crew/Vehicle (Conditions)
  - Loss of Crew/Vehicle

NOTE: The following instruction is intended to clarify what should be entered in the FMEA/CIL under "EFFECTS ON MISSION" (item C under entry J240) for identified criticality 2 failure modes.

Criticality 2 failure (modes) are defined as: (1) single failures which would cause "loss of mission", and (2) failures wherein the next associated failure would cause loss of crew/vehicle (Appendix B, Section 3.1.1, Ground Rules, subparagraph 1).

The following chart (Mission Effects - Criticality 2 Failure Modes) is included as a guideline for entries under "EFFECTS ON MISSION". The term "abort decision" should only be used where there really is a decision. :

MISSION EFFECTS - CRITICALITY 2 FAILURE MODES

ENTRIES UNDER "EFFECTS ON MISSION" IN FMEA/CIL FOR CRITICALITY 2 FAILURE MODES	RATIONALE/TYPICAL SITUATIONS AND EXAMPLES (GUIDELINES NOT TO BE ENTERED IN FMEA/CIL)
1. LOSS OF CAPABILITY TO - - - (ADD SPECIFICS OF CAPABILITY LOST DUE TO IDENTIFIED FAILURE).	FAILURE MODE AFFECTS ACCOMPLISHMENT OF MISSION OBJECTIVE(S) ONLY. EXAMPLE: JAWED GEAR BOX (SFP) WHICH PRECLUDES RELEASE OR DEPLOYMENT OF A PAYLOAD.
2. ABORT DECISION IF FAILURE OCCURS PRIOR TO ENTRY COMMITMENT.	LOSS OF REDUNDANCY WHEREIN NEXT ASSOCIATED FAILURE WILL CAUSE LOSS OF CREW/VEHICLE. EXAMPLES: APU/HVD, ECLSS FUNCTIONS, POWER GENERATION.
3. NONE - REDUNDANT SIMULTANEOUS MEANS AVAILABLE TO - - - (SPECIFY FUNCTION TO BE PERFORMED.)	SIMULTANEOUS USAGE OF REDUNDANT MEANS TO PERFORM A TIME CRITICAL FUNCTION. EXAMPLE: FAILURE OF ONE OF TWO REDUNDANT PYROTECHNIC DEVICES IN THE SEPARATION SYSTEM.
4. CONTINUE MISSION - DUTY CYCLE SAME AS ABORT.	EXAMPLE: LOSS OF ONE MOTOR WHILE OPENING A DOOR WHICH SUBSEQUENTLY MUST BE CLOSED FOR ENTRY.
NOTE: WHEN DECISION IS TIME DEPENDENT:	
5. ABORT AOA OR ATO IF FAILURE OCCURS DURING ASCENT PHASE.	LOSS OF ONE OWS ENGINE PRECLUDES MISSION COMPLETION.
6. ABORT UNLESS MISSION CAN BE COMPLETED WITH ONE SSHE OUT.	MISSION 1 CAN BE COMPLETED IF ONE SSHE SHUTS DOWN BETWEEN 347.3 AND 401.9 SECONDS OF ASCENT. MISSION 2 HAS NO ENGINE OUT MISSION COMPLETION CAPABILITY.

### 3.0 GROUND RULES AND CRITERIA

The following ground rules and criteria are of a general category for guidance, as applicable, in conducting and interpreting an FMEA. The applicable ground rules and criteria will be a part of the information which prefaces each FMEA. (See section 3.2, FMEA Content.)

#### 3.1 GENERAL GROUND RULES AND CRITERIA

##### 3.1.1 GROUND RULES

1. Criticality definitions are those delineated in NHB 5300.4 (1D-1), as illustrated in FIGURE 10 (Criticality Category Cross Reference Table). For the purpose of this analysis, hardware criticality 2 is further defined; i.e., dual redundancy where:
  - a. The first failure would result in loss of mission.
  - b. The next related failure would result in loss of life/vehicle.
2. Criticality 1R and 2R assumes failure of all like and unlike redundancy: A backup item, if when it is called upon to work, performs a function different from the item it is backing up, it should be classified based upon the effect if it does not work when operated. If the backup item performs the same function as the item it is backing up, the backup should be classified as an unlike redundant item.
3. Loss of mission is defined as follows:
  - a. Operation payload interface hardware failure as it would result in loss of payload primary performance.
  - b. Orbiter subsystem failure as it would result in unplanned mission termination for non-safety of flight reasons.
4. Categorization of a hardware item by the worst case potential effect of failure of that item will define criticality.
5. Failure modes that could propagate to interfacing subsystems or experiments will be identified.

6. When defining FMEA's/CIL for a particular subsystem, interfacing subsystems will be considered to be operating within their specified tolerances.
7. GFE FMEA data will be utilized in evaluating the GFE/Rockwell International interfaces for the vehicle FMEA and CIL.
8. Failure detectability assumes the availability of telemetry or a crewman responding to monitored displays. Failure detectability also assumes other means of failure detection, where feasible, such as a crew response to physical stimuli; i.e., smell, sound, etc.
9. Specific FMEA criteria and assumptions will be defined for each subsystem.
10. Identical components used for different functions will be treated separately in the FMEA.
11. Simultaneous failure of redundant components is identified where the failure cause encompasses both components.
12. Subsystem analysis will include an evaluation of the effects of instrumentation failure upon/within the subsystem.
13. External Leakage:
  - a. The external leakage mode of functional hardware items from any source (except mating of two surfaces by welding, brazing, or permaswage) will be considered. If this mode raises the criticality of the items in question, it will be documented and the potential leak source identified under "CAUSE(S)". Otherwise, the external leakage will be treated generically by media. However, in those instances where external leakage results in a hardware criticality 1 effect, the failure mode will be documented regardless of the basic criticality of the item being considered. Where applicable, seal failure should be listed as a cause and worst case (complete seal failure) shall be assumed, considering

also any restrictive protection provided by barrier design, where such data are available from Design. Hazards associated with the loss of fluid in excess of requirements will be documented and covered by Hazard Analysis, but will not affect criticality (see section 3.3, paragraph 4.)

- b. The internal leak mode of functional hardware items will be considered. In those instances where internal leakage could result in a hardware criticality 1 or 2 failure mode effect (fail open or fail closed due to pressure lockup), "internal leakage" shall be entered in the "CAUSE" section of the most appropriate identified failure mode entry in lieu of "cause" is acceptable.
  - c. Where external or internal leak paths are protected by static or dynamic redundant (verifiable) seals, the leak path effect will be reduced by one criticality level.
  - d. Pressure carriers (lines, pressure vessels) will be classified by worst case mode including external leakage. Lines will be entered generically for each independent media. Special lines (i.e., mechanical bellows, flex lines, etc.) will be entered individually. Tanks will be entered individually.
14. The failure of any tank containing fluid media which, due to its location in an enclosed vehicle compartment, could cause compartment overpressurization leading to structural failure (vehicle loss) will be classified hardware criticality 1 for tank rupture mode.
15. All lines will be designated the criticality applicable to the functional loss effect resulting from loss of medium with notation in the "REMARKS" section of the FMEA as to the potential hazard due to compartment overpressurization resulting from line rupture. The main engine cryogenic feedlines will be treated as fluid tanks.

### 3.1.2 CRITERIA

1. The FMEA and CIL will consider failures beginning with preflight/pre-launch operations through post landing safings at Edwards Air Force Base/Kennedy Space Center (EAFB/KSC).
  - a. Prelaunch operations at KSC/VAFB are defined as beginning with propellant loading for each specific propulsion subsystem. For all other subsystems, prelaunch operations commence with start of main engine conditioning.
  - b. Post landing safing operations include those activities performed after landing to prepare the orbiter for hangar operations and are defined as follows:
    - (1) Deservice and draining of hazardous fluids.
    - (2) Safing of unused ordnance.
    - (3) Application of ground power and cooling.
    - (4) Removal of potentially hazardous components.
    - (5) Removal of pods and payloads.
    - (6) Purging and venting of gases.
    - (7) Installation of protective covers.
2. Redundancy is defined as the use of more than one means of accomplishing a given task or function where all must fail before there is an overall failure of the function.
  - a. Operational Redundancy - redundant elements, all of which are fully energized during the subsystem operating cycle. Operational redundancy includes load sharing redundancy wherein redundant elements are connected in such a manner that, upon failure of one unit, the remaining redundant elements will continue to perform the subsystem function. It is not necessary to switch out the failed element nor to switch in the redundant element.
  - b. Standby Redundancy - redundant elements that are non-operative (i.e., have no power applied) until they are switched into the subsystem upon failure of the primary element. In these cases, as well as pyrotechnic devices, mechanical linkage and inoperative

functional paths of any subsystem, redundancy screen B is considered not applicable and so marked. This approach is based on the fact that these areas are subject to ground checkout; they are redundant and therefore provide a degree of protection in flight; it is confirmed that when called upon to operate, the inability to operate would be detected in flight for appropriate corrective action.

3. Where redundancy exists in the subsystem, the redundancy is considered during the analysis of a failure of the component.
4. "Alternate means of operation" refers to accomplishment of a function and not necessarily to redundancy or restoration of a failed function.
5. When fire hazards resulting from short circuits or other hardware failure modes are identified, consideration will be given to the effect of fire propagation to adjacent redundant equipment as a potential loss of the function.

Potential safety concerns created by component failure modes will be identified and handled through Hazards Analyses as required by EOM 70 1-4.2.5 and by NHB 5300.4 (1D-1).

6. Reference documents in the FMEA include released and controlled engineering drawings or specifications, when available.
7. The following are used as aids in determining the failure modes and causes of subsystem hardware failures:
  - a. Generic failure modes and causes.
  - b. Released and controlled component, assembly, and detail engineering drawings and specifications.
  - c. Training aids, as available; e.g., cross section drawings, photographs, exploded drawings (not referenced in FMEA).
  - d. Actual hardware, if available.
  - e. Use experience, including failure history and similar components.

- f. Controlled and released operational procedures.
  - g. Component FMEA's prepared by component suppliers.
8. Failure of structural items (primary and secondary) will not be considered as a part of this analysis. (Structural items are assumed to be designed to preclude failure by use of adequate design safety factors.)
9. FMEA's of criticality 1 or 2 "black boxes" providing electrical signal interface to mechanical components are included in the applicable avionics FMEA package with appropriate cross-referencing in the "REFERENCE DOCUMENTS" section of both the appropriate avionics and mechanical FMEA report, where available.
10. The failure mode "Fails to Operate" will not be addressed for fuses. Use of a fuse with a higher current capacity than specified (wrong size installed or rating misidentified) is not considered a fuse failure mode.



## VII-A



Designation: D 395 - 85

AMERICAN SOCIETY FOR TESTING AND MATERIALS  
1916 Race St., Philadelphia, Pa. 19103

Reprinted from the Annual Book of ASTM Standards, Copyright ASTM  
If not listed in the current combined index, will appear in the next edition.

## Standard Test Methods for RUBBER PROPERTY—COMPRESSION SET<sup>1</sup>

This standard is issued under the fixed designation D 395; the number immediately following the designation indicates the year of original adoption or, in the case of revision, the year of last revision. A number in parentheses indicates the year of last reapproval. A superscript epsilon ( $\epsilon$ ) indicates an editorial change since the last revision or reapproval.

*These methods have been approved for use by agencies of the Department of Defense and for listing in the DoD Index of Specifications and Standards.*

### 1. Scope

1.1 These test methods cover the testing of rubber intended for use in applications in which the rubber will be subjected to compressive stresses in air or liquid media. They are applicable particularly to the rubber used in machinery mountings, vibration dampers, and seals. Two methods are covered as follows:

Method	Section
A—Compression Set Under Constant Force in Air	7-10
B—Compression Set Under Constant Deflection in Air	11-14

1.2 The choice of method is optional, but consideration should be given to the nature of the service for which correlation of test results may be sought. Unless otherwise stated in a detailed specification, Method B shall be used.

1.3 Method B is not suitable for vulcanizates harder than 90 IRHD.

1.4 The values stated in SI units are to be regarded as the standard.

1.5 *This standard may involve hazardous materials, operations, and equipment. This standard does not purport to address all of the safety problems associated with its use. It is the responsibility of whoever uses this standard to consult and establish appropriate safety and health practices and determine the applicability of regulatory limitations prior to use.*

### 2. Applicable Documents

#### 2.1 ASTM Standards:

- D 1349 Practice for Rubber—Standard Temperatures and Atmospheres for Testing and Conditioning<sup>2</sup>
- D 3040 Practice for Preparing Precision State-

ments for Standards Related to Rubber and Rubber Testing<sup>2</sup>

D 3182 Practice for Rubber—Materials, Equipment, and Procedures for Mixing Standard Compounds and Preparing Standard Vulcanized Sheets<sup>3</sup>

D 3183 Practice for Rubber—Preparation of Pieces for Test Purposes from Products<sup>3</sup>

D 3767 Practice for Rubber—Measurement of Dimensions<sup>3</sup>

E 145 Specification for Gravity-Convection and Forced-Ventilation Ovens<sup>4</sup>

NOTE 1—The specific dated edition of Practice D 3040 that prevails in this document is referenced in the Precision section.

### 3. Summary of Methods

3.1 A test specimen is compressed to either a deflection or by a specified force and maintained under this condition for a specified time and at a specified temperature.

3.2 The residual deformation of a test specimen is measured 30 min after removal from a suitable compression device in which the specimen had been subjected for a definite time to compressive deformation under specified conditions.

3.3 After the measurement of the residual deformation, the compression set as specified in the

<sup>1</sup> These test methods are under the jurisdiction of ASTM Committee D-11 on Rubber and are the direct responsibility of Subcommittee D11.10 on Physical Testing.

Current edition approved Sept. 27, 1985. Published November 1985. Originally published as D 395 - 34. Last previous edition D 395 - 84.

<sup>2</sup> Annual Book of ASTM Standards, Vols 09.01 and 09.02.

<sup>3</sup> Annual Book of ASTM Standards, Vol 09.01.

<sup>4</sup> Annual Book of ASTM Standards, Vol 14.02.

appropriate method, is calculated according to Eqs (1) and (2).

#### 4. Significance and Use

4.1 Compression set tests are intended to measure the ability of rubber compounds to retain elastic properties after prolonged action of compressive stresses. The actual stressing service may involve the maintenance of a definite deflection, the constant application of a known force, or the rapidly repeated deformation and recovery resulting from intermittent compressive forces. Though the latter dynamic stressing, like the others, produces compression set, its effects as a whole are simulated more closely by compression flexing or hysteresis tests. Therefore, compression set tests are considered to be mainly applicable to service conditions involving static stresses. Tests are frequently conducted at elevated temperatures.

#### 5. Test Specimens

5.1 Specimens from each sample may be tested in duplicate (Option 1) or triplicate (Option 2). The compression set of the sample in Option 1 shall be the average of the two specimens, expressed as a percentage. The compression set of the sample in Option 2 shall be the median (middle most value) of the three specimens expressed as a percentage.

5.2 The standard test specimen shall be a cylindrical disk cut from a laboratory prepared slab.

5.2.1 The dimensions of the standard specimens shall be:

Type	1 <sup>a</sup>	2 <sup>b</sup>
Thickness, mm (in.)	12.5 ± 0.5 (0.49 ± 0.02)	6.0 ± 0.2 (0.24 ± 0.01)
Diameter, mm (in.)	29.0 ± 0.5 (1.14 ± 0.02)	13.0 ± 0.2 (0.51 ± 0.01)

<sup>a</sup> Type 1 specimen is used in Methods A and B.

<sup>b</sup> Type 2 specimen is used in Method B.

5.2.2 When cutting the standard specimen, the circular die having the required inside dimensions specified in 5.2.1 shall be rotated in a drill press or similar device and lubricated by means of a soap solution. A minimum distance of 13 mm (0.51 in.) shall be maintained between the cutting edge of the die and the edge of the slab. The cutting pressure shall be as light as possible to minimize cupping of the cut edges. The dies shall be maintained carefully so that the cutting edges are sharp and free of nicks.

5.3 An optional method of preparing the standard specimen may be the direct molding of a circular disk having the dimensions required for the method used and specified in 5.2.1.

NOTE 2—It should be recognized that an equal time and temperature, if used for both the slab and molded specimen, will not produce an equivalent state of cure in the two types of specimen. A higher degree of cure will be obtained in the molded specimen. Adjustments, preferably in the time of cure, must be taken into consideration if comparisons between the specimens prepared by different methods are to be considered valid.

NOTE 3—It is suggested, for the purpose of uniformity and closer tolerances in the molded specimen, that the dimensions of the mold be specified and shrinkage compensated for therein. A two-plate mold with a cavity 13.0 ± 0.1 mm (0.510 ± 0.004 in.) in thickness and 29.20 ± 0.05 mm (1.148 ± 0.002 in.) in diameter, with overflow grooves will provide Type 1 specimens for Method A and Method B. A similar mold but having a cavity of 6.3 ± 0.3 mm (0.25 ± 0.012 in.) in thickness and 13.2 ± 0.1 mm (0.52 ± 0.004 in.) in diameter will provide Type 2 specimens for Method B.

5.4 When the standard test specimen is to be replaced by a specimen taken from a vulcanized rubber part of greater thickness than the one indicated in 5.2.1, the sample thickness shall be reduced first by cutting transversely with a sharp knife and then followed by buffing to the required thickness in accordance with Practice D 3183.

5.5 An alternative method of preparing specimens is by plying up cylindrical disks cut from a standard sheet prepared in accordance with Practice D 3182 using the specimen sizes specified in 5.2.1 and cutting as described in 5.2.2.

5.5.1 The disks shall be plied, without cementing, to the thickness required. Such plies shall be smooth, flat, of uniform thickness, and shall not exceed seven in number for Type 1 specimens and four in number for Type 2 specimens.

5.5.2 Care shall be taken during handling and placing of the plied test specimen in the test fixture by keeping the circular faces parallel and at right angles to the axis of the cylinder.

5.5.3 The results obtained on plied specimens may be different from those obtained using solid specimens and the results may be variable, particularly if air is trapped between disks.

5.5.4 The results obtained on the specimens prepared by one of the methods may be compared only to those prepared by the same method.

5.6 For routine or product specification test-

 D 395

ing, it is sometimes more convenient to prepare specimens of a different size or shape, or both. When such specimens are used, the results should be compared only with those obtained from specimens of similar size and shape and not with those obtained with standard specimen. For such cases, the product specification should define the specimen as to the size and shape. If suitable specimens cannot be prepared from the product, the test method and allowable limits must be agreed upon between the producer and the purchaser.

## 6. Conditioning

6.1 Store all vulcanized test specimens or product samples to be tested at least 24 h but not more than 60 days. When the date of vulcanization is not known, make tests within 60 days after delivery by the producer of the article represented by the specimen.

6.2 Allow buffed specimens to rest at least 30 min before specimens are cut for testing.

6.3 Condition all specimens before testing for a minimum of 3 h at  $23 \pm 2^\circ\text{C}$  ( $73.4 \pm 3.6^\circ\text{F}$ ). Specimens whose compression set properties are affected by atmospheric moisture, shall be conditioned for a minimum of 24 h in an atmosphere controlled to  $50 \pm 5\%$  relative humidity.

### METHOD A—COMPRESSION SET UNDER CONSTANT FORCE IN AIR

## 7. Apparatus

7.1 *Dial Micrometer*—A dial micrometer, for measuring specimen thickness, in accordance with Practice 3767, Method A1.

7.2 *Compression Device*, consisting of a force application spring and two parallel compression plates assembled by means of a frame or threaded bolt in such a manner that the device shall be portable and self-contained after the force has been applied and that the parallelism of the plates shall be maintained. The force may be applied in accordance with either 7.2.1 or 7.2.2.

7.2.1 *Calibrated Spring Force Application*—The required force shall be applied by a screw mechanism for compressing a calibrated spring the proper amount. The spring shall be of properly heat-treated spring steel with ends ground and perpendicular to the longitudinal axis of the spring. A suitable compression device is shown in Fig. 1. The spring shall conform to the following requirements:

7.2.1.1 The spring shall be calibrated at room temperature  $23 \pm 5^\circ\text{C}$  ( $73.4 \pm 9^\circ\text{F}$ ) by applying successive increments of force not exceeding 250 N (50 lbf) and measuring the corresponding deflection to the nearest 0.2 mm (0.01 in.). The curve obtained by plotting the forces against the corresponding deflections shall have a slope of  $70 \pm 3.5\text{ kN/m}$  ( $400 \pm 20\text{ lbf/in.}$ ) at 1.8 kN (400 lbf). The slope is obtained by dividing the two forces above and below 1.8 kN by the difference between the corresponding deflections.

7.2.1.2 The original dimensions of the spring shall not change due to fatigue by more than 0.3 mm (0.01 in.) after it has been mounted in the compression device, compressed under a force of 1.8 kN (400 lbf), and heated in the oven for one week at  $70^\circ\text{C} \pm 2^\circ\text{C}$  ( $158 \pm 3.6^\circ\text{F}$ ). In ordinary use, a weekly check of the dimensions shall show no greater change than this over a period of 1 year.

7.2.1.3 The minimum force required to close the spring (solid) shall be 2.4 kN (530 lbf).

7.2.2 *External Force Application*—The required force shall be applied to the compression plates and spring by external means after the test specimen is mounted in the apparatus. Either a calibrated compression machine or known masses may be used for force application. Provision shall be made by the use of bolts and nuts or other devices to prevent the specimen and spring from losing their initial deflections when the external force is removed. The spring shall have essentially the same characteristics as described in 7.2.1, but calibration is not required. A suitable compression device is shown in Fig. 2.

7.3 *Plates*—The plates between which the test specimen is compressed shall be made of steel of sufficient thickness to withstand the compressive stresses without bending. The surfaces against which the specimen is held shall have a highly polished chromium-plated finish and shall be cleaned thoroughly and wiped dry before each test.

7.4 *Oven*, conforming to the specification for a Type IIB laboratory oven given in Specification E 145.

## 8. Procedure

8.1 *Original Thickness Measurement*—Measure the original thickness of the specimen to the nearest 0.02 mm (0.001 in.). Place the specimen

 **D 395**

on the anvil of the dial micrometer so that the presser foot will indicate the thickness at the central portion of the top and bottom faces.

**8.2 Application of Compressive Force**—Assemble the specimens in the compression device, using extreme care to place them exactly in the center between the plates to avoid tilting. If the calibrated spring device (Fig. 1) is used, apply the compressive force by tightening the screw until the deflection as read from the scale is equivalent to that shown on the calibration curve for the spring corresponding to a force of 1.8 kN (400 lbf). With the external loading device (Fig. 2), apply this force to the assembly in the compression machine or by adding required masses, but in the latter case, take care to add the mass gradually without shock. Tighten the nuts and bolts just sufficiently to hold the initial deflections of the specimen and spring. It is imperative that no additional force be applied in tightening the bolts.

**8.3 Test Time and Test Temperature**—Choose a suitable temperature and time for the compression set, depending upon the conditions of the expected service. In comparative tests, use identical temperature and heating periods. It is suggested that the test temperature be chosen from those listed in Practice D 1349. Suggested test periods are 22 h and 70 h. The specimen shall be at room temperature when inserted in the compression device. Place the assembled compression device in the oven within 2 h after completion of the assembly and allow it to remain there for the required test period in dry air at the test temperature selected. At the end of the test period, take the device from the oven and remove the specimens immediately and allow it to cool.

**8.4 Cooling Period**—While cooling, allow the specimens to rest on a poor thermally conducting surface, such as wood, for 30 min before making the measurement of the final thickness. Conduct the cooling period at a standard laboratory temperature of  $23 \pm 2^\circ\text{C}$  ( $73.4 \pm 3.6^\circ\text{F}$ ). Specimens whose compression set property is affected by atmospheric moisture shall be cooled in an atmosphere controlled to  $50 \pm 5\%$  relative humidity.

**8.5 Final Thickness Measurement**—After the rest period, measure the final thickness at the center of the specimen in accordance with 8.1.

**9. Calculation**

9.1 Calculate the compression set as a percentage of the original thickness as follows:

$$C_A = [(t_o - t_i)/t_o] \times 100 \quad (1)$$

where:

$C_A$  = compression set (Method A) as a percentage of the original thickness,  
 $t_o$  = original thickness (8.1), and  
 $t_i$  = final thickness (8.5).

**10. Report**

10.1 The report shall include the following:

- 10.1.1 Original dimensions of the test specimen, including the original thickness,  $t_o$ ,
- 10.1.2 Actual compressive force on the specimen as determined from the calibration curve of the spring and spring deflection reading (7.2.1) or as applied by an external force (7.2.2),
- 10.1.3 Thickness of the test specimen 30 min after removal from the clamp,  $t_i$ ,
- 10.1.4 Type of test specimen used, together with the time and temperature of test,
- 10.1.5 Compression set, expressed as a percentage of the original thickness,
- 10.1.6 Method used (Method A), and
- 10.1.7 Number of specimens tested.

**METHOD B—COMPRESSION SET UNDER CONSTANT DEFLECTION IN AIR****11. Apparatus**

11.1 *Dial Micrometer*—A dial micrometer, for measuring the specimen thickness, in accordance with Practice D 3767, Method A1.

NOTE 4—For vulcanizates having a hardness below 35 IRHD, the force on the presser foot should be reduced to  $0.2 \pm 0.05$  N ( $0.04 \pm 0.01$  lbf).

11.2 *Spacer Bars*, to maintain the constant deflection required under Method B.

11.2.1 Spacer bars for Type 1 samples shall have a thickness of  $9.5 \pm 0.02$  mm ( $0.375 \pm 0.001$  in.).

11.2.2 Spacer bars for Type 2 samples shall have a thickness of  $4.50 \pm 0.01$  mm ( $0.1770 \pm 0.0005$  in.).

11.3 *Compression Device*, consisting of two or more flat steel plates between the parallel faces of which the specimens may be compressed as shown in Fig. 3. Steel spacers for the required percentage of compression given in 12.2 shall be

placed on each side of the rubber specimens to control their thickness while compressed. The steel surfaces contacting the rubber specimens shall be ground to a maximum roughness of 250  $\mu\text{m}$  (10  $\mu\text{in.}$ ) and then chromium plated and polished.

11.4 *Oven*, conforming to the specification for a Type IIB laboratory oven given in Specification E 145.

11.5 *Plates*—The plates between which the test specimen is compressed shall be made of steel of sufficient thickness to withstand the compressive stresses without bending. The surfaces against which the specimen is held shall have a highly polished chromium-plated finish and shall be cleaned thoroughly and wiped dry before each test.

## 12. Procedure

12.1 *Original Thickness Measurement*—Measure the original thickness of the specimen to the nearest 0.02 mm (0.001 in.). Place the specimen on the anvil of the dial micrometer so that the presser foot will indicate the thickness at the central portion of the top and bottom faces.

12.2 *Application of Compressive Force*—Place the test specimen between the plates of the compression device with the spacers on each side, allowing sufficient clearance for the bulging of the rubber when compressed (Fig. 3). Where a lubricant is applied, it shall consist of a thin coating of a lubricant having substantially no action on the rubber. For most purposes, a silicon or fluorosilicon fluid is suitable. Tighten the bolts so that the plates are drawn together uniformly until they are in contact with the spacers. The amount of compression employed shall be approximately 25 %. A suitable mechanical or hydraulic device may be used to facilitate assembling and disassembling the test fixture.

12.3 *Test Time and Temperature*—Choose a suitable temperature and time for the compression set, depending upon the conditions of the expected service. In comparative tests, use identical temperature and test periods. It is suggested that the test temperature be chosen from those listed in Recommended Practice D 1349. Suggested test periods are 22 h and 70 h. The test specimen shall be at room temperature when inserted in the compression device. Place the assembled compression device in the oven within

2 h after completion of the assembly and allow it to remain there for the required test period in dry air at the test temperature selected. At the end of the test period, take the device from the oven and remove the test specimen immediately and allow them to cool.

12.4 *Cooling Period*—While cooling, allow the test specimen to rest on a poor thermally conducting surface, such as wood, for 30 min before making the measurement of the final thickness. Maintain the conditions during the cooling period in accordance with 8.4.

12.5 *Final Thickness Measurement*—After the rest period, measure the final thickness at the center of the test specimen in accordance with 12.1.

## 13. Calculation

13.1 Calculate the compression set expressed as a percentage of the original deflection as follows:

$$C_B = [(t_o - t_f)/(t_o - t_n)] \times 100 \quad (2)$$

where:

$C_B$  = compression set (Method B) expressed as percentage of the original deflection,  
 $t_o$  = original thickness of specimen (12.1),  
 $t_f$  = final thickness of specimen (12.5), and  
 $t_n$  = thickness of the spacer bar used.

NOTE 5—Lubrication of the operating surfaces of the compression device is optional while giving more reproducible results, lubrication may somewhat alter the compression set values.

## 14. Report

14.1 The report shall include the following:

14.1.1 Original dimensions of the test specimen including the original thickness,  $t_o$ ,

14.1.2 Percentage compression of the specimen actually employed,

14.1.3 Thickness of the test specimen 30 min after removal from the clamp,  $t_f$ ,

14.1.4 Type of test specimen used, together with the time and temperature of test,

14.1.5 Whether or not the surfaces of the compression device are lubricated. If they are, what type lubrication was used,

14.1.6 Compression set, expressed as a percentage of the original deflection,

14.1.7 Method used (Method B), and

14.1.8 Number of specimens tested.

### 15. Precision<sup>a</sup> and B.

15.1 These precision statements have been prepared in accordance with Practice D 3040-81. Please refer to this practice for terminology and other testing and statistical concepts.

15.2 Prepared test specimens of two rubbers, Methods A and B, were supplied to five laboratories. These were tested in duplicate each day on two separate testing days. A test result, therefore, is the average of two test specimens, for both Methods A and B.

15.3 One laboratory did not run the Method

A testing, therefore the precision for Method A is derived from four laboratories.

15.4 The precision results are given in Tables 1 and 2.

15.5 *Bias*—In test method statistical terminology, bias is the difference between an average test value and the reference or true test property value. Reference values do not exist for this test method since the value or level of the test property is exclusively defined by the test method. Bias, therefore, cannot be determined.

<sup>a</sup> Supporting data are available from ASTM Headquarters. Request RR: D-11-1138.

TABLE 1 LQC Precision Data Compression Set—Method A

Material	Mean Level	Within Laboratories		Among Laboratories	
		<i>S</i>	<i>CV</i>	<i>S</i>	<i>CV</i>
A	1.73 (%)	0.0500	0.0277	0.190	0.1096
B	26.1	0.898	0.0336	2.37	0.0908
Average or Pooled Values		0.636	0.0308	1.681	0.1006
		Repeatability		Reproducibility	
Standard Deviation, ( <i>S</i> ) <sup>a</sup>		0.636		1.743	
Coefficient of Variation, ( <i>CV</i> )		0.0308		0.103	
Least Significant Difference, ( <i>LSD</i> ) <sup>b,c</sup>		8.8 %		29.1 %	

<sup>a</sup> An average value, the value of *S* varies with mean level.

<sup>b</sup> *LSD* based on 95 % confidence level; two results are considered significantly different if their difference, expressed as a percentage of their average, exceeds the stated percent value.

<sup>c</sup> The *LSD* values are relative percent, that is, a percent of the "percent" values used to measure the tested property.

TABLE 2 LQC Precision Data Compression Set—Method B

Material	Mean Level	Within Laboratories		Among Laboratories	
		<i>S</i>	<i>CV</i>	<i>S</i>	<i>CV</i>
A	13.7 (%)	0.591	0.0420	1.543	0.113
B	52.8	0.567	0.0110	5.924	0.112
Average or Pooled Values		0.579	0.0307	4.329	0.1124
		Repeatability		Reproducibility	
Standard Deviation, ( <i>S</i> ) <sup>a</sup>		0.579		4.348	
Coefficient of Variation, ( <i>CV</i> )		0.0307		0.114	
Least Significant Difference, ( <i>LSD</i> ) <sup>b,c</sup>		8.7 %		32.4 %	

<sup>a</sup> An average value, the value of *S* varies with mean level.

<sup>b</sup> *LSD* based on 95 % confidence level; two results are considered significantly different if their difference, expressed as a percentage of their average, exceeds the stated percent value.

<sup>c</sup> The *LSD* values are relative percent, that is, a percent of the "percent" values used to measure the tested property.

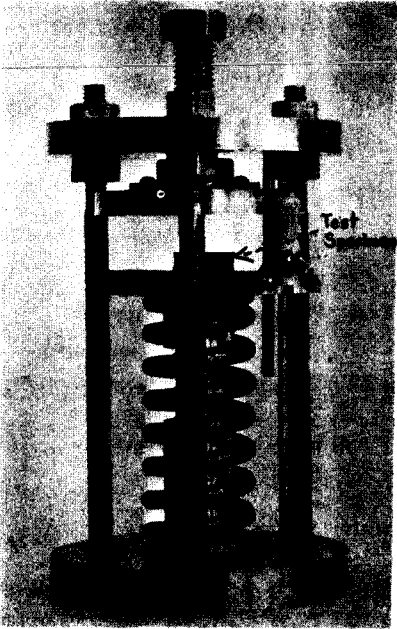

FIG. 1 Device for Compression Set Test, Using Calibrated Spring Loading, Method A

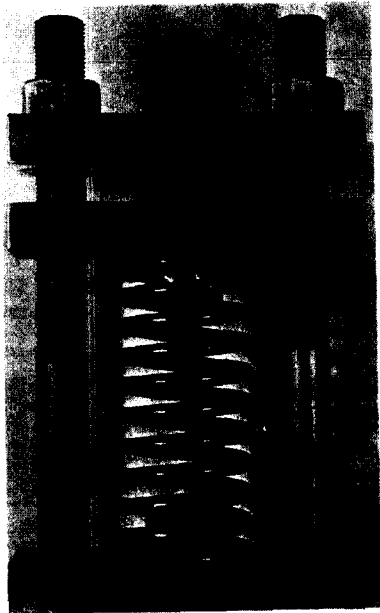

FIG. 2 Device for Compression Set Test, Using External Loading, Method A

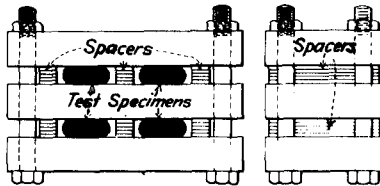

FIG. 3 Device for Compression Set Test Under Constant Deflection, Method B

*The American Society for Testing and Materials takes no position respecting the validity of any patent rights asserted in connection with any item mentioned in this standard. Users of this standard are expressly advised that determination of the validity of any such patent rights, and the risk of infringement of such rights, are entirely their own responsibility.*

*This standard is subject to revision at any time by the responsible technical committee and must be reviewed every five years and if not revised, either reapproved or withdrawn. Your comments are invited either for revision of this standard or for additional standards and should be addressed to ASTM Headquarters. Your comments will receive careful consideration at a meeting of the responsible technical committee, which you may attend. If you feel that your comments have not received a fair hearing you should make your views known to the ASTM Committee on Standards, 1916 Race St., Philadelphia, Pa. 19103.*

VII-B



National Aeronautics and  
Space Administration  
Washington, D.C.  
20546

JUL 17 1985

10 AM of MPS

**TO:** M/Associate Administrator for Space Flight  
**FROM:** MPS/Irv Davids  
**SUBJECT:** Case to Case and Nozzle to Case "O" Ring Seal Erosion Problems

As a result of the problems being incurred during flight on both case to case and nozzle to case "O" ring erosion, Mr. Hamby and I visited MSFC on July 11, 1985, to discuss this issue with both project and S&E personnel. Following are some important factors concerning these problems:

**A. Nozzle to Case "O" ring erosion**

There have been twelve (12) instances during flight where there have been some primary "O" ring erosion. In one specific case there was also erosion of the secondary "O" ring seal. There were two (2) primary "O" ring seals that were heat affected (no erosion) and two (2) cases in which soot blew by the primary seals.

The prime suspect as the cause for the erosion on the primary "O" ring seals is the type of putty used. It is Thiokol's position that during assembly, leak check, or ignition, a hole can be formed through the putty which initiates "O" ring erosion due to a jetting effect. It is important to note that after STS-10, the manufacturer of the putty went out of business and a new putty manufacturer was contracted. The new putty is believed to be more susceptible to environmental effects such as moisture which makes the putty more tacky.

There are various options being considered such as removal of putty, varying the putty configuration to prevent the jetting effect, use of a putty made by a Canadian Manufacturer which includes asbestos, and various combination of putty and grease. Thermal analysis and/or tests are underway to assess these options.

Thiokol is seriously considering the deletion of putty on the QM-5 nozzle/case joint since they believe the putty is the prime cause of the erosion. A decision on this change is planned to be made this week. I have reservations about doing it, considering the significance of the QM-5 firing in qualifying the FWC for flight.

PC 098840



It is important to note that the cause and effect of the putty varies. There are some MSFC personnel who are not convinced that the holes in the putty are the source of the problem but feel that it may be a reverse effect in that the hot gases may be leaking through the seal and causing the hole track in the putty.

Considering the fact that there doesn't appear to be a validated resolution as to the effect of putty, I would certainly question the wisdom in removing it on QM-5.

#### B. Case to Case "O" Ring Erosion

There have been five (5) occurrences during flight where there was primary field joint "O" ring erosion. There was one case where the secondary "O" ring was heat affected with no erosion. The erosion with the field joint primary "O" rings is considered by some to be more critical than the nozzle joint due to the fact that during the pressure build up on the primary "O" ring the unpressurized field joint secondary seal unseats due to joint rotation.

The problem with the unseating of the secondary "O" ring during joint rotation has been known for quite some time. In order to eliminate this problem on the FWC field joints a capture feature was designed which prevents the secondary seal from lifting off. During our discussions on this issue with MSFC, an action was assigned for them to identify the timing associated with the unseating of the secondary "O" ring and the seating of the primary "O" ring during rotation. How long it takes the secondary "O" ring to lift off during rotation and when in the pressure cycle it lifts are key factors in the determination of its criticality.

The present consensus is that if the primary "O" ring seats during ignition, and subsequently fails, the unseated secondary "O" ring will not serve its intended purpose as a redundant seal. However, redundancy does exist during the ignition cycle, which is the most critical time.

It is recommended that we arrange for MSFC to provide an overall briefing to you on the SRM "O" rings, including failure history, current status, and options for correcting the problems.

*Irving Davids*  
Irving Davids

cc:  
M/Mr. Weeks  
M/Mr. Hamby  
ML/Mr. Harrington  
MP/Mr. Winterhalter

## VII-C

National Aeronautics and  
Space Administration  
George C. Marshall Space Flight Center  
Marshall Space Flight Center, Alabama  
35812

**NAS**  
August 1981

File to ATRN of: SA42-349-85

TO: NASA Headquarters  
Attn: Code M/W. S. Hamby

FROM: SA41/L. B. Mulloy

SUBJECT: SRN Joint/O-Ring Erosion

On July 11, 1985 you and Irv Davids were briefed by Jim Thomas of my office on the history and the effort underway to resolve the issues and concerns of the above subject. During this briefing the following information was requested:

1. **Question:** If the field joint secondary seal lifts off the metal mating surfaces during motor pressurization, how soon will it return to a position where contact is re-established?

**Answer:** Bench test data indicates that the o-ring resiliency (its capability to follow the metal) is a function of temperature and rate of case expansion. NTI measured the force of the o-ring against Instron platens, which simulated the nominal squeeze on the o-ring and approximated the case expansion distance and rate.

At 100°F the o-ring maintained contact. At 75°F the o-ring lost contact for 2.4 seconds. At 50°F the o-ring did not re-establish contact in ten minutes at which time the test was terminated.

The conclusion is that secondary sealing capability in the SRN field joint cannot be guaranteed.

2. **Question:** If the primary o-ring does not seal, will the secondary seal seat in sufficient time to prevent joint leakage?

**Answer:** NTI has no reason to suspect that the primary seal would ever fail after pressure equilibrium is reached, i.e., after the ignition transient. If the

primary o-ring were to fail from 0 to 170 milliseconds, there is a very high probability that the secondary o-ring would hold pressure since the case has not expanded appreciably at this point. If the primary seal were to fail from 170 to 330 milliseconds, the probability of the secondary seal holding is reduced. From 330 to 600 milliseconds the chance of the secondary seal holding is small. This is a direct result of the o-ring's slow response compared to the metal-case segments as the joint rotates.

3. **Question:** Headquarters was not aware that the secondary o-ring may not seat due to joint rotation, when was this incorporated into the FMEA/CIL?

**Answer:** HTI submitted TWR-13520 "Retention Rationale, SRM Simplex Seal" to MSFC on 12/1/82. The SRM CIL requirement change was approved by Level III CCB on 1/21/83. Level II authorized submittal of Level I change request H22106L on 3/2/83. On 5/2/83 Level II issued PRCD S22106LR1 to implement approved Level I change request H22106L and H22106M.

L. B. Mulloy  
Manager, SBS Project

cc:  
SA41/Messrs. West/Thomas

## VIII-A

MAR 12 '86 12:11 NASA HQ WASH. D.C.

PAGE 04

**NASA**Space  
Flight

S/O.P.D. 710.5A

DATE 9/26/82

**IN EFFECT FOR  
STS 51-L****PROGRAM DIRECTIVE**

Responsible Office: SF/Space Shuttle Operations, Integration Division

SUBJECT: Space Shuttle Flight Readiness Review

**1. PURPOSE**

This Directive defines the responsibilities, requirements, and procedures to insure effective planning for and conduct of Flight Readiness Reviews for the Space Transportation System (STS) missions.

**2. SCOPE**

This Directive is applicable to all STS missions.

**3. POLICY**

It is the policy of the Associate Administrator for Space Flight (AA-SF) to make an assessment of mission readiness prior to each flight. This will be accomplished by a consolidated Flight Readiness Review (FRR) of all activities/elements necessary for safe and successful conduct of the launch, flight, and post-landing operations. The review will be supported by the NASA Chief Engineer and the Center Directors from JSC, MSC, and KSC.

The FRR will be preceded by detailed readiness reviews (pre-FRR's) on individual elements, including cargo, under the cognizance of the responsible Managers.

**4. RESPONSIBILITIES**

- a. The conduct of the FRR is the responsibility of the AA-SF or his designated representative.
- b. The Director, Space Shuttle Operations, is responsible for FRR planning and requirements, coordinating the FRR agenda, FRR action items and action item closeouts, and preparing the readiness assessment.
- c. The JSC Level II National Space Transportation System (NSTS) Program Manager is responsible for implementing readiness review plans and requirements, organizing the FRR, and for the program assessment of flight readiness.
- d. The project/element Managers will conduct pre-FRR's to develop their readiness assessment and are responsible for the FRR briefing content.

Att 1-1

in their particular area.

#### 5. REVIEW REQUIREMENTS

- a. Review Concept: The FFR will employ a delta review concept from prior Reviews (eg. Acceptance, Orbiter Rollout/Pre-Stack, Cargo Readiness) and previous STS missions. The review will be conducted by telecon using the NASA Teleconference Network.
- b. Schedule: The FFR will be held between one and two weeks prior to launch.
- c. Agenda: The major agenda items and responsibilities are:
- (1) Introduction ----- Headquarters/AA-EF
  - (2) Integrated System ----- JSC/Manager, N22S Program
  - (3) Orbiter/Crew CPE ----- JSC/Manager, Space Shuttle Projects
  - (4) SDPE/EC/ESR ----- NSPC/Manager, Space Shuttle Projects
  - (5) Cargo ----- JSC/Manager, Mission Integration
  - (6) Launch & Landing ----- ESC/Director, Shuttle Projects Operations Management
  - (7) Flight Operations ----- JSC/Director, Mission Operations
  - (8) Safety, Reliability & ----- JSC/ER & QA Manager, Space Shuttle Quality Assurance
  - (9) Action Items/Readiness ----- Headquarters/AA-EF Poll
- d. Presentation Emphasis: The presentation of agenda items will normally include a brief status summary with appropriate supporting detail on significant items and conclude with a readiness assessment. The presentation topics and scope should be developed from the pre-FFR's and should:
- (1) be that required to provide the AA-EF with the information needed to make a judgment as to flight readiness;
  - (2) review recent significant resolved problems and prior flight anomalies when necessary to establish confidence;
  - (3) cover all problems, open items, and constraints remaining to be resolved before the mission;
  - (4) establish the mission baseline configuration in terms of all significant changes since the last STS mission (changes to be considered include hardware, software, vehicle servicing/cleanup, launch event criteria, flight plans.

flight rules, and crew procedures);

Within the above guidelines, the scope of the review should cover status and issues in areas such as: vehicle checkout, shortages and open work, unexplained anomalies, hardware failures, prior flight anomalies, certification/verification, as-built hardware configuration versus certified hardware list, Critical Item List (CIL), development, qualification, and reliability testing, waivers and deviations, limited life components, launch critical spares, sneak circuits, system safety/hazards, and flight margins. In addition, the review should also cover readiness of ground systems/facilities (e.g., launch site, landing sites, network, Mission Control Center), operations teams (e.g., launch, recovery, flight crew, flight control), and support operations (e.g., EOD, contingency, weather, medical, security).

6. DOCUMENTATION REQUIREMENTS

- a. Presentations: Vynographs will be used for FPR presentations, and a paper copy will be provided to the reviewing officials. A copy of the presentation material shall be provided to telecon locations 24 hours in advance of the review.
- b. Certificate of Flight Readiness (CoFR): CoFR endorsements, including a complete listing of exceptions, will be executed and submitted at the conclusion of the review (Reference: Space Shuttle Program Procedure for Certification of Flight Readiness (CoFR), JSC 08117, current revision).
- c. FPR Assessment: A FPR assessment letter will be issued by OGP within two working days after the review and will include the following:
  - (1) Action items;
  - (2) Significant decisions;
  - (3) CoFR exceptions and endorsement summary.

7. FPR ACTION ITEM/OPEN ITEM CLOSEOUT REPORTING REQUIREMENTS

- a. Status: The NTE Program Manager will report periodically on the closeout status of action items/open items identified at the FPR. This may be accomplished by the Daily Special Level II PRCD.

Significant items occurring subsequent to the FPR will also be reported to the AA-GF. Actions that can be easily accomplished without safety, mission, or launch impact and do not violate flight vehicle or launch complex configuration integrity or cause basic changes to launch commit criteria, flight rules, flight plan, or abort and alternate mission plans, need not be reported.

- b. Action Item Closeouts: Closeouts to FPR action items will be submitted to the AA-GF by Level III/II in writing or fax and will state fully the basis for closeout, that is: action taken, results

PC 08117

obtained, and determinations made. An action will not be closed until signoff is completed by the AA-SF or his designated representative.

- c. CRF Exceptions: The resolution of all exceptions identified in the CRF endorsement will be completed by two days prior to launch, and a copy of the endorsement will be submitted to the Director, Space Shuttle Operations.

#### 8. PROCEDURES

- a. Single Points of Contact: FFR planning and procedures will be coordinated through single points of contact established at the following locations:

Headquarters - Space Shuttle Operations, Integration Division  
 JSC - Level II NSTS Program Office  
 NSPC - Space Shuttle Projects Office  
 KSC - Space Shuttle Projects Management Directorate

Individuals will be designated by the responsible organizations and the names provided to the Director, Space Shuttle Operations. Duties will be defined by separate correspondence issued by the Director, Space Shuttle Operations.

- b. Guidelines: Approximately three weeks prior to the FFR, guidelines will be issued by the Director, Space Shuttle Operations, establishing the review date and any special requirements not covered by this directive.
- c. FFR Agenda: Proposed agenda items/times will be submitted to Level I/II by the single points of contact at the respective Centers two weeks prior to the FFR. Responsible Space Shuttle Operations Directors will coordinate detailed presentation items with their Project and will accept items determined to be completed and not requiring the AA-SF review at the FFR. The final FFR agenda will be coordinated by the Director, Space Shuttle Operations, and issued about one week prior to the FFR.

#### 9. ACTION

This Directive supersedes STS-PD 710.5 dated May 13, 1981, and shall be implemented by the JSC/NSTB Program Manager effective STS-9 and subsequent missions.

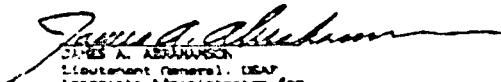
  
 JAMES A. ASHWORTH  
 Lieutenant General, USAF  
 Associate Administrator for  
 Space Flight

2000000000

VIII-B

TWR-15380

STS-51L (STS-33) SOLID ROCKET MOTOR (SRM-25)  
FLIGHT READINESS REVIEW

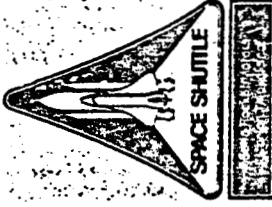

11 DECEMBER 1985

MORTON THITOKOL, INC.

---

WASATCH DIVISION  
P.O. BOX 524, BRIGHAM CITY, UTAH 84302 (801) 863-3511



## AGENDA

SECTION	
1.0	0 STS-61C (STS-32) (SRM-24) PERFORMANCE
2.0	0 PROBLEM SUMMARY
3.0	0 STS-51L (STS-33) (SRM-25) CHANGES
	0 CHANGE SUMMARY
	0 DESIGN
	0 HARDWARE CHANGEOUT
	0 PROCESS CHANGES
	0 FIRST TIME CONFIGURATION REUSED
	0 OMRSD
	0 OMD
4.0	0 CERTIFICATION/VERIFICATION STATUS
5.0	0 STS-51L (STS-33) (SRM-25) PERFORMANCE PREDICTIONS
6.0	0 TECHNICAL ISSUES
7.0	0 FLIGHT READINESS REVIEW

90 031079

STS-61C (STS ) (SRM-24)  
PERFORMANCE  
(CHART NO. 1-1)

TO BE DISCUSSED

RESOLUTION

CONCERN

PROBLEM

TBD

PC 053072

# Organizational Issuance



George C. Marshall Space Flight Center  
Marshall Space Flight Center, Alabama 35812

Effective Date: December 29, 1983	Number: SOP 8000.1
Organization: Shuttle Projects Office	

Subject: SHUTTLE PROJECT FLIGHT READINESS REVIEW

## 1. PURPOSE

This procedure defines the responsibilities, requirements, and procedures to insure effective planning for and conduct of the Shuttle Projects Flight Readiness Review.

## 2. SCOPE

This procedure is applicable to all STS missions.

## 3. POLICY

- a. It is the policy of the Manager, Shuttle Projects to make an assessment of flight readiness of the Shuttle projects prior to each flight. This will be accomplished by a consolidated Flight Readiness Review (FRR) of all MSFC Shuttle Projects Office elements necessary for safe and successful conduct of the launch, flight, and post-landing operations. The review will be supported by all MSFC organizations which participate in MSFC Shuttle Projects activities.
- b. The Shuttle Project FRR will be preceded by separate detailed readiness reviews (pre-FRR's) of individual elements by the prime contractor's and the element project offices, under the cognizance of the responsible Managers.

## 4. RESPONSIBILITIES

- a. The conduct of the Shuttle Projects FRR is the responsibility of the Manager, Shuttle Projects or his designated representative.
- b. The Program Plans and Management Systems Office is responsible for FRR scheduling, planning and requirements, coordinating the FRR agenda, FRR action items and action item closeouts, and preparing the readiness assessment and maintenance of all records associated therewith. The Program Plans and Management Systems Office will be the focal point with the JSC Level II National Space Transportation System (NSTS) Program Manager and the Level I FRR under the cognizance of the Director, Space Shuttle Operations.

PC 05634

73

SOP 8000.1

- c. The Project Managers will assure the effectivity of a detailed prime contractor pre-FRR.
- d. The Project Managers will conduct FRR's to develop their readiness assessment and are responsible for the Shuttle Projects FRR briefing content in their particular area.

### 5. PRIME CONTRACTOR PRE-FRR

Project Managers will assure that each prime contractor conducts a pre-FRR in preparation for the Project Offices FRR. The contractors review shall be chaired by a level of management at least one level above the contractor Project Manager.

### 6. SHUTTLE ELEMENT FRR

- a. The Project will conduct a FRR in preparation for the Shuttle Projects FRR. The respective Project Manager of element under review will serve as Chairman. The membership will consist of representatives from the following:

Shuttle Projects Office

S&E Directorate

Reliability and Quality Assurance

Safety

Contractors

USBI, MMC, Thiokol, Rocketdyne

- b. Each Project Office will make the necessary conference arrangements, notify review members, designate secretary, prepare presentations, record and track action items, closures and retain a copy of the presentation material in the Project Office record file.

### 7. SHUTTLE PROJECTS FRR REQUIREMENTS

- a. Review Concept: The Shuttle Projects FRR will employ a delta review concept from prior reviews and previous STS missions.
- b. Schedule: The Shuttle Projects FRR will be held prior to the Center FRR.
- c. Agenda: The major agenda items and responsibilities are:
 

(1) Introduction	Programs Plans and Management Systems Office
(2) Systems	Manager, Systems Management Office
(3) External Tank	Manager, External Tank Project Office

PC 050325

74

- |     |                                |                                                 |
|-----|--------------------------------|-------------------------------------------------|
| (4) | Solid Rocket Booster           | Manager, Solid Rocket Booster<br>Project Office |
| (5) | Flight Engine                  | Manager, Flight Engine Project<br>Office        |
| (6) | Action Items/Readiness<br>Poll | Program Plans and Management<br>Systems Office  |

d. **Presentation Emphasis:** The presentation of agenda items will normally include a brief status summary with appropriate supporting detail on significant items and conclude with a readiness assessment. The presentation topics and scope should be developed from the Project FRR's and should:

- (1) be that required to provide the Shuttle Projects Manager and Review Team with the information needed to make an independent judgement as to flight readiness;
- (2) review recent significant resolved problems and prior flight anomalies when necessary to establish confidence;
- (3) cover all problems, technical issues, open items, and constraints remaining to be resolved before the flight;
- (4) establish the flight baseline configuration in terms of all significant changes since the last flight and/or applicable STS flight.

Within the above guidelines, the scope of the review should cover status, changes and issues in areas such as:

- (1) Hardware/Software Anomalies, Failures including development and acceptance test failures
- (2) Launch Commit Criteria
- (3) Flight Plans/Rules
- (4) Vehicle Checkout
- (5) Shortages and Open Work
- (6) Prior Flight Anomalies
- (7) As-built Hardware Configuration versus Certified Hardware List
- (8) Critical Item List (CIL)/Hazards
- (9) Development, Qualification, and Reliability Testing (Certification/Verification)
- (10) Waivers and Deviations
- (11) Limited Life Components
- (12) Launch Critical Spares
- (13) Sneak Circuits
- (14) Flight Margins
- (15) PAS Assessment
- (16) Safety
- (17) Process Changes: Design, manufacturing, checkout and launch processing

PC 056036

75

SOP 8000.1

- a. Shuttle Projects FRR Membership: The Manager, Shuttle Projects will establish review membership and serve as Chairman. Membership will comprise representation from the following organizations:

Program/Project Offices

Science & Engineering Directorate

Reliability & Quality Assurance

Safety

Contractors

USBI, MMC, Thiokol, Rocketdyne

f. Documentation Requirements

- (1) Presentations: Yugraphs will be used for FRR presentations and paper copies will be provided to the reviewing officials.
- (2) Statement of Flight Readiness: Statement of Flight Readiness will be executed by all Project Managers and submitted at the conclusion of the review.

g. FRR Action Item/Open Item Closeout Reporting Requirements

- (1) Subsequent to the conclusion of the Shuttle Projects FRR, a copy of assigned action items will be provided to each actionee by the Program Plans and Management Systems Office.
- (2) The FRR secretary will track all action items and provide status to the Shuttle Projects Manager.
- (3) Closeouts to FRR action items will be submitted to the Program Plans and Management Systems Office in writing and will state fully the basis for closeout, that is: action taken, results obtained, and determinations made. The Program Plans and Management Systems Office will submit closures to the Manager, Shuttle Projects or his designated representative for signature.

h. Procedures

- (1) Single Points of Contact: FRR planning and procedures will be coordinated through a single point of contact in the Program Plans and Management Systems Office.

Individual element for points of contact will be designated by the responsible Project Manager and the names provided to the Program Plans and Management Systems Office. These individuals will be responsible for these duties outlined in paragraph 6.b.

PC 056887

- (2) Guidelines: Approximately three weeks prior to the MSFC Shuttle Projects FRR, guidelines will be prepared by Program Plans and Management Systems Office and issued by the Manager, Shuttle Projects, establishing Projects FRR date, Shuttle Projects FRR date, with applicable membership, and any special requirements not covered by this procedure.

8. EFFECTIVE DATE

This procedure is effective on date of issue.



Robert E. Lindstrom  
Manager, Shuttle Projects

SOP 8000.1

cc:

SA01/Dr. Lovingood  
SA01/Mr. Askew  
SA04/Mr. Harden  
SA11/Mr. Lombardo  
SA31/Mr. Bridwell  
SA41/Mr. Mulloy  
SA51/Mr. Taylor  
SA71/Mr. Boze  
SA81/Mr. Zoller  
EA01/Mr. Kingsbury  
EA01/Dr. Thomson  
EE01/Mr. Hardy  
EE11/Mr. Horton  
EE21/Mr. Thomason  
EE31/Mr. Nichols  
EE51/Mr. Goetz  
EG01/Mr. Brooks  
EG03/Mr. Bunn  
EB01/Mr. Bradford  
EH01/Mr. Schwingamer  
ES01/Dr. Dessler  
EP01/Mr. McCool  
EP43/Mr. Worlund  
EL01/Mr. Hopson  
ED01/Dr. McDonough  
ET01/Mr. Taylor  
PD01/Mr. Marshall  
TA01/Mr. Odom  
NA01/Mr. Thomas  
JA01/Mr. Downey  
DA01/Dr. Lucas  
DD01/Mr. Lee  
DE01/Mr. Bethay  
DR01/Mr. Sneed

PC 056009



## VIII-D

National Aeronautics and  
Space Administration



George C. Marshall Space Flight Center  
Marshall Space Flight Center, Alabama  
35812

Reply to Airmail

DA01

JAN 7 1986

TO: Distribution  
FROM: DA01/W. R. Lucas  
SUBJECT: MSFC Flight Readiness Review (FRR) Board  
for MSFC Elements for Mission 51-L

An MSFC FRR Board of senior MSFC management personnel will convene at 8:30 a.m. on January 13, 1986, in Building 4663, HOSC/HCR, to review and assess the readiness status of the MSFC Mission 51-L elements for flight.

This meeting will be held at the SECRET level and all documentation will be handled and presented in accordance with the NASA Security regulations. Attendance will be restricted and all Projects are to coordinate this activity through the Program Planning and Management Systems Office, Tom Staples, 3-0338.

The Center Board is composed of the following:

DA01/W. R. Lucas:	Chairman
DD01/T. J. Lee	Vice Chairman
EA01/J. E. Kingsbury	
DS01/F. A. Speer	
EG01/J. P. Madole	
JA01/J. A. Downey	
PA01/W. R. Marshall	
CS01/J. C. Walker	
CA76/S. G. Henderson:	Secretariat

Each project manager must certify the flight readiness of his hardware and present supporting rationale and data so the Board can independently assess the flight readiness. The Shuttle Projects Office manager is responsible for preparation and coordination of the meeting, presenting an overall assessment of flight readiness, recording of minutes and action items, and tracking action items for closure by the Review Board.

*ATTACHMENT 2-9*

PC 014983

Emphasis will be placed on safety of flight and mission success, including potential impact of prior flight anomalies; ground test anomalies; revisions to hardware, software, launch commit criteria, or redlines which have not been flight verified; revisions to SRM recovery risks since the previous flight; any waiver which has not been flight verified or which requires external approval; and any revisions to hazard or critical item lists. Issues, concerns, and risks should be clearly identified as well as methods of closure.

In an effort to minimize administrative control requirements associated with the dissemination of classified data, an effort is to be made to present classified information only through viewgraphs. If Projects elect to incorporate classified data within their handouts, it is the Project's responsibility to assure that the handouts are marked and handled in accordance with the NASA Security regulations. If any assistance is needed in this matter, please contact the MSFC Security Division at 3-4210.

A preliminary agenda is enclosed.

  
W. R. Lucas  
Director

Enclosure

Distribution:  
See Page 3

PC 014984

VIII-E

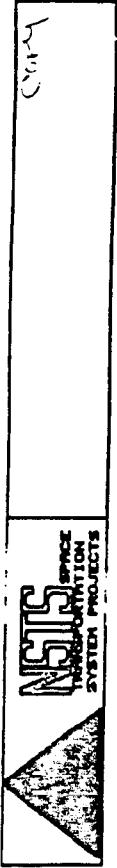

STS 51-L

LEVEL I

FLIGHT READINESS REVIEW

ARNOLD D. ALDRICH  
JANUARY 15, 1966

ATTACHMENT 2-B



STS 51-L FLIGHT READINESS REVIEW

SOLID ROCKET BOOSTER

L. B. MULLOY  
 MANAGER, SOLID ROCKET BOOSTER  
 JANUARY 15, 1986

**AGENDA**

- 0 STS 61-C FLIGHT ANOMALIES**
- 0 MAJOR ISSUES/PROBLEMS**
- 0 MAJOR CONFIGURATION DIFFERENCES**
- 0 CERTIFICATION/VERIFICATION STATUS**
- 0 READINESS STATEMENT**

**SND-2**

**ANOMALIES/PROBLEMS**

**0 NO 61-C FLIGHT ANOMALIES**

**0 NO MAJOR PROBLEMS OR ISSUES**

**SRD-3**

STS 51-L

SIGNIFICANT CONFIGURATION DIFFERENCE

CHANGE	REASON	BASIS FOR CERTIFICATION
IMPLEMENTS CAPABILITY TO SEPARATE SRJ NOZZLE AT APOGEE AND TO SEPARATE MAIN PARACHUTES AT WATER IMPACT	0 NOZZLE SEPARATION 0 PRECLUDE FRAGMENTS FROM NOZZLE EXTENSION DESTROYING DROGUE PARACHUTE	0 ANALYSIS - STRUCTURAL - DYNAMIC - FMEA
0 REDUCE DESIGN LOAD EXCEEDANCES ON MAIN PARACHUTE SYSTEM	0 REDUCE DESIGN LOAD EXCEEDANCES ON MAIN PARACHUTE SYSTEM	0 QUALIFICATION TEST
0 MAIN PARACHUTE SEPARATION 0 SRJ RETRIEVAL PERSONNEL SAFETY	0 MAIN PARACHUTE SEPARATION 0 SRJ RETRIEVAL PERSONNEL SAFETY	0 FORMAL PDR/CDR 0 DCR

SRJ-4



057E 202F 035M/220-70 01:11 96. 14 JAN 14  
PAGE 04 08 3500



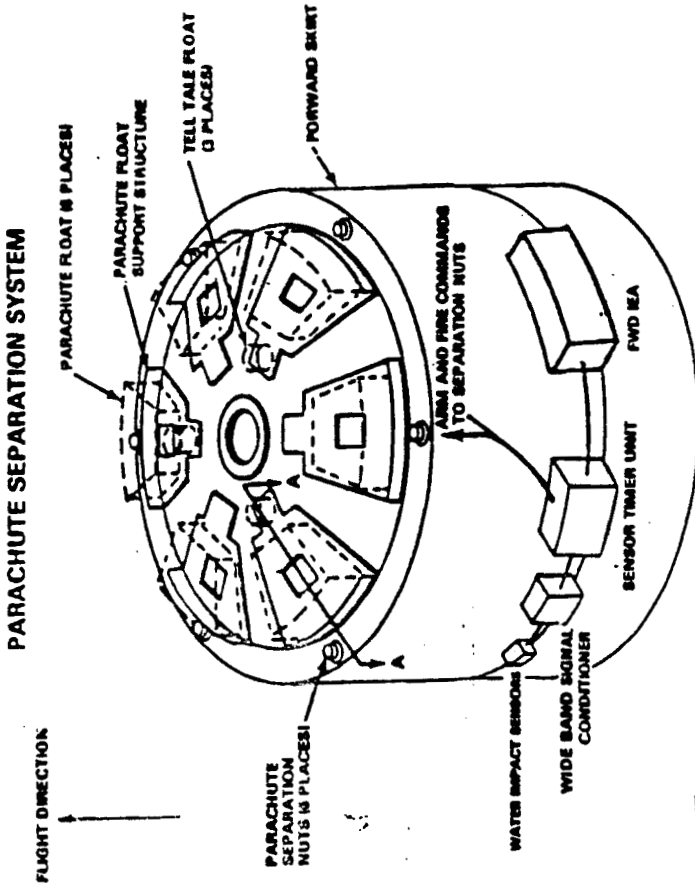

SRB-4

PAGE 05

JUN 14 08 11:16 9L-826/MSFC 4222 2458

# NOMINAL SRB REENTRY PROFILE (136 FOOT MAINS)

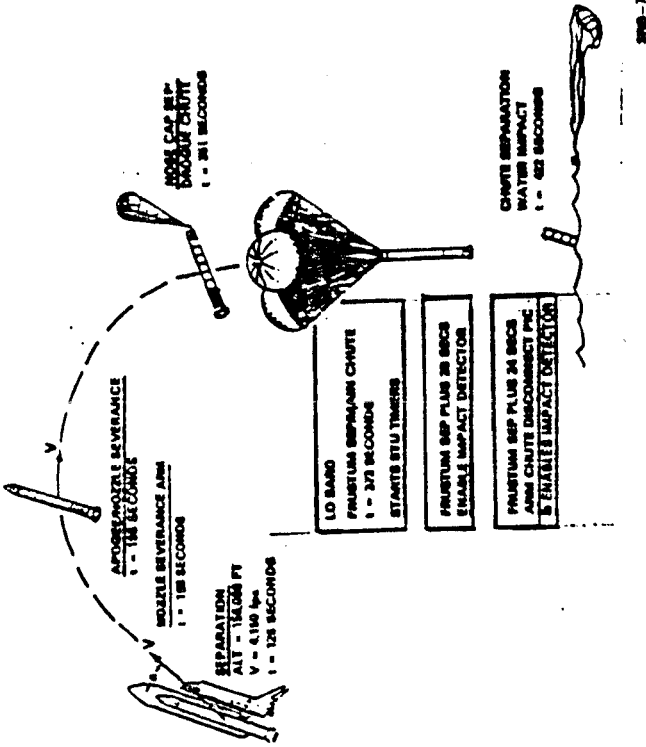

## SUMMARY OF DESIGN CERTIFICATION

- 0 DESIGN ASSURES SINGLE FAILURE WILL NOT CAUSE PREMATURE SEPARATION EVENTS:  
SEQUENCE PROTECTION
- SHUTTLE ENGINE/MOTOR IGNITION STU NOT POWERED UP
- STS BOOST PHASE STU NOT POWERED UP
- SRB SEPARATION STU NOT POWERED UP
- NOZZLE JETTISON STU POWERED - PARACHUTE PIC'S NOT ARMED WATER  
IMPACT SENSORS NOT ENABLED, PARACHUTE SEP TIMER  
NOT STARTED
- DROGUE DEPLOYMENT STU POWERED - PARACHUTE PIC'S NOT ARMED WATER  
IMPACT SENSORS NOT ENABLED, PARACHUTE SEP TIMER  
NOT STARTED
- FRUSTUM SEPARATION STU POWERED - PARACHUTE PIC'S NOT ARMED WATER  
IMPACT SENSORS NOT ENABLED, PARACHUTE SEP TIMER  
NOT STARTED
- 0 FMEA VERIFIES
  - 0 TWO CRITICAL FAILURES REQUIRED FOR MALFUNCTION
  - 0 ALL PYRO EVENTS OCCUR PRIOR TO ARMING PIC'S FOR PARACHUTE SEPARATION
  - 0 ALL OTHER FUNCTIONS OCCUR PRIOR TO ENABLING SEPARATION CIRCUITS
  - 0 BOTH WATER IMPACT SENSORS MUST INITIATE SEPARATION SIGNAL
  - 0 QUALIFICATION TESTS AND SYSTEMS CHECKOUT VERIFY PROPER SYSTEM OPERATION

SRB-8

D C 0 1 4 7 4 4

**CERTIFICATION/VERIFICATION STATUS**

**0 NO OPEN CERTIFICATION OF QUALIFICATION**

**0 NO OPEN HAZARDOUS/CTL'S**

**0 NO OPEN WAIVERS**

**0 NO OPEN UNPLANNED RSC WORK**

**END**

READINESS STATEMENT

PENDING SATISFACTORY COMPLETION OF NORMAL OPERATIONS FLOW (NORSO) AND OPEN ITEMS IDENTIFIED, WE CERTIFY THE SRB FLIGHT HARDWARE READY TO SUPPORT MISSION 51-L

/S/ MR. KILMINSTER

J. KILMINSTER, MIT  
VICE PRESIDENT  
SPACE BOOSTER PROGRAMS

/S/ MR. MURPHY

G. MURPHY, USBI-BPC  
EXECUTIVE VICE PRESIDENT

/S/ MR. SMITH

J. D. SMITH  
CHIEF ENGINEER, SRB PROJECT

/S/ MR. MULLOY

L. B. MULLOY  
MANAGER, SRB PROJECT

SRB-10

VIII-F

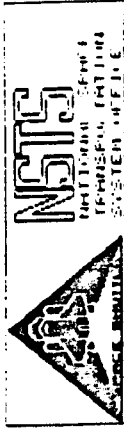

STS 51-L

LEVEL II

FLIGHT READINESS REVIEW

ARNOLD D. ALDRICH  
JANUARY 14, 1986

*ATTACHMENT 2-10*

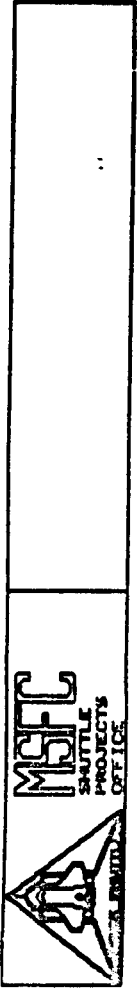

STS 51-L FLIGHT READINESS REVIEW

SOLID ROCKET BOOSTER

L. B. MULLOY  
 MANAGER, SOLID ROCKET BOOSTER  
 JANUARY 15, 1966

AGENDA

- 0 STS 61-C FLIGHT ANOMALIES
- 0 MAJOR ISSUES/PROBLEMS
- 0 MAJOR CONFIGURATION DIFFERENCES
- 0 CERTIFICATION/VERIFICATION STATUS
- 0 READINESS STATEMENT

SRB-2

PC 0100000



ANOMALIES/PROBLEMS

0 NO 61-C FLIGHT ANOMALIES

0 NO MAJOR PROBLEMS OR ISSUES

580-3

STS 51-L

SIGNIFICANT CONFIGURATION DIFFERENCE

CHANGE	REASON	BASIS FOR CERTIFICATION
IMPLEMENTS CAPABILITY TO SEPARATE SRM NOZZLE AT APOGEE AND TO SEPARATE MAIN PARACHUTES AT WATER IMPACT	0 NOZZLE SEPARATION 0 PRECLUDE FRAGMENTS FROM NOZZLE EXTENSION DESTROYING DROGUE PARACHUTE  0 REDUCE DESIGN LOAD EXCEEDANCES ON MAIN PARACHUTE SYSTEM  0 MAIN PARACHUTE SEPARATION	0 ANALYSIS - STRUCTURAL - DYNAMIC - FMEA  0 QUALIFICATION TEST  0 FORMAL PDR/CDR
	0 SRB RETRIEVAL PERSONNEL SAFETY	0 DCR

SRB-4

010004



PC 015325

575  
10/10/75

PC: 01 20 10 10 10

# PARACHUTE SEPARATION SYSTEM

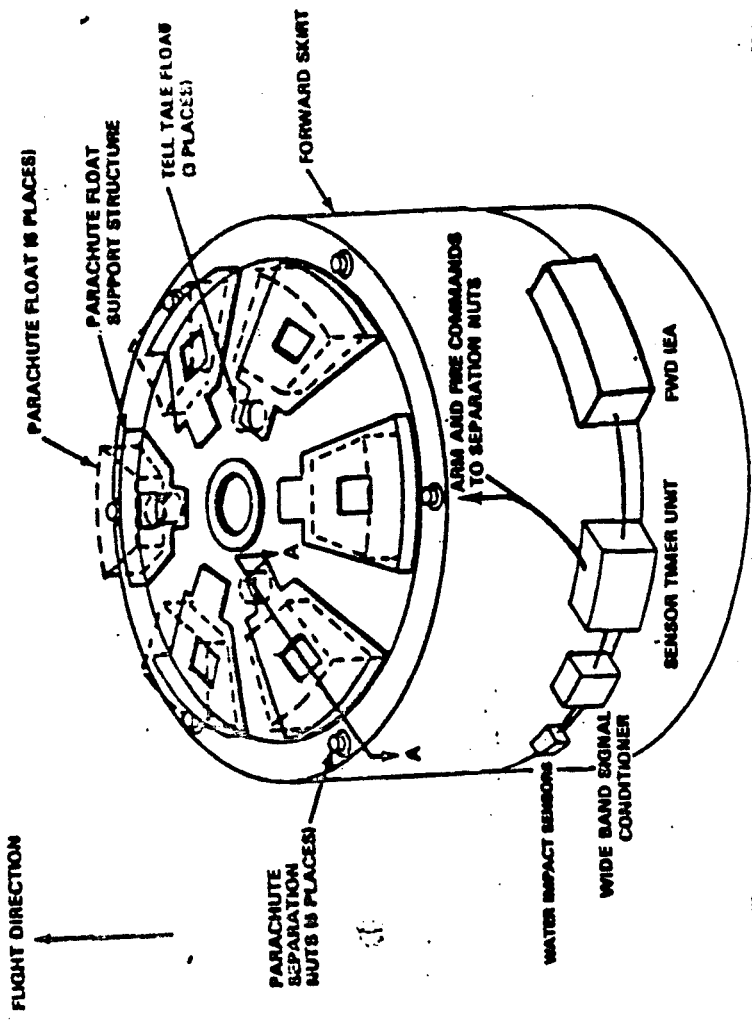

SRB-6

**NOMINAL SRB REENTRY PROFILE  
(136 FOOT MAINS)**

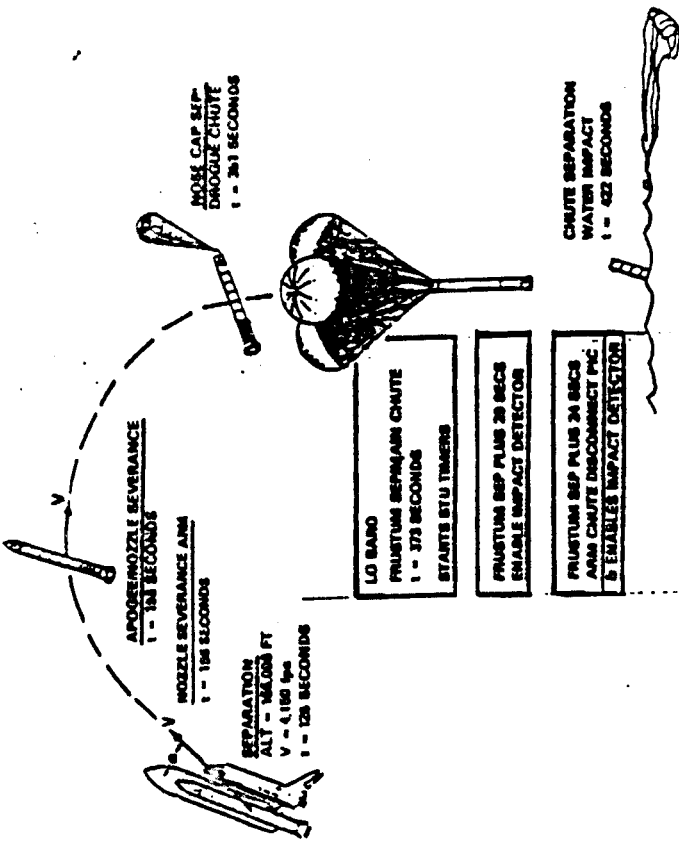

SRB-7

## SUMMARY OF DESIGN CERTIFICATION

- 0 DESIGN ASSURES SINGLE FAILURE WILL NOT CAUSE PREMATURE SEPARATION EVENTS:
  - SEQUENCE PROTECTION
  - SHUTTLE ENGINE/MOTOR IGNITION STU NOT POWERED UP
  - STS BOOST PHASE STU NOT POWERED UP
  - SRB SEPARATION STU NOT POWERED UP
  - NOZZLE JETTISON STU POWERED - PARACHUTE PIC'S NOT ARMED WATER IMPACT SENSORS NOT ENABLED, PARACHUTE SEP TIMER NOT STARTED
- 0 ROGUE DEPLOYMENT
  - STU POWERED - PARACHUTE PIC'S NOT ARMED, WATER IMPACT SENSORS NOT ENABLED, PARACHUTE SEP TIMER NOT STARTED
- 0 FRUSTUM SEPARATION
  - STU POWERED - PARACHUTE PIC'S NOT ARMED WATER IMPACT SENSORS NOT ENABLED, PARACHUTE SEP TIMER NOT STARTED
- 0 FMEA VERIFIES
  - 0 TWO OR MORE FAILURES REQUIRED FOR MALFUNCTION
  - 0 ALL PYRO EVENTS OCCUR PRIOR TO ARMING PIC'S FOR PARACHUTE SEPARATION
  - 0 ALL OTHER FUNCTIONS OCCUR PRIOR TO ENABLING SEPARATION CIRCUITS
  - 0 BOTH WATER IMPACT SENSORS MUST INITIATE SEPARATION SIGNAL
  - 0 QUALIFICATION TESTS AND SYSTEMS CHECKOUT VERIFY PROPER SYSTEM OPERATION

SRB-8

CERTIFICATION/VERIFICATION STATUS

0 NO OPEN CERTIFICATION OF QUALIFICATION

0 NO OPEN HAZARDS/CIL'S

0 NO OPEN WAIVERS

0 NO OPEN UNPLANNED KSC WORK

SRB-9

READINESS STATEMENT

PENDING SATISFACTORY COMPLETION OF NORMAL OPERATIONS FLOW (OHRSD) AND OPEN ITEMS IDENTIFIED, WE CERTIFY THE SRB FLIGHT HARDWARE READY TO SUPPORT MISSION 51-L.

/S/ MR. KILMINSTER

/S/ MR. MURPHY

J. KILMINSTER, MTI  
VICE PRESIDENT  
SPACE BOOSTER PROGRAMS

G. MURPHY, USB1-BPC  
EXECUTIVE VICE PRESIDENT

/S/ MR. SMITH

/S/ MR. MULLOY

J. D. SMITH  
CHIEF ENGINEER, SRB PROJECT

L. B. MULLOY  
MANAGER, SRB PROJECT

SRB-10

0 0 1 0 0 0 0 0



VIII-G

TWR-15284C

FLIGHT READINESS REVIEW  
SRM-24 (STS-61C)  
02 DECEMBER 1985  
L. O. WEAR

FLIGHT READINESS REVIEW  
SRM-24 (STS-61C)

1.0	INTRODUCTION	MSFC
2.0	ELEMENT BOARD REVIEW	MSFC
0	PROBLEM SUMMARY	
3.0	SRM-24 REVIEW	MTI
0	STS-61B (SRM-23) PERFORMANCE	
0	CHANGE SUMMARY	
0	PERFORMANCE PREDICTION	
0	CERTIFICATION/VERIFICATION	
0	PROBLEM SUMMARY TOPICS	
0	FLIGHT READINESS CERTIFICATION	

STS-61B QUICKLOOK EVALUATION  
SRM-23 PERFORMANCE  
(CHART NO. 3-1)

	PREDICTED (73°F)	EVALUATION (73°F)
0 AVERAGE HEAD PRESSURE (5-20 SEC, PSIA)		
0 LEFT MOTOR	901.0	926.2
0 RIGHT MOTOR	899.7	928.7
0 WEB TIME (SEC)		
0 LEFT MOTOR	109.7	108.4
0 RIGHT MOTOR	109.7	108.0
0 ACTION TIME (SEC)		
0 LEFT MOTOR	121.4	121.6
0 RIGHT MOTOR	121.5	120.6
0 SEPARATION COMMAND TIME BASED ON 50 PSIA ON LAST SRM + 5.7 SEC	124.8	123.9
0 PROP. BURN RATE (IPS)		
0 LEFT MOTOR	.372 (.369)*	.374 (.371)*
0 RIGHT MOTOR	.372 (.369)*	.376 (.373)*
* ADJUSTED TO A TEMPERATURE OF 60°F AND PRESSURE OF 625 PSIA		

THE INFORMATION ON THIS PAGE WAS PREPARED TO SUPPORT AN ORAL PRESENTATION

STS-b1B Quick-Look Evaluation  
 SRM-23 Performance  
 SRM-23A and B Thrust vs. VOL X Specification Limits  
 (CHART NO. 3-1A)

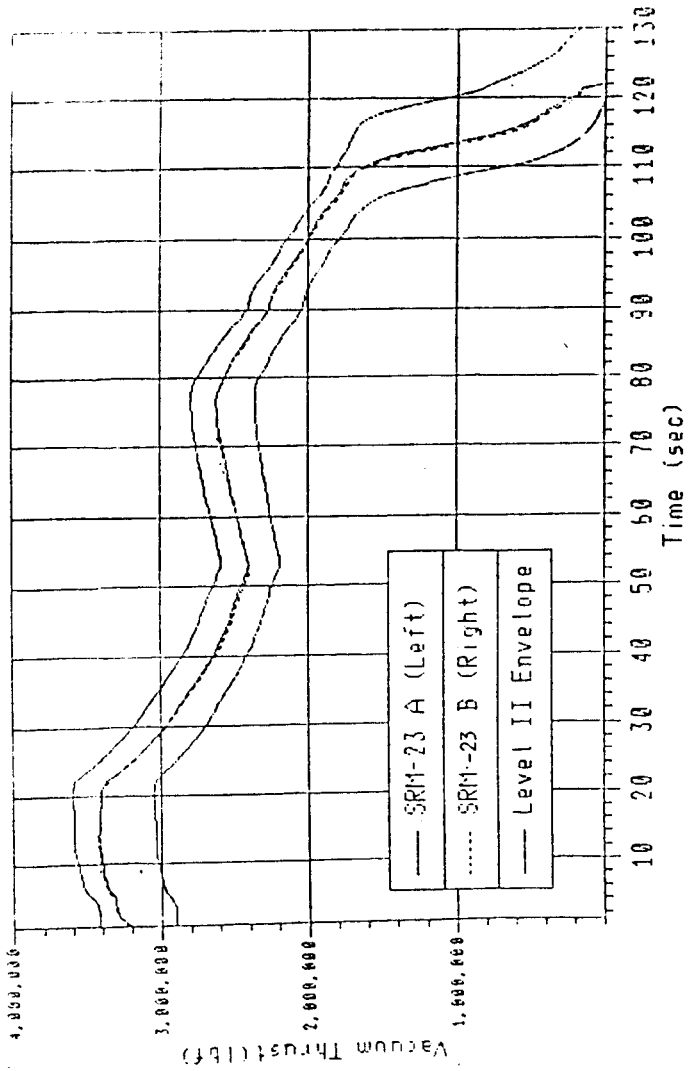

21 104111

STS-61C (STS-32) (SRM-24) QUICK LOOK EVALUATION  
(CHART NO. 3-1B)

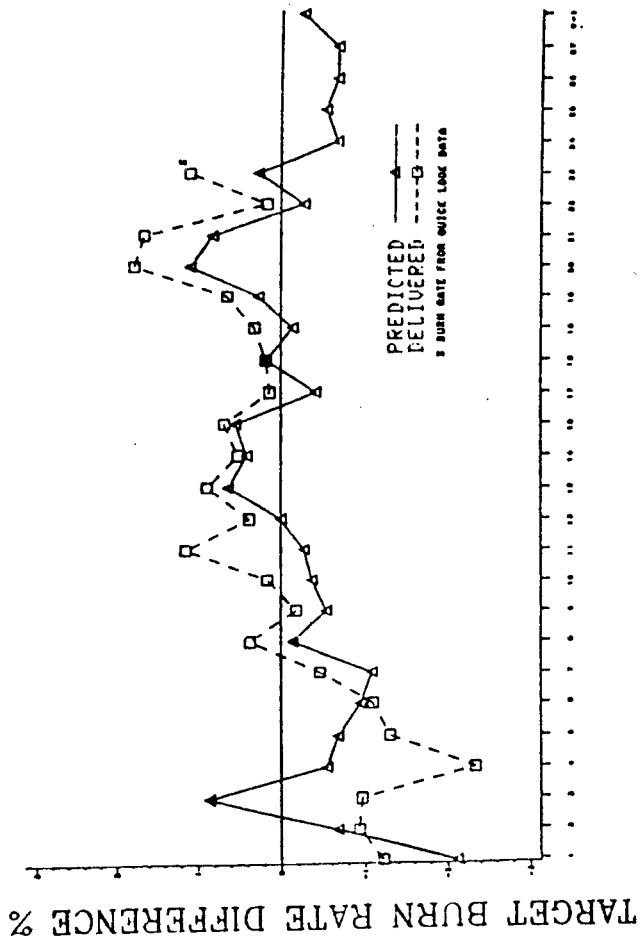

SRM FLIGHT MOTOR SETS

STS-61B (STS-31) (SRM-23) PERFORMANCE  
(CHART NO. 3-2)

<u>PROBLEM</u>	<u>CONCERN</u>	<u>RESOLUTION</u>	<u>TO BE DISCUSSED</u>
ALL THREE STIFFENER RINGS ON BOTH SRM'S EXPERIENCED WATER IMPACT DAMAGE. CRACKS AND BUCKLES OBSERVED IN ALL THE RINGS. RING OF THE 18 STIFFENER RING SEGMENTS WILL HAVE TO BE REPLACED.	REUSE OF SRM HARDWARE	ACCEPTABLE	NO
NO REPORTABLE POCKETS, GOUGES, OR WASHES IN THE INLET RINGS FOR BOTH NOZZLES.	SRM NOZZLE PERFORMANCE	ACCEPTABLE	NO
ALL ABLATIVE RINGS IN PLACE BUT SOME DIS-PLACEMENT FORWARD. APPARENTLY DUE TO WATER IMPACT, HAS CAUSED LOCAL RAISED AREAS AT SOME OF THE RING INTERFACES.	SRM NOZZLE PERFORMANCE	ACCEPTABLE	NO
SOOT OBSERVED ON SRM-23A (LH) AFTER EXIT CONE SEALING SURFACE BUT THERE WAS NO APPARENT DAMAGE TO O-RING.	SRM NOZZLE PERFORMANCE	ACCEPTABLE	NO
SRM-23A (LH) HAD NO GAS PATHS THROUGH THE PUTTY AT ANY FIELD JOINT. (SEE SKETCH ON SUBSEQUENT CHART)	SRM PERFORMANCE	ACCEPTABLE	NO

STS-61B (STS-31) (SRM-23) POST FLIGHT  
(CHART NO. 3-2A)

AFT EXIT CONE

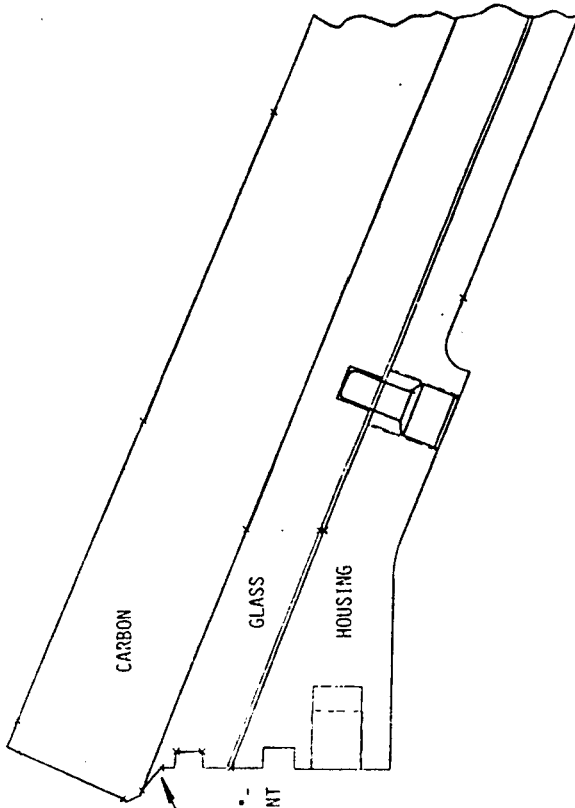

SOOT ON THE  
GLASS, (2) ARCS-  
108°-193° AND 221°-  
285°, JUST IN FRONT  
OF THE O-RINGS.

STS-61B (STS-31) (SRM-23) PERFORMANCE  
(CHART NO. 3-3)

PROBLEM	CONCERN	RESOLUTION	TO BE DISCUSSED
SRM-23B (RH) HAD ONE GAS PATH AT THE AFT/AFT CENTER JOINT AT 58° BUT IT DID NOT PROGRESS TO THE PRIMARY O-RING.	SRM PERFORMANCE	ACCEPTABLE	NO
LH MOTOR NOZZLE JOINT GAS PATH AT 340° SOOT ON ALL SIDES OF O-RING. GROOVE FROM 210.6° - 0° - 176.4° (316.8° TOTAL ARC). SOOT PAST PRIMARY SEAL FROM 325.8° - 354.6° (28.8° TOTAL ARC). SOOT PENETRATED ONLY 1/4 INCH BEYOND PRIMARY SEAL. IT DID NOT TURN CORNER ONTO THE POLAR BOSS. PRIMARY O-RING DAMAGED TO UNKNOWN EXTENT SECONDARY O-RING NOT DAMAGED.	SRM PERFORMANCE	ACCEPTABLE	NO
RH MOTOR NOZZLE JOINT GAS PATH AT 0° SOOT BETWEEN PUTTY AND PRIMARY SEAL FROM 281° - 0° - 212° (291° TOTAL ARC). NO SOOT PAST PRIMARY SEAL. PRIMARY O-RING DAMAGED TO UNKNOWN RADIAL DEPTH. CIRCUMFERENTIAL LENGTH OF MAJOR ERODED REGION IS ABOUT 1 IN. SECONDARY O-RING NOT DAMAGED.	SRM PERFORMANCE	ACCEPTABLE	NO



VIII-H

NSFC PROBLEM ASSIGNMENT SYSTEM  
FEBRUARY 26, 1968

PACKET RECEIVED NUMBER  
44950  
CONTAINER REPORT NUMBER  
DR1-397

**ORIGIN TITLE:** O-RING EROSION IN THE CASE TO NOZZLE JOINT

**PROBLEM:** CONTRACTOR: HYDROCORP

**REPORTING:** WORKING TITLE: STRUCTURE: CRT

**REPORTING OFFICER:** NAME: BARKER

**REPORTING UNIT:** LOCATION: HSC-X

**REPORTING DATE:** CONTRACT: 418L 418L

**REPORTING OFFICER:** PT-FLY INS

**REPORTING OFFICER:** CONCERN: JMI

**REPORTING OFFICER:** 418L 418L

**REPORTING OFFICER:** DATE EFFECTIVE: 11/1/65

**REPORTING OFFICER:** EST RES DATE: 07/29/65

**REPORTING OFFICER:** DATE REC: 07/10/65

**REPORTING OFFICER:** COMB CLUSURE REC: 12/10/65

**REPORTING OFFICER:** MISC CODE: 923

**REPORTING OFFICER:** DATE REC: 07/10/65

**REPORTING OFFICER:** COMB CLUSURE REC: 12/10/65

**REPORTING OFFICER:** MISC CODE: 923

**REPORTING OFFICER:** DATE REC: 07/10/65

**REPORTING OFFICER:** COMB CLUSURE REC: 12/10/65

**REPORTING OFFICER:** MISC CODE: 923

**REPORTING OFFICER:** DATE REC: 07/10/65

**REPORTING OFFICER:** COMB CLUSURE REC: 12/10/65

**REPORTING OFFICER:** MISC CODE: 923

**REPORTING OFFICER:** DATE REC: 07/10/65

**REPORTING OFFICER:** COMB CLUSURE REC: 12/10/65

**REPORTING OFFICER:** MISC CODE: 923

**REPORTING OFFICER:** DATE REC: 07/10/65

**REPORTING OFFICER:** COMB CLUSURE REC: 12/10/65

**PROBLEM DESCRIPTION:**

EXT'S SIGNIFICANT REPORTS - AB7934, AB8299, AB8814, AB8815, AB8827, AB8939, A09740  
INDICATED EROSION HAS DEVELOPED ON THE NET SECTOR OF BOLT HEAD  
A MONTH BEFORE OF THE SECONDARY O-RING SEAL AND A MONTH BEFORE THE UNRECOVERED O-RING  
THIS INDICATES THAT NO GOTT BETWEEN THE PRIMARY & SECONDARY O-RINGS

**SITUATION / RESOLUTION:**

7/11/65 - POST FLY INSPECTION OF BRN 16A REVEALED A GAS PATH THROUGH THE VACUUM PUMP AT SA BIER.  
THE EROSION AT SA BIER WAS IDENTIFIED AS A GAS PATH THROUGH THE VACUUM PUMP AT SA BIER.  
EROSION AT SA BIER WAS IDENTIFIED AS A GAS PATH THROUGH THE VACUUM PUMP AT SA BIER.  
EROSION AT SA BIER WAS IDENTIFIED AS A GAS PATH THROUGH THE VACUUM PUMP AT SA BIER.  
EROSION AT SA BIER WAS IDENTIFIED AS A GAS PATH THROUGH THE VACUUM PUMP AT SA BIER.  
EROSION AT SA BIER WAS IDENTIFIED AS A GAS PATH THROUGH THE VACUUM PUMP AT SA BIER.  
EROSION AT SA BIER WAS IDENTIFIED AS A GAS PATH THROUGH THE VACUUM PUMP AT SA BIER.

4 SA BIER THE SECONDARY O-RING EXTENDED IN 0.25 IN. OF EROSION & THIS CAUSED ADDITIONAL EROSION  
WAS BROKE FOR 25 INCHES OF THE INCLINING EROSION WAS 3.1 IN. WITH NO ADDITIONAL REPAIR APPLIED  
EARTH. THERE WAS NO BOOT PART THE SECONDARY O-RING.

POST FLY INSPECTION OF BRN 16A REVEALED A GAS PATH THROUGH THE VACUUM PUMP AT SA BIER.  
EROSION AT SA BIER WAS IDENTIFIED AS A GAS PATH THROUGH THE VACUUM PUMP AT SA BIER.  
EROSION AT SA BIER WAS IDENTIFIED AS A GAS PATH THROUGH THE VACUUM PUMP AT SA BIER.  
EROSION AT SA BIER WAS IDENTIFIED AS A GAS PATH THROUGH THE VACUUM PUMP AT SA BIER.  
EROSION AT SA BIER WAS IDENTIFIED AS A GAS PATH THROUGH THE VACUUM PUMP AT SA BIER.  
EROSION AT SA BIER WAS IDENTIFIED AS A GAS PATH THROUGH THE VACUUM PUMP AT SA BIER.  
EROSION AT SA BIER WAS IDENTIFIED AS A GAS PATH THROUGH THE VACUUM PUMP AT SA BIER.

BASED ON THE AMOUNT OF EROSION IT WAS BELIEVED THAT THE PRIMARY O-RING & VACUUM IS UNDERSTOOD ABOUT  
THE EROSION AT SA BIER.

**REPORTING OFFICER:** NAME: BARKER

**REPORTING OFFICER:** LOCATION: HSC-X

**REPORTING OFFICER:** CONTRACT: 418L 418L

**REPORTING OFFICER:** DATE EFFECTIVE: 11/1/65

**REPORTING OFFICER:** EST RES DATE: 07/29/65

**REPORTING OFFICER:** DATE REC: 07/10/65

**REPORTING OFFICER:** COMB CLUSURE REC: 12/10/65

**REPORTING OFFICER:** MISC CODE: 923

**REPORTING OFFICER:** DATE REC: 07/10/65

**REPORTING OFFICER:** COMB CLUSURE REC: 12/10/65

**REPORTING OFFICER:** MISC CODE: 923

**REPORTING OFFICER:** DATE REC: 07/10/65

**REPORTING OFFICER:** COMB CLUSURE REC: 12/10/65

**REPORTING OFFICER:** MISC CODE: 923

**REPORTING OFFICER:** DATE REC: 07/10/65

**REPORTING OFFICER:** COMB CLUSURE REC: 12/10/65

PC 037710

NSFC REVIEW COMPLETE  
STATUS OPEN-R

NSFC CLOSURE DATE

PROJECT

R. S. B.A.

REPORTING OFFICER

NOSE PROBLEM APPURTENMENT SYSTEM  
(C O N W N A I J O N)

FILE RECORD NUMBER  
NOSE PROBLEM  
CONTRACTOR REPORT NUMBER  
DR-4-3/49

7/16/45 - THIS PROBLEM IS NOT CONSIDERED A CONSTRAINT TO SIF. A 100 PSID LEAK CHECK IS PERFORMED ON THE SIF AFTER SHUTTING OFF THE GAS SUPPLY TO THE ENGINE. ANY LEAK WILL BE DETECTED BY A PRESSURE DROP IN THE SIF. THE MOST PROBABLE CAUSE OF THIS PROBLEM IS A LEAK IN THE SIF. THE MOST PROBABLE CAUSE OF THIS PROBLEM IS A LEAK IN THE SIF. THE MOST PROBABLE CAUSE OF THIS PROBLEM IS A LEAK IN THE SIF.

REF. TWO WORD "816-SIF BOLD ROCKET MOTOR (SRM 19) FLIT READERS REVULY," DATED 7-1-03, SRM SPECIAL TOPIC, NOZZLE O-RING ANALYSE OBSERVED ON SRM-SIB (SR-1AA) - ---JUN 7-19-45---

7/23/45 UPDATED FROM 7-11-45 PRB - RATIONALE FOR ACCEPTANCE WAS DISCUSSED AS INDICATED BY THE 7-2-45 UPDATE. NO OTHER SIGNIFICANT INFO WAS PROVIDED.

9/27/45 - 816-SIF (SRM-19) FLIT JOINT O-RING INSPECTION REVEALED BEYOND GAP FILLING THROUGH THE JOINT O-RING PROBLEM WAS FOUND ON ANOTHER FLIT. THE NOZZLE TO CASE O-RING JOINT BEYOND A GAS PATH AT 21.6 DEGREE WITH THE PRIMARY O-RING EXPERIENCED EROSION OF APPROX. 0.010 IN. THIS IS WITHIN THE FLIT EXPERIENCE DATA BASE & IS NOT A FLT CONSTRAINT TO S15-S11 (SRM-20) - ---JAN 5 W. THOMAS B-11-051---

8/19/45 UPDATED FROM 8-0-45 PRB - NOTHING NEW TO REPORT AT THIS MEETING.

9/29/45 UPDATED FROM 21 DAY REPORT - RESULTS OF THE LEAK INVESTIGATION ARE THAT THE PRIMARY O-RING FAILED TO SEAL AT 15.5 DEGREE WITH NO GAS FLOWING THROUGH THE JOINT. A PORTION OF THE SECONDARY O-RING THE PRIMARY O-RING & CONTINUED UNTIL IT IMPROVED ON THE SECONDARY O-RING. THE SECONDARY O-RING BEYOND A GAS PATH AT 21.6 DEGREE WITH THE PRIMARY O-RING EXPERIENCED EROSION OF APPROX. 0.010 IN. THIS IS WITHIN THE FLIT EXPERIENCE DATA BASE & IS NOT A FLT CONSTRAINT TO S15-S11 (SRM-20) - ---JAN 5 W. THOMAS B-11-051---

9/20/45 - ON 816-S11 NO O-RING EROSION WAS EXPERIENCED THAT EXCEEDED THE CURRENT EXPERIENCE BASE. THE PRIMARY O-RING ON 816-S11 NO O-RING EROSION WAS EXPERIENCED THAT EXCEEDED THE CURRENT EXPERIENCE BASE.

10/16/45 - ON 816-S11 NO O-RING EROSION WAS EXPERIENCED THAT EXCEEDED THE CURRENT EXPERIENCE BASE. THIS PROBLEM IS NOT A CONSTRAINT TO S15-S11 - ---JAN 5 W. THOMAS B-11-051---

11/6/45 - ON 816-A1A NO O-RING EROSION WAS EXPERIENCED THAT EXCEEDED THE CURRENT EXPERIENCE BASE. THIS PROBLEM IS NOT A CONSTRAINT TO S16-A10 - ---JUN 11-14-45---

12/17/45 - ON 816-A1A NO O-RING EROSION WAS EXPERIENCED ON THE FIELD JOINTS. HOWEVER, A LEAK OF THE PROBLEM WAS EXPERIENCED ON BOTH THE FLIT AND THE SRM. THIS PROBLEM IS NOT A CONSTRAINT TO S16-A10 - ---JUN 12-12-45---

1/23/46 REVOLUTION - SRM FIELD AND NOZZLE JOINTS HAVE EXPERIENCED EROSION OF POST FLIGHT INSPECTION. O-RINGS DURING GENERAL VISUALS AND STATIC TEST AS DETERMINED BY POST FLIGHT INSPECTION.

ROTOR POSITIONING SYSTEM  
(SEE PROBLEM STATEMENT ON P. 4)

TABLE REPORT NUMBER  
AVR210  
CONTRACTOR REPORT NUMBER  
BR41743

THE PRIMARY O-RING IN A NUMBER OF INSTANCES WAS INSUFFICIENTLY DAMAGED AND/OR DISPLACED TO ALLOW EXCESSIVE LEAKS OF THE FLUIDS INTO THE ROTOR COMPARTMENT BUT NO TO THE POINT WHERE THE O-RING SEALING CAPABILITY WAS DEGRADED.

THE CAUSE OF THE O-RING EROSION HAS BEEN ATTEMPTED TO NOT BE KNOWN THROUGH THE VACUUM PUTTY PROBABLY AND SHOULD NOT BE IN CONTACT WITH THE SECONDARY O-RING BECAUSE THE CONTACT OF THE O-RING FOLLOWED IS A FUNCTION OF ORBIT SIZE AND FILL VOLUME (CHECK BETWEEN THE PRIMARY O-RING AND THE PUTTY). USUALLY O-RING EROSION IS EXPECTED TO CONTINUE SINCE NO CORRECTIVE ACTION HAS BEEN INITIATED THAT THE SECONDARY O-RING WILL BE IN CONTACT WITH THE PUTTY SINCE THE PUTTY HAS BEEN TAKEN TO BE THE CAUSE OF THE EROSION. THE SECONDARY O-RING WILL NOT BE IN CONTACT WITH THE PUTTY SINCE THE PUTTY HAS BEEN TAKEN TO BE THE CAUSE OF THE EROSION. THE SECONDARY O-RING WILL NOT BE IN CONTACT WITH THE PUTTY SINCE THE PUTTY HAS BEEN TAKEN TO BE THE CAUSE OF THE EROSION.

THE CLACKING PROBLEMS HAVE BEEN ELIMINATED TO ASSURE ROTOR-TO-ROTOR CONSISTENCY IN JOINT MATING. THE OPERATIONAL MAINTENANCE DOCUMENT CHANGES WERE EFFECTIVE ON BRN 1024 AND BRN 1114. QUALITATIVE STUDIES WERE RUN ON BOTH IMPROVEMENT EROSION AND ROTARY EROSION EXPERIENCE HAS BEEN WITHIN THE PROGRAM DATA BASE.

THE NEW IMPROVEMENT PROGRAM CAN BE INITIATED UNTIL THE PROBLEMS ARE FULLY UNDER CONTROL AND ALL OPERATIONAL STUDIES WERE RUN ON BOTH IMPROVEMENT EROSION AND ROTARY EROSION EXPERIENCE HAS BEEN WITHIN THE PROGRAM DATA BASE. THE NEW IMPROVEMENT PROGRAM CAN BE INITIATED UNTIL THE PROBLEMS ARE FULLY UNDER CONTROL AND ALL OPERATIONAL STUDIES WERE RUN ON BOTH IMPROVEMENT EROSION AND ROTARY EROSION EXPERIENCE HAS BEEN WITHIN THE PROGRAM DATA BASE.

CONSTRAINTS CAN BE MET BY  
PROJECT MANAGER

D O 06771 E

VIII-I

PAID 1 10  
FBI REC'D  
APR 14  
COMM-FBI (4)  
DAY 3 43

DRUG PROFILE ADDRESS: 41  
APR 20 7 13AM

CHUCKER FIELD, BUREAU FIELD PRIMARY D-RING BEAL

CLASSIFIED BY	CLASSIFICATION	DATE	BY	REASON	DATE	BY	REASON
UNCLASSIFIED	UNCLASSIFIED	01/17/04	SP-10	FOIA	01/17/04	SP-10	FOIA
CLASSIFIED BY	CLASSIFICATION	DATE	BY	REASON	DATE	BY	REASON
UNCLASSIFIED	UNCLASSIFIED	02/17/04	SP-10	FOIA	02/17/04	SP-10	FOIA

REF: SIMILAR REPORTS AD014 & AD025, AMMCS, AMMCS, AMMCS, AMMCS, AMMCS  
FIELD CHIR CONDITION ON PRIMARY D-RING BEAL IN FWD FIELD JOINT ON BHP AC7 OF BTU-11 FLT, MISSOURI  
41B

TO: COLUMBIAN / MEMPHIS

MEMPHIS ACTIVITY - MORE BEALS WERE DISCOVERED DURING FLT. THE PRIMARY D-RING BEAL IN THE FWD FIELD JOINT EXHIBITED A CRACKED AREA APPROX 1 IN. LONG, 0.030-0.050 IN. DEEP, & 0.100 IN. WIDE. THIS WAS DISCOVERED DURING POST-FLT BEALING CHECKOUT AT MSC.

AD024 - CONTINUED FLYING FOR BEALING CHECKOUT ON FUTURE FLTS. ANALYSIS INDICATED BEAL SURFACES WERE IN GOOD CONDITION IN THE FLT. BEALING CHECKOUT ESTABLISHED FOR BTU-12. LABORATORY TEST RESULTS REVEALING INTERGRITY AT ZERO PSI BEING AN ORDER WITH A BEALING CHECKOUT DEPTH OF 0.005 IN. THEREAFTER. THIS IS NOT A DEFERRAL TO FUTURE FLIGHTS. ADDRESSING PHO ON 3-16-04.

AD025 - UPDATED FROM 3-16-04 REPORT - THE FAILURE BEING AMMCS WAS A SECONDARY PROB. THE VACUUM CHECKOUT BEING DISCOVERED DURING POST-FLT BEALING CHECKOUT. THE BEALING CHECKOUT BEING DISCOVERED DURING POST-FLT BEALING CHECKOUT. THE BEALING CHECKOUT BEING DISCOVERED DURING POST-FLT BEALING CHECKOUT.

AD026 - UPDATED FROM 3-16-04 REPORT - THE FAILURE BEING AMMCS WAS A SECONDARY PROB. THE VACUUM CHECKOUT BEING DISCOVERED DURING POST-FLT BEALING CHECKOUT. THE BEALING CHECKOUT BEING DISCOVERED DURING POST-FLT BEALING CHECKOUT. THE BEALING CHECKOUT BEING DISCOVERED DURING POST-FLT BEALING CHECKOUT.

AD027 - UPDATED FROM 3-16-04 REPORT - THE FAILURE BEING AMMCS WAS A SECONDARY PROB. THE VACUUM CHECKOUT BEING DISCOVERED DURING POST-FLT BEALING CHECKOUT. THE BEALING CHECKOUT BEING DISCOVERED DURING POST-FLT BEALING CHECKOUT. THE BEALING CHECKOUT BEING DISCOVERED DURING POST-FLT BEALING CHECKOUT.

APPROVAL	DATE	BY	REASON
UNCLASSIFIED	01/17/04	SP-10	FOIA

APPROVAL: J. FLETCHER  
DATE: 02/17/04  
BY: SP-10  
REASON: FOIA

PAGE 2 OF 4  
 MFC RECORD NUMB"  
 A07934  
 CORRECTOR SETUP  
 044-0730

MFC PROBLEM ASSIGNMENT SYSTEM  
 ( c o n t i n u e d )

9/1/84 UPDATED FROM 21-DAY REPORT - THE FORWARD FIELD JOINT DESIGN IS BEING EVALUATED. IT HAS BEEN DETERMINED THAT THE FREE VOLUME, THAT PORTION OF THE JOINT END OF THE PRIMARY O-RING NOT FILLED WITH EITHER VACUUM PUTTY OR GREASE, IS WHERE THE PROB LIEG. IT IS BELIEVED THAT THE O-RING CHAIR IS SUBJECT TO SHORT TIME DURATION IMPINGEMENT OF A HIGH ENERGY JET WHICH IS INDUCED DURING IGNITION PREBURST. A COMBINATION OF WORDS IN THE PROTECTIVE VACUUM PUTTY & THE FILLING OF AVAILABLE FREE VOLUME IS CITED. THE EFFECT OF POTTING PARTS & THE O-RING BLOT. THE TEST BEING CONDUCTED SHOULD VERIFY THAT THIS CONDITION WILL NOT CAUSE A SERIOUS PROB.

9/23/84 UPDATED FROM 9-10-84 PRO - INVESTIGATIONS ARE CONTINUING. O-RING DAMAGE IS NOT TO THE POINT WHERE SEAL INTEGRITY WOULD FAIL (LESS THAN 0.090 IN. POSSIBLE). O-RING CHAIR HAS ALSO BEEN FOUND ON 818-13.

9/30/84 UPDATED FROM MAY MONTHLY SUMMARY REPORT - TWR-14236 "PERFORMANCE CHARACTERISTICS OF THE SRH O-RING ASBY TEST PLAN" HAS BEEN RELEASED & THE 3 IN. CP HOT TESTING INITIATED. DATA FROM THE TEST IS BEING ANALYZED & WILL BE IN NEXT MONTH'S REPORT.

6/20/84 UPDATED FROM 6-14-84 PRO & JUNE MONTHLY SUMMARY REPORT - PRELIMINARY FINDINGS FROM THE O-RING TEST CONFIRM THE HOT JET IMPINGEMENT OCCURRING & THE MAJOR CONCLUSIONS DRAWN ARE:

1. O-RING EROSION IS A FUNCTION OF ORIFICE SIZE & FREE VOLUME.
2. GREASE ON THE O-RING IMMEDIATELY INCREASES EROSION.
3. NO DAMAGE TO THE O-RING RESULTS WHEN THE ORIFICE IS ABSENT, DIMINUTING THE ABSENCE OF VACUUM PUTTY.

A METHOD OF SOLUTION HAS NOT BEEN DETERMINED. THIKKUL WILL HAVE RECOMMENDED CHANGES IN JULY 1984. A07934, A08014 & A08299 DOCUMENT DIFFERENT OCCURRENCES OF THE SAME GENERAL PROB. ALL ANALYSES DONE & CONCLUSIONS MADE WILL APPLY TO ALL 3 OCCURRENCE & WILL BE REPORTED UNDER A07934 HENCEFORTH. 7/10/84 CORRECTED AT PRO ON 7-12-84 - TWO SPECs WERE RELEASED CHANGING THE LAYOUT OF THE VACUUM PUTTY & GREASE APPLICATION. THESE CHANGES WERE TESTED SATISFACTORILY, HOWEVER ADDITIONAL TEST ARE REQ'D.

9/24/84 UPDATED FROM AWD. MONTHLY SUMMARY REPORT & 9-13-84 PRO - VACUUM SEAL PUTTY LAYOUT SPECs 8147-3193 & 8147-3220 WITH NEW LAYOUT PROCEDURES HAVE BEEN RELEASED. 8147-3194 IS BEING RELEASED IN THE SIGN OFF PHASE. INVESTIGATIONS ARE CONT'G. PLANS ARE TO PERFORM FULL SCALE BUZZLE & LEAK TESTS. ALSO LOOKING AT NEW PUTTY. THIS PROBLEM OCCURRED AGAIN ON FLT 410. SEE PROBLEM REPORT A08613.

10/2/84 UPDATED FROM SEPT. MONTHLY SUMMARY REPORT - VACUUM SEAL PUTTY LAYOUT SPEC 8147-3220 HAS BEEN REVISED TO REDUCE THE AMOUNT OF GREASE & 8147-3194 IS STILL IN SIGN OFF.

11/8/84 UPDATED FROM OCT. MONTHLY SUMMARY REPORT - THE JOINT FILLER NTR. TEST PLAN IS RELEASED & FULL SCALE JOINT ASBY TESTING WAS INITIATED 10-10-84 AT HORTON THICKOL'S H7 CLEARFIELD FACILITY.

11/14/84 UPDATED FROM PAU HTU 11-9-84 - THE TEST PLAN SHOULD BE REVISED & TEST STARTED WITHIN APPROX. 2 WKS.

1/2/85 UPDATED FROM PRO HTU 12-10-84 - A NEW PROGRAM WAS REQUESTED BY MFC FOR EVALUATION & TESTING. THIS IS NOW IN WORK & THE ESTIMATED COMPLETION DATE IS 1-4-85. ANY DESIGN CHANGES ARE PENDING THE

PC 037597

PAGE 3 OF 6  
 MFC RECORDING MI  
 CONTRACTOR REP  
 BR4-8/30

MFC PROBLEM RESOLUTION SYSTEM  
 (S E R V I C E I N I T I A T I V E)

TEST RESULTS. A COPY OF THE 40-LB & 5 IN. CP MOTOR TEST SCHEDULE IS INCLUDED IN THIS PAGE. THE O-RING CHAM PROBLEM IS A REVIEW ITEM FOR EACH FLT READINESS REVIEW (FRR).

1/22/85 UPDATED FROM PRO MTG ON 1-10-85 - ALL SCALE MODEL TESTING WILL BE COMPLETED IN JAN. FULL SCALE TESTS ARE TO FOLLOW.

2/15/85 UPDATED FROM 3-7-84 FRR & JAN. MONTHLY BURNARY REPORT - TESTING OF VACUUM SEAL PUTTY LAYUP CONFU. USING 5 IN. CP MOTOR IS CONTINUING. TONGH TESTS HAVE BEEN DONE ON ARBUSTOS FILLED PUTTY PER'D BY RANDOLPH & INHOPT & A NONSUBSTIT PUTTY PER'D BY INHOPT. BOTH ARBUSTOS PUTTIES PERFORMED COMPARABLY. THE HEAT TRANSPER RATE OF THE NONSUBSTIT PUTTY WAS MORE THAN TWICE THAT OF THE ARBUSTOS FILLED PUTTY. FURTHER CHAM. TEST MOTORS ARE SCHEDULED TO FURTHER TEST THE PUTTY TYPES.

EROSION WAS AGAIN EXPERIENCED ON FLT 51C. THE O-RING RUBBS WERE AS BAD OR WORSE THAN PREVIOUSLY EXPERIENCED. SEE PROBLEM REPORT ADR439/CONT. NO. 4-2/41. DESIGN CHANGES ARE PENDING TEST RESULTS. CHANGES BEING CONSIDERED ARE: MODIFYING THE O-RINGS, DOUBLE BARRIER VENTING & ADDING GREASE AROUND O-RINGS TO FILL THE VOID LEFT BY THE PUTTY.

3/18/85 UPDATED FROM 3-7-84 FRR - TESTING & EVALUATION PROGRAM IS CONTINUING. DESIGN CHANGES ARE PENDING TEST RESULTS.

3/25/85 UPDATED FROM FEB. MONTHLY BURNARY REPORT - DISABBY OF THE BRM 17A & 17B NOZZLE TO AFT CAUSE JOINTS REVEALED GAS PATHS THRU THE PUTTY AT 109 DEG & 24 DEG. RESPECTIVELY. BOTH PRIMARY O-RINGS HAD HEAT AFFECTED GASES (NO EROSION) AT THE GAS PATH LOCATIONS. ROOT CAUSE FOUND BETWEEN THE O-RINGS & THE PUTTY. DESIGN CHANGES ARE BEING MADE TO PREVENT THIS FROM OCCURRING. THE ROOT WAS MOST LIKELY DEPOSITED DURING IGNITION PREBURIALIZATION WHEN GAS PRESSED THE PRIMARY O-RINGS BEFORE THEY BEATED.

A DR4-5 PROBLEM REPORT WAS NOT WRITTEN FOR THIS OCCURRENCE FOR THE FOLLOWING REASONS:

- 1) THE PRIMARY O-RINGS HEATED & THE PRESSURE INTEGRITY OF THE JOINTS WAS MAINTAINED.
- 2) THE O-RINGS WERE NOT ERODED.
- 3) GAS PATHS & O-RING EROSION HAVE OCCURRED ON PREVIOUS FLTS & ARE EXPECTED TO OCCUR RANDOMLY ON FUTURE FLTS.

IT HAS BEEN REPORTED HERE TO DOCUMENT THE OCCURRENCE.

4/17/85 UPDATED FROM PRO MEETING 4-11-85 - O-RING INVESTIGATION & PUTTY TESTING IS CONTINUING.

MFC'S FINDING THAT THE PUTTY DEBATED IN UREANE COULD NOT BE DUPLICATED BY THINKOL.

4/24/85 UPDATED FROM APRIL MONTHLY BURNARY REPORT - AT HADA REQUEST, A SOLUTION FOR O-RING EROSION WILL NOT INVOLVE A RADICAL DESIGN CHANGE. THEREFORE, THE POSSIBLE SOLUTIONS UNDER CURRENT INVESTIGATION ARE LIMITED TO:

1. NEW O-RING MTL AND/OR CHARACTER.
2. NEW VACUUM PUTTY AND/OR LAYUP PROCEDURE.
3. DISABBY OF BRM 17A & 17B NOZZLES TO AFT CAUSE JOINTS REVEALED GAS PATHS THRU THE PUTTY AT 109 DEG & 24 DEG. RESPECTIVELY. BOTH PRIMARY O-RINGS HAD HEAT AFFECTED GASES (NO EROSION) AT THE GAS PATH LOCATIONS. ROOT CAUSE FOUND BETWEEN THE O-RINGS & THE PUTTY. DESIGN CHANGES ARE BEING MADE TO PREVENT THIS FROM OCCURRING. THE ROOT WAS MOST LIKELY DEPOSITED DURING IGNITION PREBURIALIZATION WHEN GAS PRESSED THE PRIMARY O-RINGS BEFORE THEY BEATED.

D O O 6 7 0 0 0 B

PAGE 4 OF  
 AFSC REPORT NO.  
 007934  
 CONTRACTOR RE  
 ORA-5730

MOFC PROBLEMS AND REMEDY  
 (O P T I N U A T I O N)

- 0-RING GROOVES OF EACH JOINT. HOWEVER, NO ROOT CAUSED THE PRIMARY 0-RING.
- 6/29/65 UPDATED FROM 6-13-65 PHB - PLAN TO GRAVE 0-RING FAST THE .093 IN. TO DETERMINE WHEN A LEAK WILL OCCUR. HOT FIRE JOINT TESTS ARE PLANNED FOR AUG., 1965.
- 7/16/65 UPDATED FROM JULY MONTHLY SUMMARY REPORT DATED 6-17-65 - ONE POSSIBLE EXPLANATION FOR THE GREATER EROSION OBSERVED ON BRD 170 (60 MILS) & M18 (7 MILS) RELATES TO AN ASPECT OF THE ECCENTRIC NOZZLE JOINT CAN OCCUR MORE EASILY THAN AN ECCENTRIC FIELD JOINT DUE TO A) ITS HORIZONTAL POSITION, B) POSITION DURING ASSEMBLY, C) SMALL JOINT CLEARANCE, AND C) THE ABSENCE OF GAITER. CONSEQUENTLY, IT IS POSTULATED THAT A REDUCED JOINT GAP (4 THEREFORE GAS JET ORIFICE) OCCURRED AT THE CIRCUMFERENTIAL LOCATION OF THE BLOWHOLE, THEREBY CAUSING ENHANCED EROSION. THE VOLUME FILLING MODEL PREDICTS AN ECCENTRICITY OF ONLY 7 MILS WILL RAISELY DOUBLE THE 40 MILS EROSION PREDICTED FOR CONCENTRIC EXCEEDING 00 MILS CAN BE CAUSED BY JOINT ECCENTRICITY IF THE REDUCED GAP ALIGNS WITH THE BLOWHOLE. INVESTIGATION OF THIS SCENARIO IS CONTINUING.
- 7/23/65 UPDATED FROM 7-11-65 PHB - THIS PROBLEM WAS SCHEDULED FOR STATUING, BUT NOT DISCUSSED SINCE NO SIGNIFICANT PROBLEMS HAD BEEN MADE SINCE THE LAST UPDATE.
- 8/19/65 UPDATED FROM 8-9-65 PHB & JULY 1965 MONTHLY SUMMARY REPORT - THE ANALYTICAL MODEL OF 0-RING EROSION HAS BEEN USED TO PREDICT A WORST CASE EROSION OF 72 MILS ON THE SECONDARY 0-RING SINCE THE PRIMARY 0-RING FEELER HAS BEEN REMOVED TO DEAL WITH THE PROBLEM OF SIMULATED EROSION & SUBSCALE MOTOR FEELER INVESTIGATION THAT THIS IS WELL BELOW THE SEAL CAPABILITY OF 0-RINGS. EVALUATION OF THE RESULTS OF 819-31P ARE CONTINUING.
- 9/3/65 UPDATED FROM JULY MONTHLY SUMMARY REPORT DATED 8-12-65 - DS-1-3/48 (A09260) REPORTED .089 INCH OF EROSION OBSERVED IN THE NOZZLE TO CASE JOINT ON DEVELOPMENT MOTOR NO. 7.
- ORA-5749 (A09260) REPORTED .171 IN. OF EROSION ON PRIMARY 0-RING & .032 IN. OF EROSION ON THE SECONDARY 0-RING IN THE NOZZLE TO CASE JOINT OF BRM 16A.
- THE INVESTIGATIONS ARE CONTINUING & WILL BE REPORTED HERE AS THEY ARE THE SAME GENERIC PROBLEM.
- INSPECTION OF BRM 16A FIELD WITHIN REVEALED NO EROSION HOWEVER, THE NOZZLE TO CASE JOINT HAD PRIMARY 0-RING EROSION AT 171.2 DECS WITH A MAXIMUM DEPTH OF .013 IN. BRM 16B HAD NO FIELD JOINT EROSION THE NOZZLE TO CASE JOINT EXPERIENCED NO EROSION AT 63, 93.6, 270 & 342 DECS. THE PRIMARY 0-RING WAS ERODED ONLY AT 270 & 342 DECS WITH ONLY 10% OF THE 0-RING REMAINING. A PROBLEM REPORT HAD NOT WRITTEN FOR THESE OCCURRENCES SINCE THEY WERE WITHIN RESTORABLE LEVELS. THEY ARE REPORTED HERE FOR INFORMATION.
- 10/2/65 UPDATED FROM AUGUST MONTHLY SUMMARY REPORT DATED 10-16-65 - BRM 16B (810-31P) EXPERIENCED A SHOT BLOWBY AT 21.6 DECS. AT THIS LOCATION THE 0-RING WAS ERODED APPROX. 0.001 IN. WELL WITHIN THE EXPERIENCE BASE. OH-5 WILL BE DELAYED TO ALLOW FOR DEVELOPMENT OF 0-RING SOLUTION.
- 11/4/65 UPDATED FROM OCTOBER MONTHLY SUMMARY REPORT & 10-17-65 PHB - ANALYSIS OF DATA FROM 818-91J & OH-5 TEST ARE IN WORK.
- 11/19/65 UPDATED FROM 11-7-65 PHB MEETING. 818-61A EXPERIENCED NO FIELD JOINT EROSION, HOWEVER, SHOT BLOWBY WAS FOUND ON 3 OF THE 6 PRIMARY 0-RINGS. 818-61A R.H. NOZZLE EXPERIENCED EROSION OF THE PRIMARY 0-RING. THE EROSION WAS WELL WITHIN THE CURRENT DATA BASE.

PC  
 037599

PAGE 7 OF 6  
 THIS RECORD HAS  
 BEEN REPRODUCED  
 EXACTLY AS SUBMITTED  
 UNLESS OTHERWISE NOTED

MGFC PROBLEM-RESOLUTION SYSTEM  
 (CONTINUATION)

BASED ON THE JOINT PUTTY & O-RING PROBLEM, A PROGRAM WAS INITIATED TO ESTABLISH ACCEPTABLE MATERIALS & CONFIGURATION THAT COULD BE TESTED ON W-3 & ULTIMATELY INCORPORATED IN FLIGHT MOTORS.

15/17/95 - UPDATE FROM NOVEMBER MONTHLY SUMMARY REPORT.  
 THE O-RING TASK FORCE HAS STARTED ASSEMBLY AND COULD FLOW TESTING OF NOZZLE PUTTY AND JOINT FILLERS. TESTING IS CONTINUING.

SRM 21 - NO DAMAGE  
 SRM 22 - RIGHT HAND (81) NOZZLE

THERE WAS EROSION AT 97.2 DEGREE. IT WAS .075 INCH DEEP AND HAD 16.2 DEGREE OF CROSS SECTIONAL PERIMETER AFFECTED WITH 13 INCHES OF HEAT DAMAGE LENGTH AND 23 INCHES OF HEAT AFFECTED LENGTH. THIS IS NOT THE WORST CASE TO DATE. THERE WAS NO OTHER REPORTED O-RING DAMAGE.

12/20/95 UPDATED FROM 12-12-95 PDU MEETING - THIRDS IS CONTINUING STUDIES RELATING TO THE O-RING EROSION AND PUTTY LAYUP ON AN ON-GOING BASIS. A TOTAL SOLUTION TO THE PROBLEM IS LONG AWAY. HOWEVER, AN ACCEPTABLE DATA BASE HAS BEEN ESTABLISHED AND SUFFICIENT MANAGEMENT HAS BEEN MADE TO PROVIDE THE NECESSARY CONTROL TO PREVENT RECURRENTS OF THE PROBLEM OUTSIDE THE ESTABLISHED DATA BASE. CLOSURE PAPER HAS BEEN PREPARED AND IS BEING EVALUATED.

1/20/96 UPDATED FROM DECEMBER MONTHLY SUMMARY REPORT. THE TASK FORCE HAS MADE ONE HOT GAS TEST. THE PRELIMINARY RESULTS INDICATE THAT THE TEST CHAMBER NEEDS TO BE REDESIGNED.

SPACE SHUTTLE 60M FLIGHT SET 23 WAS LAUNCHED NOVEMBER 27. INSPECTION OF THE FIELD JOINTS REVEALED NO DAMAGE. WHILE BOTH OF THE NOZZLE-TO-CASE JOINTS HAD EROSION.

SRM	23A	23B
EROSION LENGTH (INCHES)	3.0	7.0
HEAT AFFECTED LENGTH (INCHES)	22.0	35.0
EROSION DEPTH (INCHES)	.017	
DEGREE LOCATION	346 DEGREES	0 DEG

1/23/96 REVOLUTION - 60M FIELD AND NOZZLE JOINTS HAVE EXPERIENCED EROSION OF THE PRIMARY O-RING DURING SEVERAL FLIGHTS. THE CAUSE OF THE EROSION HAS NOT YET BEEN DETERMINED BY POST FLIGHT INSPECTION. THE PRIMARY O-RING DESIGN OF THE MOTOR WAS SUFFICIENTLY ADVANCED AND/OR REPLACED TO ALLOW BLIGHTY EROSION. THE SECONDARY O-RING TO HOT COMBUSTION UNDER. SOME EROSION WAS OBSERVED ON THE SECONDARY O-RING AT THE NOZZLE JOINT BUT NOT TO THE POINT WHERE THE O-RING SEALING CAPABILITY WAS JEOPARDIZED.  
 THE CAUSE OF THE O-RING EROSION HAS BEEN ATTRIBUTED TO HOT GAS FLOW THROUGH THE VACUUM PUTTY FOLLOWING THE HOT GASES TO IMPINGE UPON THE O-RING. IMPROPER BEATING OF THE PRIMARY O-RING ALLOWED BLOWBY AND MINOR HOT GAS IMPINGEMENT ON THE SECONDARY O-RING. THE PROXIMITY OF THE O-RING EROSION IS A FUNCTION OF ORIFICE SIZE AND FLOW VOLUME (AREA BETWEEN THE PRIMARY O-RING AND THE PUTTY).

PRIMARY O-RING EROSION IS EXPECTED TO CONTINUE SINCE NO CORRECTIVE ACTION HAS BEEN ESTABLISHED THAT WILL PREVENT HOT GAS FLOW THROUGH THE PRIMARY O-RING CAVITY. STEPS HAVE BEEN TAKEN TO ASSURE THAT THE SECONDARY O-RING WILL BE SEATED AND ANALYTICAL ANALYSIS HAVE INDICATED THAT UNDER A WORST CASE SITUATION, EROSION OF THE SECONDARY O-RING WILL NOT BE REVERSE ENOUGH TO ALLOW A LEAK PATH PAST THE SECONDARY O-RING. ST47-2747 WAS CHANGED EFFECTING AN INCREASE IN THE LEAK CHECK PRESSURE FROM

PC 037600



HPFC PROBLEM ADJUDICATION SYSTEM  
(S O N T I N U U M C I O N)

FORM: 6 HP 6  
HPFC RECORD M1  
A07934  
CONTRACTOR REF  
DN4-5/30

AND PATHS TO 200 P810. WITH THE 100 P810 LEAK TEST THE SECONDARY O-RINGS WOULD BE BEATEN BUT ANY 200 P810. ANY LEAK PATH THROUGH THE POTTY WOULD BE DETECTABLE. THE 200 P810 LEAK TEST WAS IMPLEMENTED ON 80R-19 AND SUBSEQUENT POTIONS.

THE STACKING PROCEDURES HAVE BEEN CLASSIFIED TO ASSURE MAINT-TU-MOTOR CONSISTENCY IN JOINT MATING. THE OPERATIONAL MAINTENANCE DOCUMENT CHANGES WERE EFFECTIVE ON 80R 1024 AND 80R8.

ANALYTICAL STUDIES BASED ON BOTH IMPROVEMENT EXHIBIT AND JUDGMENT EXHIBIT SHOW THAT THIS PHENOMENON HAS AN ACCEPTABLE RISKING SINCE IMPLEMENTING THE ABOVE CHANGES. RECENT EXPERIENCE HAS BEEN WITHIN THE PROGRAM DATA BASE.

THIS SEAL IMPROVEMENT PROGRAM PLAN WILL CONTINUE UNTIL THE PROBLEM HAS BEEN ISOLATED AND DOMAINS ELIMINATED TO THE 80R BEALS. STATUS WILL CONTINUE TO BE PROVIDED IN THE FLIGHT READINESS REVIEW AND IN FORMAL TECHNICAL REVIEWS. ALL HPFC. AT THE CONCLUSION OF THE PROGRAM, A COMPREHENSIVE REPORT WILL BE WRITTEN TO CONSOLIDATE THE RESULTS, CONCLUSIONS, AND RECOMMENDATIONS.

THIS PROBLEM IS CONSIDERED CLOSED BASED ON M1 REPORT TWA-14209, REV. A, "IMPROVEMENTS OF BIPACE 0-RING EXHIBIT BEALS" DATED 0-20-85 AND M1 LETTER E150/80R-86-114 "RATIONALE FOR CLOSURE OF THE 0-RING EXHIBIT PROBLEM", A07934, DN4-5/30, DATED 1-2-86.

## VIII-J

George C. Marshall Space Flight Center  
Marshall Space Flight Center, Alabama  
35894

[SEP 15 1980

Copy to Attn of SA01

TO: Distribution  
FROM: SA01/Mr. Lindstrom  
SUBJECT: Assigning Launch Constraints on Open Problems  
Submitted to MSFC PAS -

The Shuttle Projects Office has established a requirement for identification of launch constraints for problems being reported to the MSFC Problem Assessment System (PAS) by element contractors. Each element contractor (Rocketdyne, MMC, USBI, and Thiokol) has been directed to support this requirement by providing launch constraint information on each new problem submitted to the MSFC PAS. The launch constraint information provided by the contractor is based upon their preliminary technical evaluation and will require final concurrence by the responsible element project manager.

a. The following guidelines have been established to aid in making constraint decisions on open problems and are limited to recurrence control determination only. In accordance with practices established on past programs, remedial actions (e.g. removal and replacement of defective hardware, etc.) for correcting discrepancies on the vehicle to be launched are considered launch constraints and are tracked by the KSC system.

(1) All open problems coded criticality 1, 1R, 2, or 2R will be considered launch constraints until resolved (recurrence control established and its implementation effectivity determined) or sufficient rationale, i.e., different configuration, etc., exists to conclude that this problem will not occur on the flight vehicle during prelaunch, launch, or flight.

(2) Problems coded criticality 3 will not be considered launch constraints unless (a) the potential exists of leading to a criticality 1 or 2 failure mode; or (b) the failed component has multiple use on the element and more than one occurrence could lead to a criticality 2 condition; or (c) the failure could result in multiple loss of flight instrumentation channels. If a criticality 3 is determined to be a launch constraint, it will be treated the same as a. (1) above.

b. To assure that each reported problem is reviewed for correct criticality and constraint assignment by the appropriate MSFC personnel, the following procedure will be followed:

(1) The responsible S&E design actionee and the element project office actionee will review each problem upon receipt to assure that the criticality and constraint assignments meet with their approval. Exceptions to criticality or constraint assignment will be coordinated with the Problem Assessment Center (PAC) actionee within two working days from receipt of the problem report.

(2) The Problem Assessment Center will prepare a weekly constraints list by element. This list will be submitted to the Shuttle R&QA Support Office, EG03, for input to the Shuttle Projects Manager, SA01. Copies of the constraint list will be furnished concurrently to each Shuttle Element Project Manager.

(3) Launch constraints will be reviewed at each Problem Review Board (PRB) meeting.

The Problem Assessment Center will be responsible for coordinating all launch constraint activity and assuring that information is properly documented in the Problem Assessment System (PAS) data base and transmitted to MSFC management.



Robert E. Lindstrom  
Manager  
Shuttle Projects Office

Distribution:  
See page 3

## Distribution:

CS01/R. Henritze  
 CS11/J. Jordan/R. Mize/R. Penny/P. Moore  
 EA01/J. Kingsbury  
 EC01/F. Moore  
 EC12/A. Henry/E. Paschal/J. Shirey  
 EC14/W. Karigan/J. Burson/S. Boyle/J. Lewis/J. McEuen  
 EC22/E. Fikes/L. Morgan  
 EC23/J. Goldstein/T. Escue/E. Thompson/J. Douglas/  
     R. Holder/W. White  
 EC24/R. Bynum  
 EC25/C. Cornelius/C. Martin  
 EC33/L. Malone/D. Stone/L. Thomas/L. Bell/D. Harris  
 EC41/E. Garrett  
 EC42/D. Williams/J. Blanche/C. Souther/B. McPeak  
 ED01/G. Hopson  
 EE01/F. Wojtalik  
 EE11/W. Horton/R. Butler/W. Jackson/T. McKay/W. Mann/J. Roach/  
     J. Appling/R. Henry/J. Rowell/J. Rountree/V. Henson/  
     L. Sommers  
 EE21/W. Mitchell/J. Thomson/C. Smith  
 EE31/E. Bryan/B. Davis/L. Guzinsky/L. Mulloy/R. Zagrodzky  
 EE51/G. Eudy/F. Uptagrafft  
 EF01/J. Powell  
 EF12/J. Gattis  
 EF13/J. Clubb/M. Camp/C. Morris/M. Goode/E. Seiler  
 EF36/C. Cozelos  
 EG01/C. Brooks  
 EG03/E. Hendricks/J. Madole/E. Smith/E. Mintz/W. Earrell  
 EG21/G. Butler  
 EG22/T. Turner/R. Donaldson/H. Wiggins/R. Kelly/Q. Soprano/  
     R. Jackson/J. Gross/R. Riemer  
 EG23/E. Hoard/D. Herda/D. Gladish/A. Torruella  
 EG24/E. Lowe/J. Davis/E. Baker/B. Nunnelley  
 EH01/R. Schwinghamer  
 EL01/T. Isbell  
 EP01/A. McCool  
 EP13/C. Gaines/E. Engler/W. Harrison  
 EP14/H. Nein/R. White/R. Beck/R. Runkle/R. Dotson/W. Bell  
 EP21/O. Goetz/G. Smith/E. Jacobs  
 EP22/R. Rodgers  
 EP23/F. Pitsenberger/E. Stinson/C. Ratliff/D. Pryor/R. Counts  
 EP25/J. Hester/J. Niblett  
 EP31/G. Geller  
 EP32/M. Leberman  
 EP33/F. Cunningham/C. Hoover/J. Potter/R. Hughes/J. Potter/  
     R. Burns/V. Neiland/W. Dunaway/W. Langson/L. Hein  
 EP35/T. Bechtel/F. Jankowski  
 EP43/E. Hyde/J. Pratt

## Distribution: (Cont'd)

EP44/R. Fisher/J. Vaniman  
 ES81/W. Vaughan  
 ET01/E. Cagle  
 SA31/J. Odom/P. Bridwell  
 SA32/R. Abraham/C. Cavalaris/C. Crane/M. Pessin  
 SA32/D. Newman  
 SA41/W. Rice/G. Hardy  
 SA43/J. Strickland/D. Andrews  
 SA51/J. R. Thompson, Jr./L. Wear  
 SA52/M. Bryant/J. Eaton/B. Mitchell/B. Morris/J. Sloan/  
 J. Splawn/R. Weesner  
 SA49/Brigham City/E. Skrobiszewski  
 SM21/MAF/M. Marchese  
 SA99/Canoga Park/R. Tjulander  
 EG03/Canoga Park/B. Pagenkopf  
 SK-QAL/T. Bridges/J. Hughes/J. Cook  
 SK-SRB/J. King

Rockwell/Hsv/R. Strand/J. Fletcher/B. Cox/G. Miller/  
 W. McGahee/M. Glass/O. Burnett/R. Roberts/  
 J. Ash/C. Newton/R. Saliba/B. Gonterman/  
 P. Pollack

VIII-K

SECTION 5.1 EXTERNAL TANK SUBSYSTEMS

PAR. 10 Nos. 741, 756, and Ground Measurement Nos. 660, 614, 610

JAN 1-1-5

.....

PC 001853

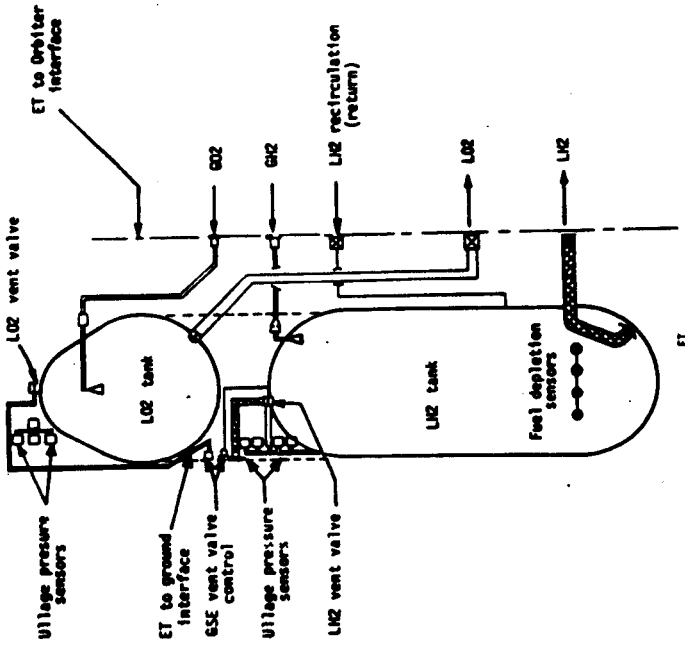

PC 003354

TEST NO.	TEST DESCRIPTION	TIME	TEST TIME	TEST DATE	TEST TIME	TEST DATE	TEST TIME	TEST DATE
1011100000	Case comp loop	1	45	126	7	7		
1011100000	Case comp loop	1	43	136				
			(1)					

Free Prior to Start of Qualicum to 3-3 Mile  
 (1) Mileage may be exceeded for up to 10 minutes.

For confirmed instrumentation test switch to backup and continue (A).

TEST FOR NAME: NETWORK; C: 1000 F: 1000  
 NAME: 1000; 1000; 1000; 1000; 1000; 1000

TESTING RESTRICTIONS:  
 1. All test office pressure transducers calibrated to 107  
 2. Avoid ice build-up at nose cone fairing exit  
 3. Maximum  
 A. Project CP/ASC in cable tray  
 B. LOR drape pressure transducers  
 C. SLA long term bond line exposure  
 (1) 107

Max	Min
107	107
107	107

TESTING RESTRICTIONS:  
 1. Ice build-up and possible impact to Orbiter  
 2. Inaccurate drape pressure readings  
 3. Possible saturation of CP/ASC and loss of vehicle  
 4. Handling of SLA

TESTING RESTRICTIONS:  
 1. Sensor malfunction.  
 2. Regulator malfunction.  
 3. Sample pump flow.  
 4. Sample pump air is closed.  
 5. Check filter.

TESTING RESTRICTIONS:  
 (A) The following ground pump loops are backup monitoring loops:  
 1. Main engine fuel pump loop  
 2. Main engine oxidizer pump loop  
 3. Main engine oxidizer pump loop  
 4. Main engine oxidizer pump loop  
 5. Main engine oxidizer pump loop  
 6. Main engine oxidizer pump loop  
 7. Main engine oxidizer pump loop  
 8. Main engine oxidizer pump loop  
 9. Main engine oxidizer pump loop  
 10. Main engine oxidizer pump loop  
 11. Main engine oxidizer pump loop  
 12. Main engine oxidizer pump loop  
 13. Main engine oxidizer pump loop  
 14. Main engine oxidizer pump loop  
 15. Main engine oxidizer pump loop  
 16. Main engine oxidizer pump loop  
 17. Main engine oxidizer pump loop  
 18. Main engine oxidizer pump loop  
 19. Main engine oxidizer pump loop  
 20. Main engine oxidizer pump loop  
 21. Main engine oxidizer pump loop  
 22. Main engine oxidizer pump loop  
 23. Main engine oxidizer pump loop  
 24. Main engine oxidizer pump loop  
 25. Main engine oxidizer pump loop  
 26. Main engine oxidizer pump loop  
 27. Main engine oxidizer pump loop  
 28. Main engine oxidizer pump loop  
 29. Main engine oxidizer pump loop  
 30. Main engine oxidizer pump loop  
 31. Main engine oxidizer pump loop  
 32. Main engine oxidizer pump loop  
 33. Main engine oxidizer pump loop  
 34. Main engine oxidizer pump loop  
 35. Main engine oxidizer pump loop  
 36. Main engine oxidizer pump loop  
 37. Main engine oxidizer pump loop  
 38. Main engine oxidizer pump loop  
 39. Main engine oxidizer pump loop  
 40. Main engine oxidizer pump loop  
 41. Main engine oxidizer pump loop  
 42. Main engine oxidizer pump loop  
 43. Main engine oxidizer pump loop  
 44. Main engine oxidizer pump loop  
 45. Main engine oxidizer pump loop  
 46. Main engine oxidizer pump loop  
 47. Main engine oxidizer pump loop  
 48. Main engine oxidizer pump loop  
 49. Main engine oxidizer pump loop  
 50. Main engine oxidizer pump loop  
 51. Main engine oxidizer pump loop  
 52. Main engine oxidizer pump loop  
 53. Main engine oxidizer pump loop  
 54. Main engine oxidizer pump loop  
 55. Main engine oxidizer pump loop  
 56. Main engine oxidizer pump loop  
 57. Main engine oxidizer pump loop  
 58. Main engine oxidizer pump loop  
 59. Main engine oxidizer pump loop  
 60. Main engine oxidizer pump loop  
 61. Main engine oxidizer pump loop  
 62. Main engine oxidizer pump loop  
 63. Main engine oxidizer pump loop  
 64. Main engine oxidizer pump loop  
 65. Main engine oxidizer pump loop  
 66. Main engine oxidizer pump loop  
 67. Main engine oxidizer pump loop  
 68. Main engine oxidizer pump loop  
 69. Main engine oxidizer pump loop  
 70. Main engine oxidizer pump loop  
 71. Main engine oxidizer pump loop  
 72. Main engine oxidizer pump loop  
 73. Main engine oxidizer pump loop  
 74. Main engine oxidizer pump loop  
 75. Main engine oxidizer pump loop  
 76. Main engine oxidizer pump loop  
 77. Main engine oxidizer pump loop  
 78. Main engine oxidizer pump loop  
 79. Main engine oxidizer pump loop  
 80. Main engine oxidizer pump loop  
 81. Main engine oxidizer pump loop  
 82. Main engine oxidizer pump loop  
 83. Main engine oxidizer pump loop  
 84. Main engine oxidizer pump loop  
 85. Main engine oxidizer pump loop  
 86. Main engine oxidizer pump loop  
 87. Main engine oxidizer pump loop  
 88. Main engine oxidizer pump loop  
 89. Main engine oxidizer pump loop  
 90. Main engine oxidizer pump loop  
 91. Main engine oxidizer pump loop  
 92. Main engine oxidizer pump loop  
 93. Main engine oxidizer pump loop  
 94. Main engine oxidizer pump loop  
 95. Main engine oxidizer pump loop  
 96. Main engine oxidizer pump loop  
 97. Main engine oxidizer pump loop  
 98. Main engine oxidizer pump loop  
 99. Main engine oxidizer pump loop  
 100. Main engine oxidizer pump loop

PC 001855  
 )



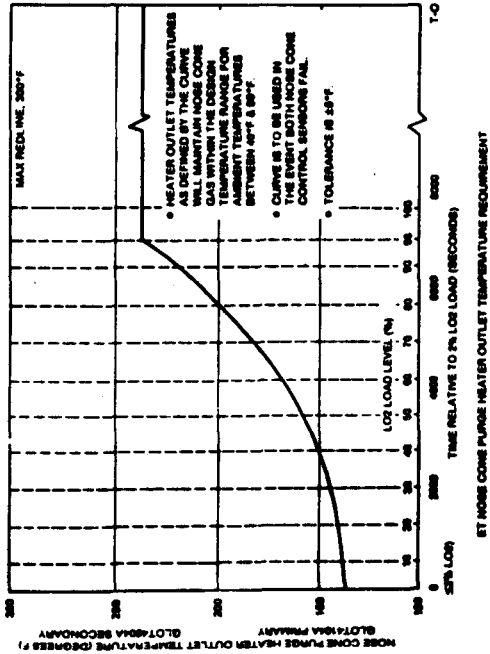

S.1-46 REV C APR 68 12

PC 00135/  
\*\*\*\*\*

VIII-L

DATE:

SAFETY REQUIREMENTS DOCUMENTATION LIST STS-381

NUMBER: W80107  
 DRAWN: ET (CLM)  
 CHECKED: LCC PHASE 5.1-4/verify ET nose cone AgC (Queso for 600-552)  
 SPECIFICATION: STS 381

REQ. NO.	DESCRIPTION	TECHNICAL RATIONALE
(PR 1) 381.018(7)	NOSE CONE TEMP. EXCESS THE LCC LOW LIMIT TEMP. 1/2 45°F. TEMP MONITOR 33% <del>MONITORING</del> <del>MONITORING</del>	NO VISIBLE ICE BUILDUP ON THE NOSE CONE FRAMES SURF AREA. TEMPERATURE IS 12°F BELOW BEHALVE. FOR STS-33 RIV. LCC ACCEPTABLE IS 28°F (WAS 45°F) ULLAGE TRANSDUCERS ARE ACCEPTABLE DOWN TO 28°F (WAS 40°F) REFER. NOTE A LCC 5.1-4

PART NAME  
 ET NOSE CONE MON  
 (ET Anti-ice Probe)  
 32-0189-17

DRAWING NUMBER  
 7940714

QTY & SERIAL NUMBER  
 1

APPROVALS

*[Signature]* 1/1/86  
 REQUESTED BY: RE *[Signature]* 12/1/86  
 BY: *[Signature]* 1/27/86  
 DESIGN OFFICE: *[Signature]* 1/27/86  
 FOR THE: *[Signature]* 1/27/86  
 DATE: *[Signature]* 1-17-86  
 LIST RE (EXCEPTION ONLY)

5686

SUBMIT DATE: \_\_\_\_\_  
 CONSTRAINT: \_\_\_\_\_  
 REC. NUMBER: \_\_\_\_\_  
 LONG III PROJECT OFFICE ENCLOSURE:  
 PART " " NUMBER: *[Signature]*